

## Contents

Features.....	1
Applications .....	1
Block Diagram.....	1
Pin Assignment.....	2
Absolute Maximum Ratings .....	2
Electrical Characteristics.....	2
Test Circuits .....	3
Operation .....	4
Selection of External Parts .....	6
Standard Circuits.....	9
Application Circuit .....	9
Notes on Design.....	10
Dimensions.....	10
Markings .....	11
Taping .....	12
Characteristics .....	13

The S-8437/8438 Series is a CMOS inverting switching regulator that consists of a reference voltage source, a CR oscillation circuit, a power MOS FET and an error amplifier. For the S-8437AF, the output voltage is fixed internally and it easily forms an inverting switching regulator with shutdown function; using an external coil, a diode and a capacitor. For the S-8438AF, any output voltage can be set under the condition of  $V_{IN} \leq 20 - |-V_{OUT}|$  by mounting two external resistors in addition to the external coil, diode, and capacitor. Both are suitable for use as power sources for portable devices because of their small 5-pin package (SOT-89-5), low current consumption and few external parts.

■ Features

- Low current consumption: (S-8437AF)  
 Operation : 13  $\mu$ A typ.  
 Shutdown : 0.1  $\mu$ A max.
- High-precision output voltage:  
 -5 V  $\pm$  3.5% (S-8437AF)
- Any voltage can be set by mounting two external resistors (S-8438AF).
- Built-in CR oscillation circuit:  
 Oscillation frequency: 50 kHz typ.
- Built-in power MOS FET
- 5-pin SOT-89-5 small package

■ Applications

- Power supply for portable equipment, such as pagers, electronic calculators, and remote controllers
- Constant voltage power for LCDs and analog circuits
- Power supply for communications equipment, such as cordless phone and portable telephone

■ Block Diagrams

1. S-8437AF

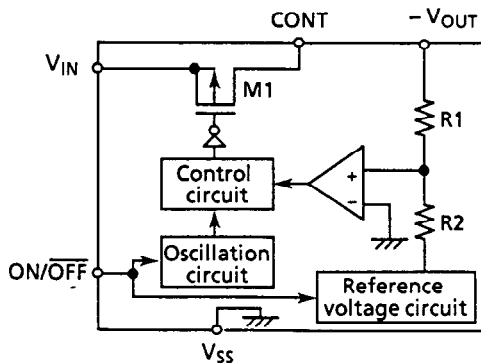

2. S-8438AF

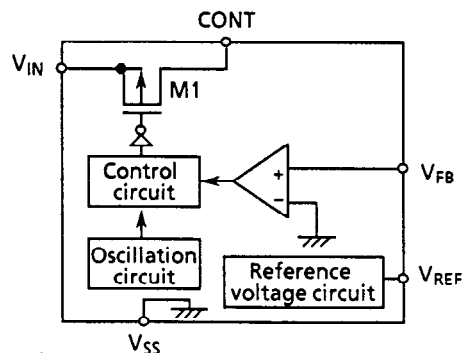

Figure 1

# INVERTING SWITCHING REGULATORS

## S-8437/8438 Series

### Pin Assignment

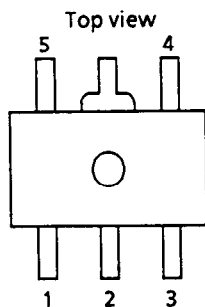

Figure 2

Table 1

Terminal name	S-8437	S-8438	Description
1	CONT		Power MOS FET drain terminal
2	V <sub>SS</sub>		Ground terminal
3	ON/OFF	V <sub>FB</sub>	ON/OFF : Shutdown input terminal V <sub>FB</sub> : Feedback voltage input terminal
4	-V <sub>OUT</sub>	V <sub>REF</sub>	-V <sub>OUT</sub> : Negative output voltage terminal V <sub>REF</sub> : Reference voltage output terminal
5	V <sub>IN</sub>		Positive power input voltage terminal

### Absolute Maximum Ratings

Table 2

(Unless otherwise specified : Ta = 25°C)

Parameter	Symbol	Applicable terminal	Rating	Unit
Input power voltage	V <sub>IN</sub>		13	V
Input terminal voltage	V <sub>term</sub>	V <sub>FB</sub> , ON/OFF	V <sub>SS</sub> - 0.3 to V <sub>IN</sub> + 0.3	V
Output terminal voltage	-V <sub>OUT</sub>		V <sub>IN</sub> ≤ 20 -  -V <sub>OUT</sub>	V
CONT output current	I <sub>CONT</sub>		700	mA
Power dissipation	P <sub>D</sub>		500	mW
Operating temperature	T <sub>opr</sub>		-40 to +85	°C
Storage temperature	T <sub>stg</sub>		-40 to +125	°C

### Electrical Characteristics

#### 1. S-8437AF-ZA-X

Table 3

(Unless otherwise specified : Ta = 25°C)

Parameter	Symbol	Conditions	Min.	Typ.	Max.	Unit	Test cir.
Input power voltage*	V <sub>IN</sub>		2	—	10	V	1
Output voltage**	-V <sub>OUT</sub>	V <sub>IN</sub> = 5 V, I <sub>OUT</sub> = 10 mA	-4.825	-5.000	-5.175	V	1
Line regulation	ΔV <sub>OUT1</sub>	V <sub>IN</sub> = 3 to 10 V, I <sub>OUT</sub> = 10 mA	—	35	160	mV	1
Load regulation	ΔV <sub>OUT2</sub>	V <sub>IN</sub> = 5 V, I <sub>OUT</sub> = 10 μA to 15 mA	—	20	100	mV	1
Output voltage temperature coefficient	$\frac{\Delta V_{OUT}}{\Delta T_a}$	T <sub>a</sub> = -40°C to +85°C	—	± 0.38	—	mV/°C	1
Current consumption	I <sub>SS</sub>	V <sub>IN</sub> = 5 V, V <sub>OUT</sub> = -7 V	—	13	28	μA	2
Current during power-off	I <sub>ST</sub>	V <sub>IN</sub> = 5 V, ON/OFF = L	—	—	0.1	μA	2
Oscillation frequency	f <sub>OSC</sub>	V <sub>IN</sub> = 5 V	30	50	70	kHz	—
Switching current	I <sub>SW</sub>	V <sub>IN</sub> = 5 V, CONT = 4 V	—	150	—	mA	—
Shutdown input terminal input voltage	V <sub>SH</sub>	V <sub>IN</sub> = 5 V, ON/OFF = H	2.4	—	—	V	2
	V <sub>SL</sub>	V <sub>IN</sub> = 5 V, ON/OFF = L	—	—	0.4	V	2
Output voltage during shutdown	V <sub>OUTOF</sub>	V <sub>IN</sub> = 5 V, ON/OFF = L R <sub>L</sub> = 100 Ω	—	—	0.1	V	1

\* The following equation shall be met: V<sub>IN</sub> ≤ 20 - |-V<sub>OUT</sub>|

\*\* External parts:

Coil: RCH654-101K (100μH) manufactured by Sumida Electronics, or equivalent

Diode: DINS4 manufactured by Shindengen, or equivalent

If you need output voltages other than above, contact our Sales Department.

2. S-8438AF-ZB-X

**Table 4**

(Unless otherwise specified : Ta = 25°C)

Parameter	Symbol	Conditions	Min.	Typ.	Max.	Unit	Test cir.
Input power voltage*	V <sub>IN</sub>		2	—	10	V	3
Line regulation	ΔV <sub>OUT1</sub>	V <sub>IN</sub> = 3 to 10 V, V <sub>OUT</sub> = -5 V I <sub>OUT</sub> = 10 mA	—	35	160	mV	3
Load regulation	ΔV <sub>OUT2</sub>	V <sub>IN</sub> = 5 V, V <sub>OUT</sub> = -5 V I <sub>OUT</sub> = 10 μA to 15 mA	—	20	100	mV	3
Reference voltage	V <sub>REF</sub>	V <sub>IN</sub> = 5 V	1.176	1.200	1.224	V	4
Reference voltage temperature coefficient	$\frac{\Delta V_{REF}}{\Delta T_a}$	T <sub>a</sub> = -40°C to +85°C	—	± 0.07	—	mV/°C	4
Current consumption	I <sub>SS</sub>	V <sub>IN</sub> = 5 V, V <sub>FB</sub> = -0.3 V	—	9	19	μA	4
Oscillation frequency	f <sub>OSC</sub>	V <sub>IN</sub> = 5 V	30	50	70	kHz	—
Switching current	I <sub>SW</sub>	V <sub>IN</sub> = 5 V, CONT = 4 V	—	150	—	mA	—

\* The following equation shall be met: V<sub>IN</sub> ≤ 20 - |-V<sub>OUT</sub>|

■ **Test Circuits**

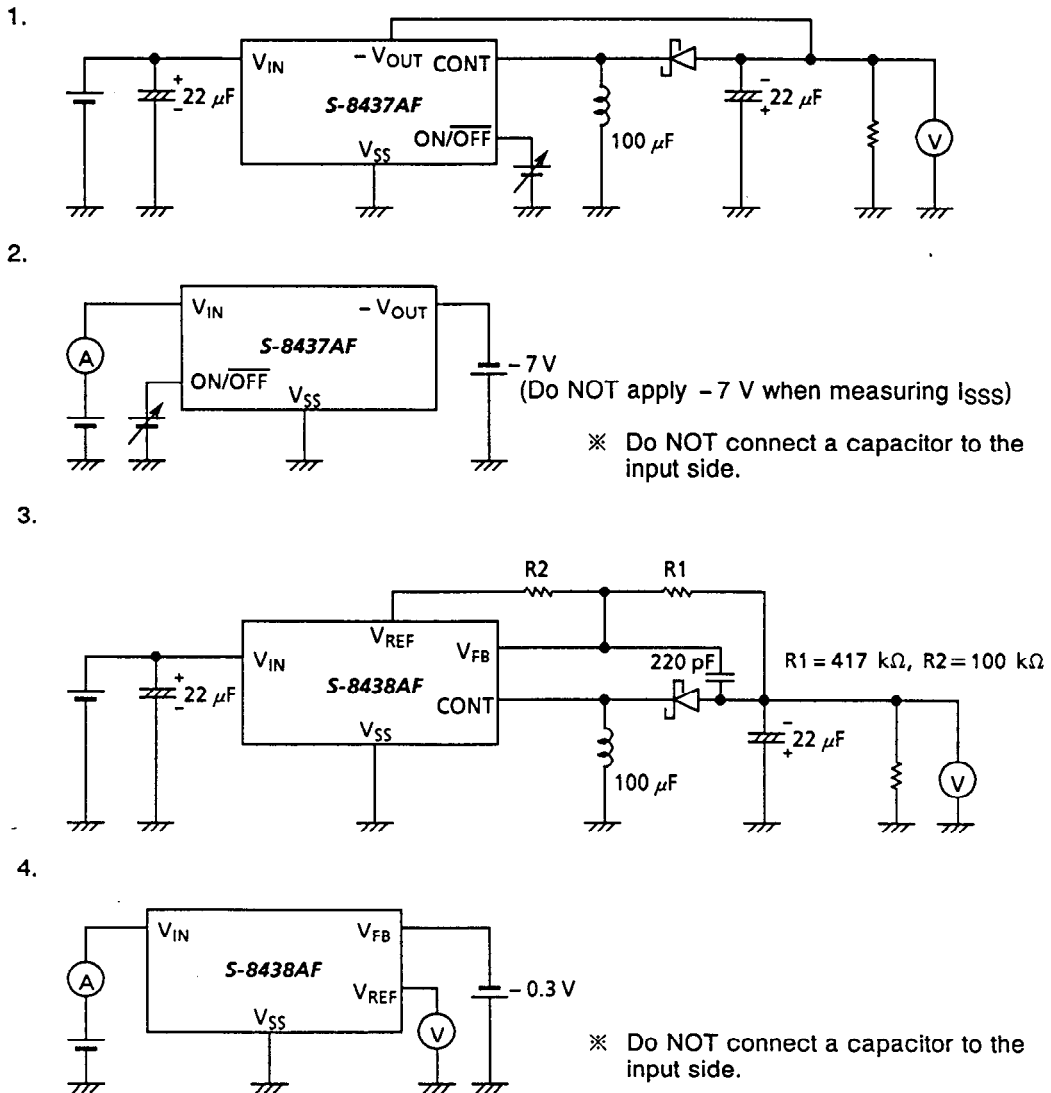

Figure 3

# INVERTING SWITCHING REGULATORS

## S-8437/8438 Series

### ■ Operation

The S-8437/8438 Series consists of a power MOS FET (M1) and a CR oscillation circuit. M1 is turned on and off by the CR oscillation circuit. When M1 is on ( $t_{ON}$ ), energy is accumulated in the inductor (L). When M1 is off ( $t_{OFF}$ ), the accumulated energy is transferred to the  $-V_{OUT}$  capacitor ( $C_{OUT}$ ) through the diode.

CR oscillation circuit : Oscillator by a capacitor and a resistor. The oscillating frequency is 50 kHz typ.

Reference voltage circuit : Can obtain the reference voltage output of  $1.2\text{ V} \pm 2\%$ .

Power MOS FET M1 : In the S-8437/8438 Series, the switching transistor consists of a large Pch power MOS FET. The MOS FET enables much higher-speed switching than a bipolar transistor. The MOS FET can be driven with gate charge and discharge currents. Thus a high-efficient DC-DC converter with few switching losses and low power consumption can be made.

Shutdown terminal (S-8437AF only) : The reference voltage circuit and CR oscillation circuit can be stopped or started by turning the shutdown terminal to L or H. The input voltage level can meet the TTL level (L:0.4 V max., H:2.4 V min.).

Table 5

ON/OFF	Description
"L"	All circuit currents are disconnected when oscillation stops (0.1 $\mu\text{A}$ max.).
"H"	Reversal booster operation.

NOTE: Do NOT use the shutdown terminal in the floating status.

The basic equations of the inverting switching regulators are shown below.

Voltage at A when M1 is on (current  $I_L$  flowing in L is zero):

$$V_A = V_{IN} - V_S \quad \dots\dots\dots (1)$$

( $V_S$  : M1 non-saturation voltage)

Change by time of  $I_L$ :

$$\frac{dI_L}{dt} = \frac{V_L}{L} = \frac{V_{IN} - V_S}{L} \quad \dots\dots\dots (2)$$

Integral ( $I_L$ ) of the above equation:

$$I_L = \left( \frac{V_{IN} - V_S}{L} \right) \cdot t \quad \dots\dots\dots (3)$$

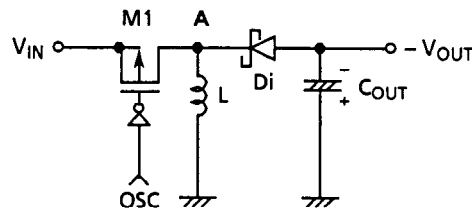

Figure 4  
Inverting switching regulator

This  $I_L$  flows at  $t_{ON}$ . This time is determined by the OSC oscillation frequency.

Peak current ( $I_{PK}$ ) in  $t_{ON}$ :

$$I_{PK} = \left( \frac{V_{IN} - V_S}{L} \right) \cdot t_{ON} \quad \dots\dots\dots (4)$$

In this case, the energy accumulated in L is indicated by  $\frac{1}{2}L (I_{PK})^2$ .

Then, when M1 is off, the energy accumulated in L is transferred to the ground, capacitor, and diode (Di), and a reverse voltage ( $V_L$ ) is generated.

$V_L$  is as follows:

$$V_L = -(V_{OUT} + V_D) \quad \dots\dots\dots (5)$$

( $V_D$  : Forward voltage of diode Di)

Change by the time of  $I_L$  that flows to  $-V_{OUT}$  through the capacitor at  $t_{OFF}$ :

$$\frac{dI_L}{dt} = \frac{V_L}{L} = \frac{V_{OUT} + V_D}{L} \dots\dots (6)$$

Integral of the above equation:

$$I_L = I_{PK} - \left( \frac{V_{OUT} + V_D}{L} \right) \cdot t \dots\dots (7)$$

In  $t_{ON}$ , energy is accumulated in L and is not transferred to  $V_{OUT}$ . Capacitor ( $C_{OUT}$ ) energy is used for a load current ( $I_{OUT}$ ) from  $-V_{OUT}$ . As a result,  $C_{OUT}$  terminal voltage decreases, and this voltage becomes a minimum in  $t_{ON}$ . If M1 is off, the energy accumulated in L is transferred to  $C_{OUT}$  through the diode, and  $C_{OUT}$  terminal voltage increases rapidly.  $V_{OUT}$  voltage indicates a maximum value (ripple voltage:  $V_{PP}$ ) when the current that flows to  $V_{OUT}$  through the diode matches the constant load current  $I_{OUT}$ .

Then this ripple voltage is derived.

$I_{OUT}$  when  $t_1$  is the time period until  $V_{OUT}$  reaches the maximum value after  $t_{ON}$ :

$$I_{OUT} = I_{PK} - \left( \frac{V_{OUT} + V_D}{L} \right) \cdot t_1 \dots\dots (8)$$

$$\therefore t_1 = (I_{PK} - I_{OUT}) \cdot \left( \frac{L}{V_{OUT} + V_D} \right) \dots\dots (9)$$

Considering  $I_L = 0$  occurs (all inductor energy is transferred) in  $t_{OFF}$ , equation (7) becomes:

$$\left( \frac{L}{V_{OUT} + V_D} \right) = \frac{t_{OFF}}{I_{PK}} \dots\dots (10)$$

Substituting (10) into (9):

$$t_1 = t_{OFF} - \left( \frac{I_{OUT}}{I_{PK}} \right) \cdot t_{OFF} \dots\dots (11)$$

The amount of charge  $Q_1$  charged in  $C_{OUT}$  at  $t_1$ :

$$\begin{aligned} \Delta Q_1 &= \int_0^{t_1} I_{OUT} dt = I_{PK} \cdot t_1 - \frac{V_{OUT} + V_D}{L} \cdot \int_0^{t_1} t dt \\ &= I_{PK} \cdot t_1 - \frac{V_{OUT} + V_D}{L} \cdot \frac{1}{2} t_1^2 \dots\dots (12) \end{aligned}$$

Substituting (12) into (9):

$$\Delta Q_1 = I_{PK} - \frac{1}{2} (I_{PK} - I_{OUT}) \cdot t_1 = \frac{I_{PK} + I_{OUT}}{2} \cdot t_1 \dots\dots (13)$$

The voltage ( $V_{PP}$ ) that is raised by  $\Delta Q_1$ :

$$V_{PP} = \frac{\Delta Q_1}{C_{OUT}} = \frac{1}{C_{OUT}} \cdot \left( \frac{I_{PK} + I_{OUT}}{2} \right) \cdot t_1 \dots\dots (14)$$

When  $I_{OUT}$  consumed for  $t_1$  is considered:

$$V_{PP} = \frac{\Delta Q_1}{C_{OUT}} = \frac{1}{C_{OUT}} \cdot \left( \frac{I_{PK} + I_{OUT}}{2} \right) \cdot t_1 - \frac{I_{OUT} \cdot t_1}{C_{OUT}} \dots (15)$$

Substituting (11) into (15):

$$V_{PP} = \frac{(I_{PK} - I_{OUT})^2}{2I_{PK}} \cdot \frac{t_{OFF}}{C_{OUT}} \dots\dots (16)$$

■ **Selection of External Parts**

1. Inductor

To reduce the loss due to the DC resistance, select an inductor with as small a DC resistance as possible (less than 1 Ω). Select the best inductance for the application.

To make the average value of the output voltage (-V<sub>OUT</sub>) constant, the inductor must supply energy equivalent to the output current (I<sub>OUT</sub>). The amount of charge required for I<sub>OUT</sub> is I<sub>OUT</sub> × (t<sub>ON</sub> + t<sub>OFF</sub>). The inductor can supply energy only during t<sub>OFF</sub>, thus the amount of charge is obtained as I<sub>PK</sub>/2 × t<sub>OFF</sub> by integrating equation (7) by 0 → t<sub>OFF</sub>. Therefore:

$$\frac{I_{PK}}{2} \cdot t_{OFF} = I_{OUT} \times (t_{ON} + t_{OFF}) \dots\dots\dots (17)$$

$$\therefore I_{PK} = 2 \cdot \frac{t_{ON} + t_{OFF}}{t_{OFF}} \cdot I_{OUT} \dots\dots\dots (18)$$

Since the oscillation duty ratio of the OSC is 50% and I<sub>PK</sub> equals 4 × I<sub>OUT</sub> if t<sub>ON</sub> = t<sub>OFF</sub>, the I<sub>PK</sub> current flowing in the transistor must be four times of I<sub>OUT</sub>. I<sub>PK</sub> is limited due to the characteristics of the M1 transistor (700 mA max.).

In the S-8437/8438 Series, 39 to 820 μH of inductance is recommended.

Using an inductor with a small L value increases I<sub>PK</sub> and I<sub>OUT</sub>. Accordingly, the minimum operating voltage is lowered, but efficiency decreases. This state is shown in Figures 5 to 7.

Using an inductor with a large L value decreases I<sub>PK</sub> and I<sub>OUT</sub>. Since the energy accumulated in the inductor is ½L(I<sub>PK</sub>)<sup>2</sup>, I<sub>PK</sub> decreases in steps of squares offsetting the increase of L, and the energy decreases overall. Accordingly, stepping up at low voltages is difficult and the minimum operating voltage must be specified as a high value. However, the DC resistance loss in L and the M1 transistor becomes small because of the reduced I<sub>PK</sub>, and the efficiency is improved overall. As indicated in the equation (16), the ripple voltage can be reduced by decreasing I<sub>PK</sub>. Figures 8 to 10 show the output voltage waveforms when the L value and C<sub>OUT</sub> value are changed.

**Note** Too large an I<sub>PK</sub> causes magnetic saturation depending on the core material, resulting in destruction of the IC chip. Always keep I<sub>sat</sub> higher than I<sub>PK</sub> (I<sub>sat</sub>: level of current that causes magnetic saturation).

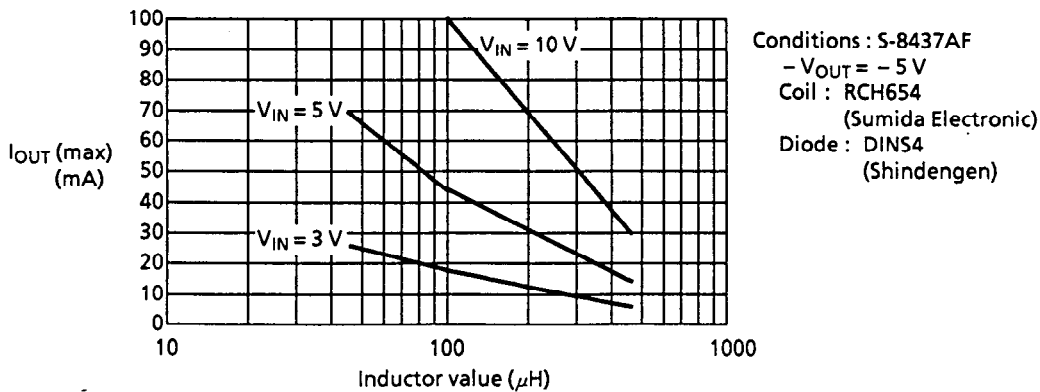

Figure 5 Inductor value - maximum output current \*

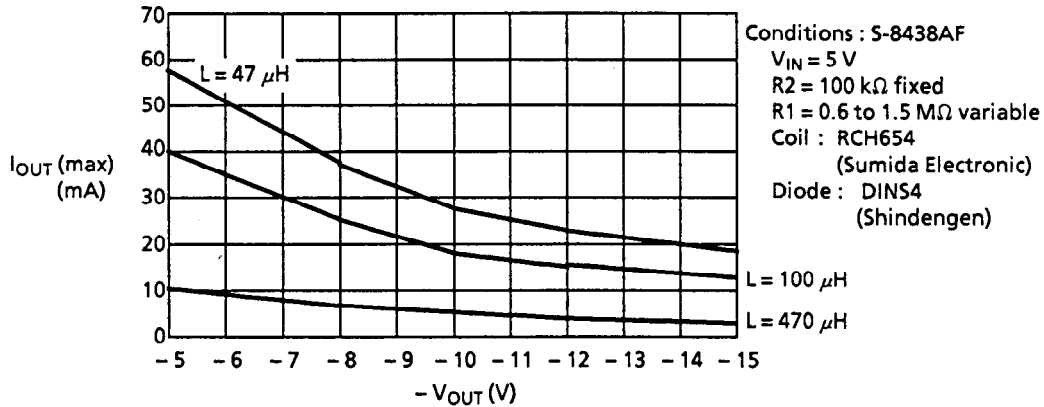

Figure 6 Output voltage – maximum output current \*

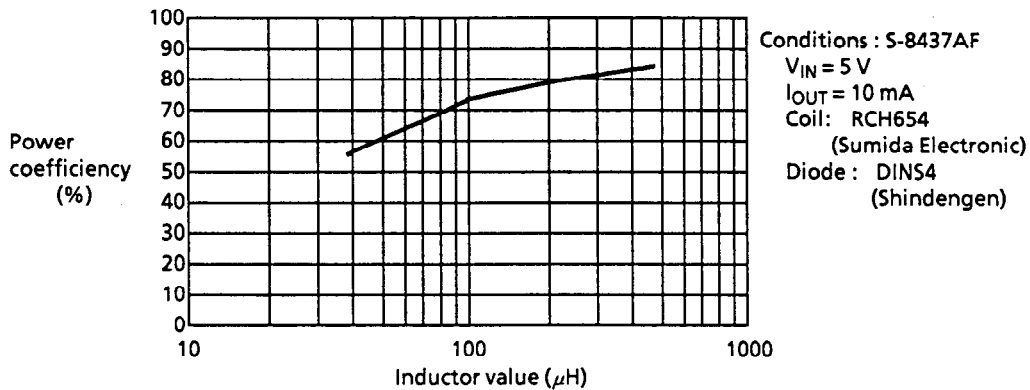

Figure 7 Inductor value – power efficiency

\* The maximum output current ( $I_{OUT(MAX)}$ ) is defined as the output current ( $I_{OUT}$ ) when an output voltage ( $-V_{OUT2}$ ) can be obtained that is 325 mV lower than the output voltage ( $-V_{OUT1}$ ) when the output current ( $I_{OUT}$ ) is  $10\mu\text{A}$ .

## 2. Diode

Use the external diode that meets the following conditions :

- Low forward voltage ( $V_F < 0.3\text{ V}$ )
- Fast switching rate (500 ns max.)
- Backward voltage of  $V_{IN} + |-V_{OUT}|$  or more
- Current rating of  $I_{PK}$  or more

## 3. Capacitors ( $C_{IN}$ and $C_{OUT}$ )

The input capacitor ( $C_{IN}$ ) reduces power source impedance and stabilizes the input current to improve the efficiency. Select a  $C_{IN}$  value depending on the impedance of the power source used. The capacitor value is  $10\mu\text{F}$  min.

Select a large output capacitor ( $C_{OUT}$ ) with small electric series resistance (ESR) for reducing ripple voltage. As indicated in the equation (16), if the capacitor value is increased, the ripple voltage can be reduced (see the next page). Its capacitor value is  $22\mu\text{F}$  min. A tantalum electrolytic capacitor or an organic semiconductor capacitor is recommended to be used because of their excellent low temperature and leakage current characteristics.



# INVERTING SWITCHING REGULATORS

## S-8437/8438 Series

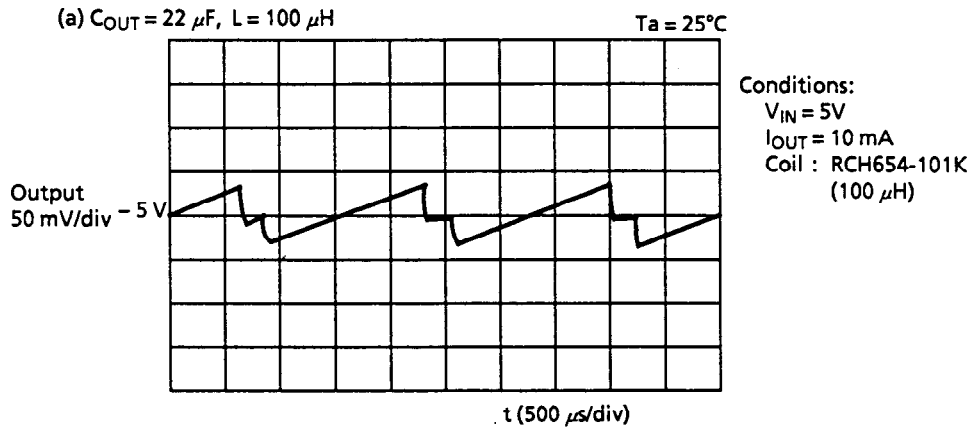

Figure 8

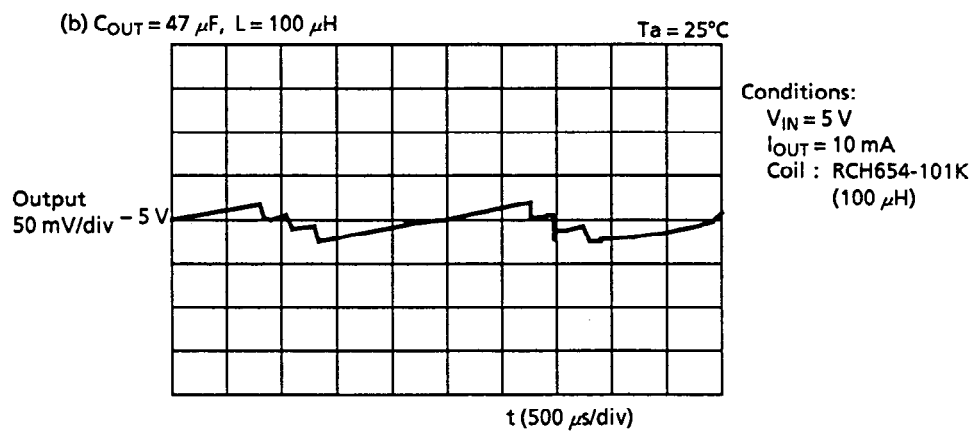

Figure 9

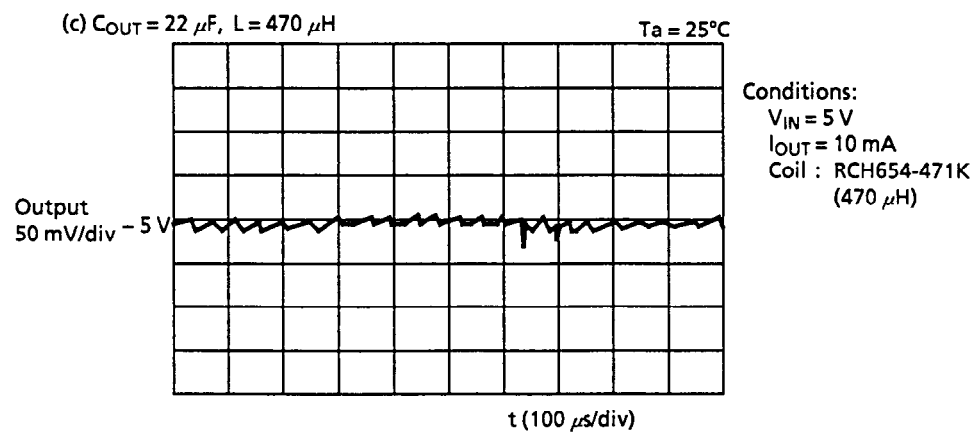

Figure 10

■ **Standard Circuits**

1. S-8437AF

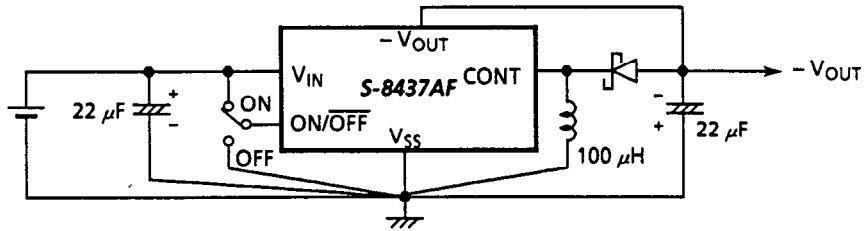
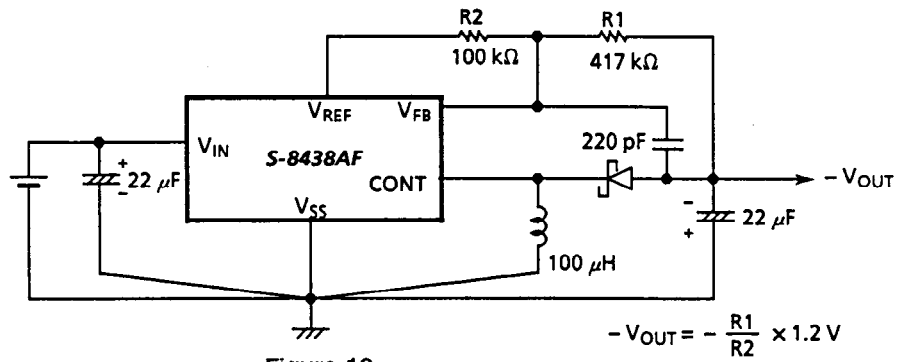

Figure 11

2. S-8438AF



$$-V_{OUT} = -\frac{R1}{R2} \times 1.2V$$

Figure 12

■ **Application Circuit**

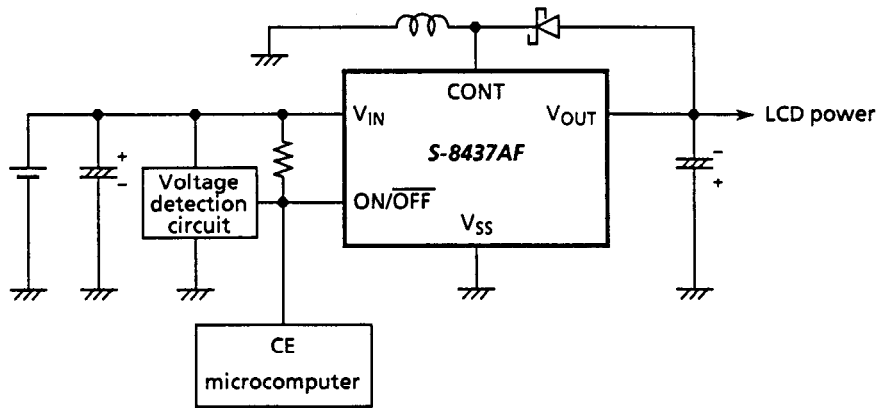

Figure 13 When the current consumption is decreased

# INVERTING SWITCHING REGULATORS

## S-8437/8438 Series

### Notes on Design

#### 1. Common for S-8437/8438AF

- Mount the external capacitor, diode, and coil as close to the ICs as possible to reduce the DC resistance.
- Take short-circuiting and overheating into consideration during design because no short-circuit or overheat protection circuits and loaded in the S-8437/8438AF. As reference, Figure 14 shows the package power dissipation when unmounting at an ambient temperature.

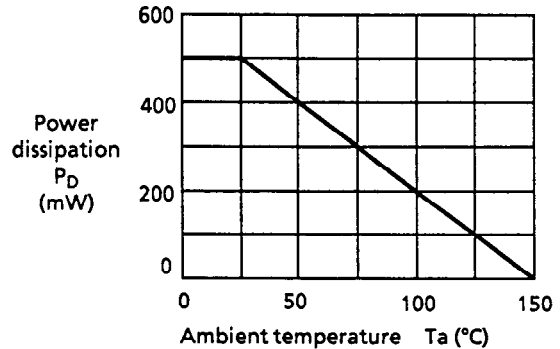

Figure 14 Package power dissipation (when not mounted)

#### 2. S-8437AF

- If the ON/OFF terminal is connected to the  $V_{IN}$  terminal, confirm that the fluctuation of the  $V_{IN}$  terminal voltage is higher than the  $V_{SL}$  level of the ON/OFF terminal. If the voltage fluctuation is lower than the  $V_{SL}$  level, the power is turned off and the output voltage is decreased. In this case, insert a filter circuit into the ON/OFF terminal, as shown in Figure 15.

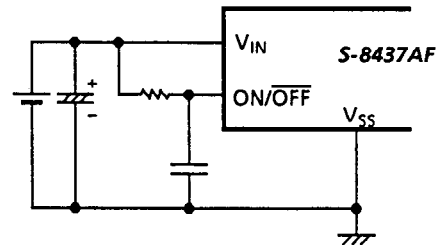

Figure 15

#### 3. S-8438AF

- If two external resistors are used, keep them as far away as possible from the coil and CONT terminal to prevent noise. In particular, if noise enters the  $V_{FB}$  terminal, the line regulation will deteriorate.
- Set the resistance values as follows:  
 $R_1$  : 2 M $\Omega$  or less  
 $R_2$  : 10 to 500 k $\Omega$
- The line regulation may be improved by adding the capacitor in parallel with the  $R_1$  resistor (in particular,  $I_{OUT} \geq 20$  mA application at  $V_{IN} \geq 7$  V). The capacitor value ( $C_C$ ) shall be  $R_1 \cdot C_C \approx 4 \mu s$ .

### Dimensions

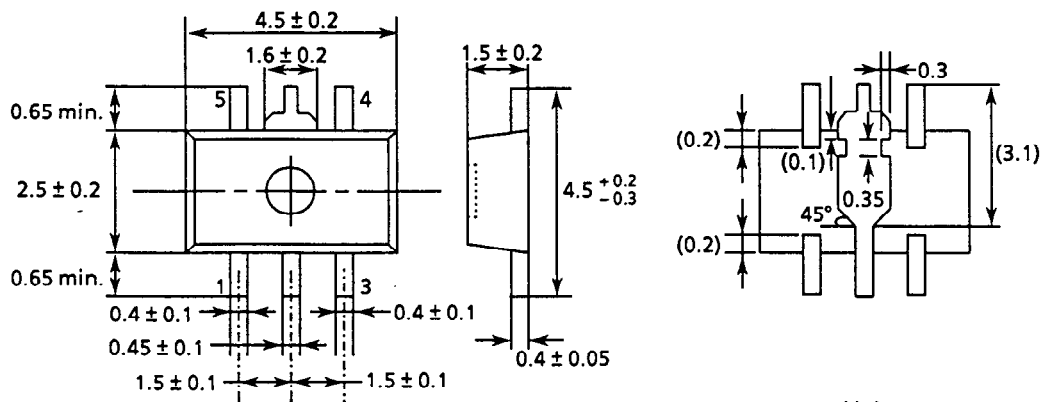
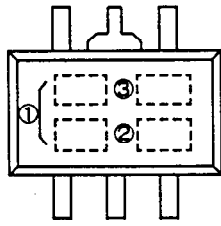

Figure 16

Unit : mm

■ Markings



- ① : Product name (abbreviation)
- ②, ③ : Month & week of assembly

Figure 17

# INVERTING SWITCHING REGULATORS S-8437/8438 Series

## ■ Taping

### 1. Tape Specifications

T1 and T2 types are available depending upon the direction of ICs on the tape.

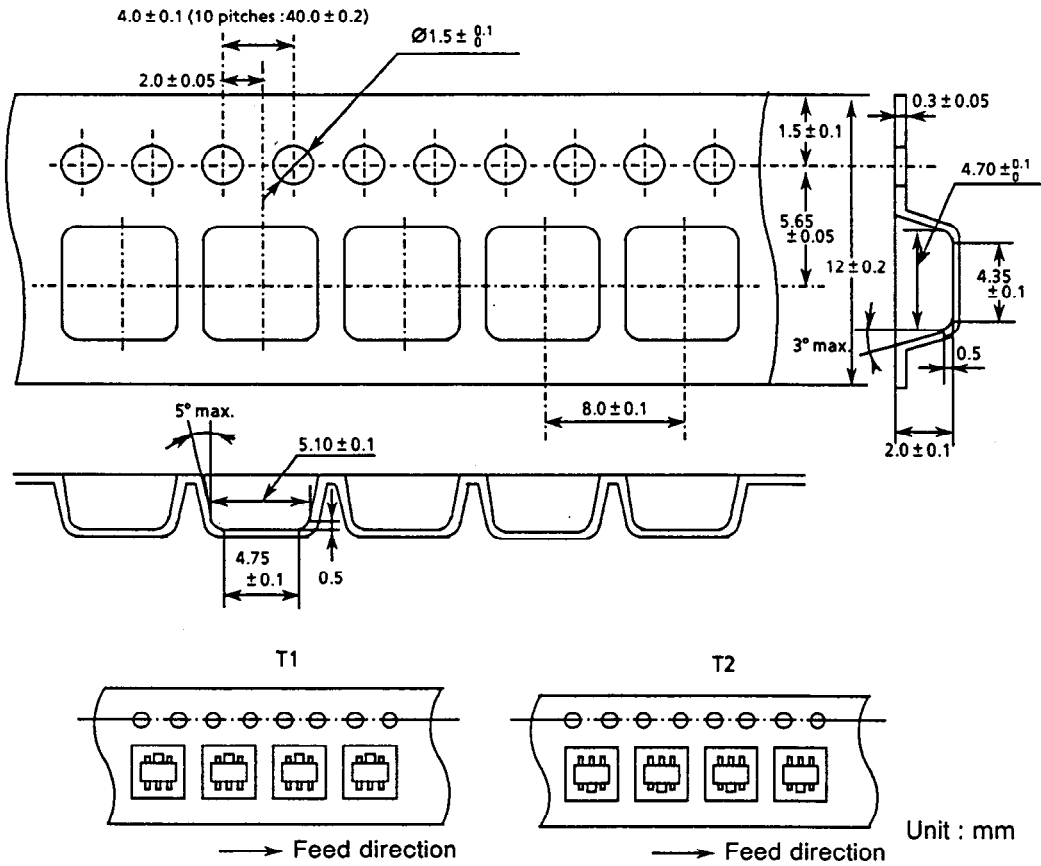

Figure 18

### 2. Reel specifications

1 reel holds 1000 regulators.

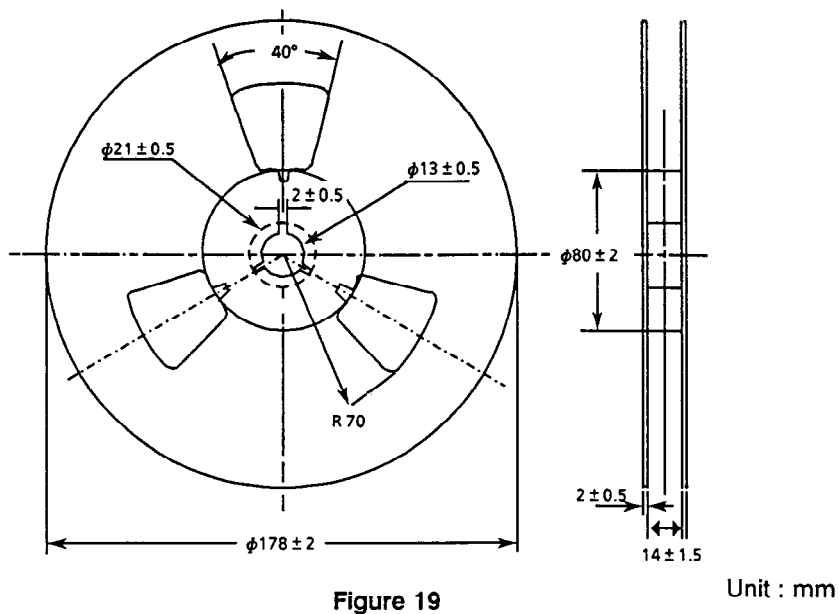
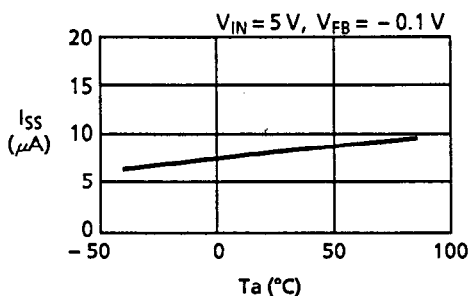

Figure 19

**■ Characteristics**

1. Operating current consumption ( $I_{SS}$ )  
- ambient temperature ( $T_a$ )



2. Shutdown terminal input voltage ( $V_{SH}, V_{SL}$ )  
- ambient temperature ( $T_a$ )

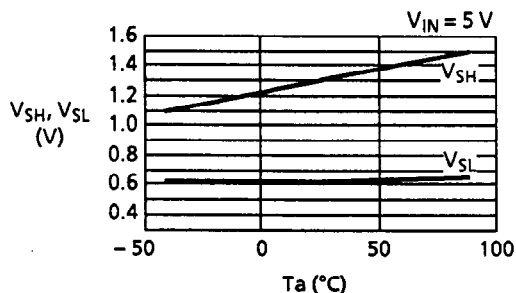

3. Shutdown terminal input voltage ( $V_{SH}, V_{SL}$ )  
- input voltage ( $V_{IN}$ )

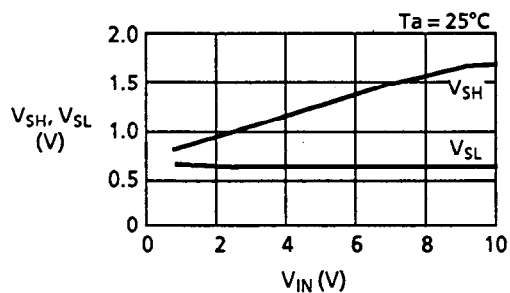

4. Oscillation frequency ( $f_{osc}$ )  
- ambient temperature ( $T_a$ )

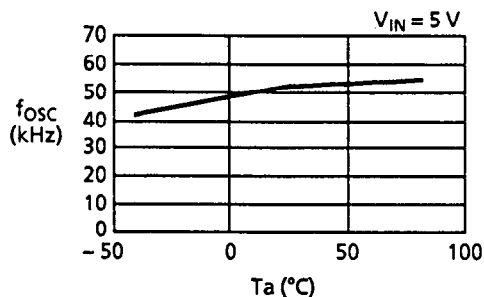

5. Oscillation frequency duty  
- ambient temperature ( $T_a$ )

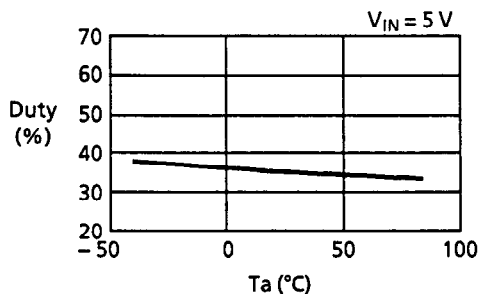

6. Oscillation frequency ( $f_{osc}$ )  
- input voltage ( $V_{IN}$ )

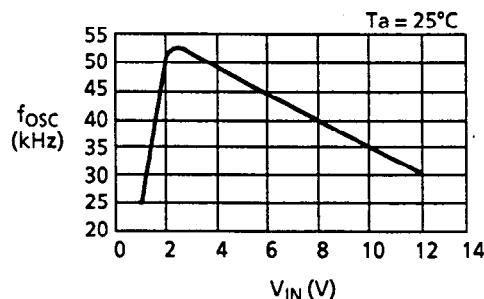

7. Oscillation frequency duty  
- input voltage ( $V_{IN}$ )

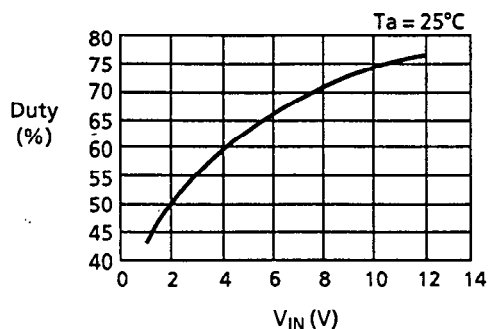

# INVERTING SWITCHING REGULATORS

## S-8437/8438 Series

8. Output voltage ( $-V_{OUT}$ )  
- output current ( $I_{OUT}$ )

Coil : RCH654-101K (100 $\mu$ H)  
(Sumida Electric)

(a)  $T_a = -40^\circ\text{C}$

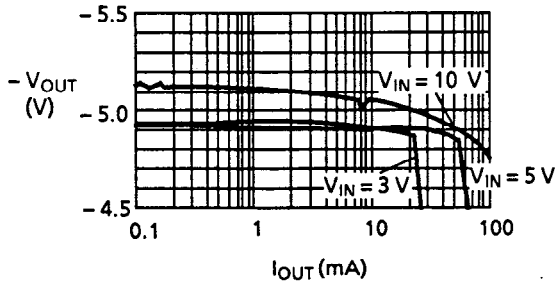

(b)  $T_a = 25^\circ\text{C}$

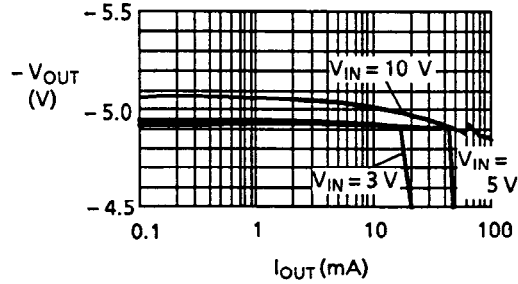

(c)  $T_a = 85^\circ\text{C}$

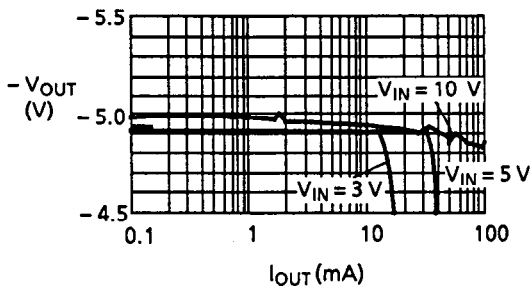

9. Maximum output current ( $I_{OUT(max)}$ )  
- ambient temperature ( $T_a$ )

Coil : RCH654  
(Sumida Electric)

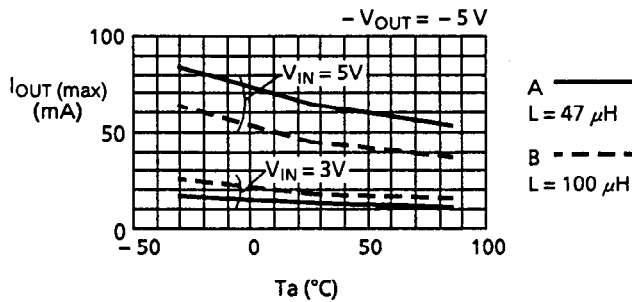

10. Maximum output current ( $I_{OUT(max)}$ )  
- output voltage ( $-V_{OUT}$ ) (S-8438 only)

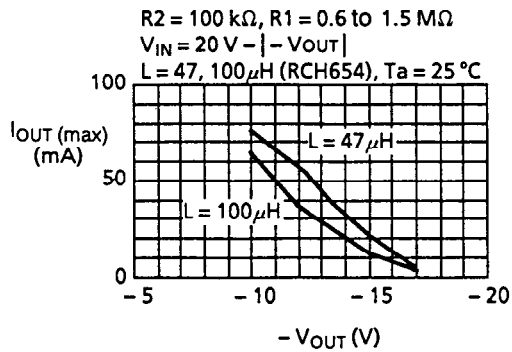

11. Temperature characteristics in 10

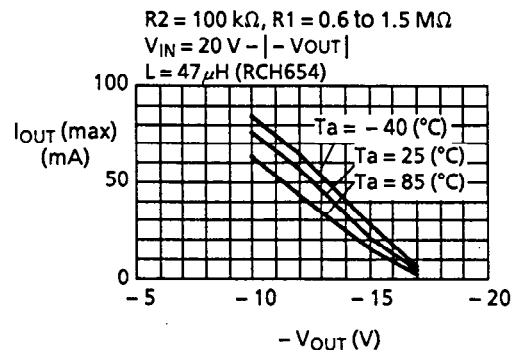

12. Maximum output current \* ( $I_{OUT(max)}$ )  
- inductor value (L) (S-8438AF)

12-1. Sumida Denki RCH654 series

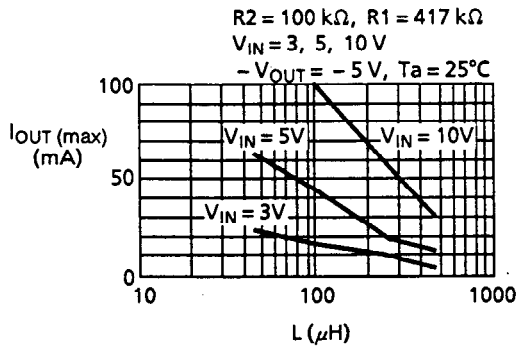

12-2. TDK chip coil NLC453232 series

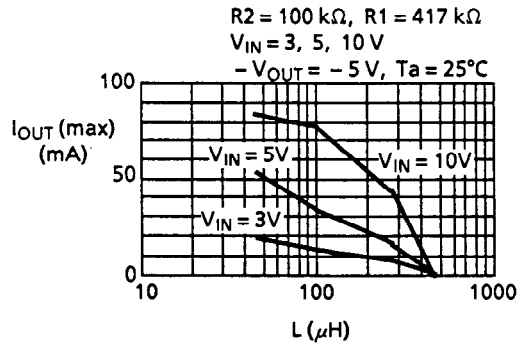

13. Transient response characteristics

13-1.  $V_{IN}$  step response characteristics  
( $V_{IN} = 0 \leftrightarrow 5\text{ V}$ )

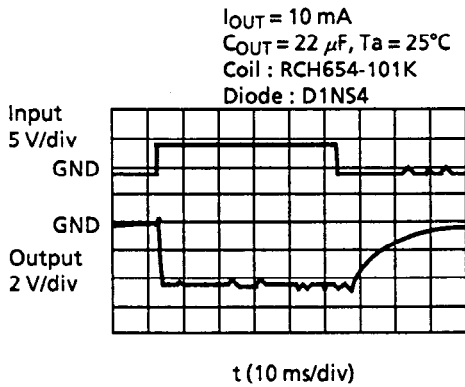

13-2.  $V_{IN}$  step response characteristics  
( $V_{IN} = 0 \leftrightarrow 10\text{ V}$ )

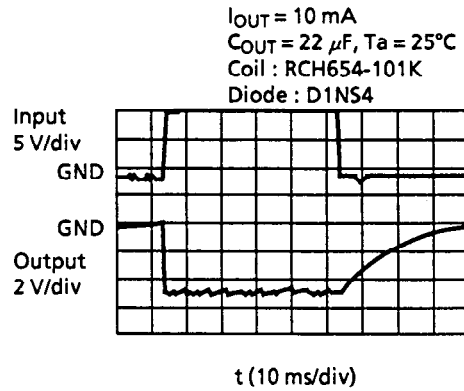

13-3. Shutdown terminal step response characteristics  
(ON/OFF =  $0 \leftrightarrow 5\text{ V}$ )

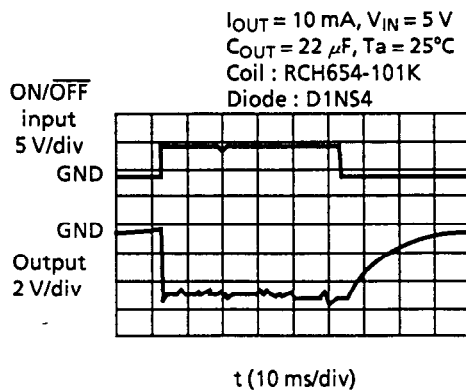

13-4. Load current fluctuation response characteristics  
( $I_{OUT} = 10\text{ }\mu\text{A} \leftrightarrow 15\text{ mA}$ )

