

DFN1006-2 / DFN1006H4-2 / MiniMELF / MELF / SOD-323 / SOD-123 / SOD-523 / SMA / SMB / SMC

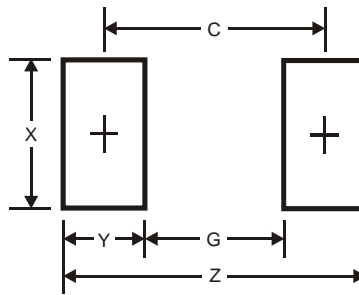

Dimensions	DFN1006-2 / DFN1006H4-2	MiniMELF	MELF	SOD-123	SOD-323	SOD-523	SMA	SMB	SMC
Z	1.1	4.7	6.3	4.9	3.75	2.3	6.5	6.8	9.4
G	0.3	2.1	3.3	2.5	1.05	1.1	1.5	1.8	4.4
X	0.7	1.7	2.7	0.7	0.65	0.8	1.7	2.3	3.3
Y	0.4	1.3	1.5	1.2	1.35	0.6	2.5	2.5	2.5
C	0.7	3.5	4.8	3.7	2.40	1.7	4.0	4.3	6.8

DFN1006-3 / DFN1006H4-3

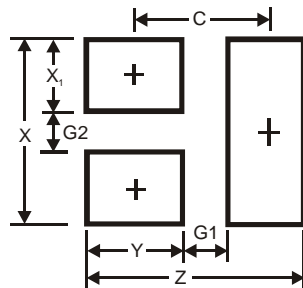

Dimensions	Value (in mm)
Z	1.1
G1	0.3
G2	0.2
X	0.7
X1	0.25
Y	0.4
C	0.7

DFN1411-3

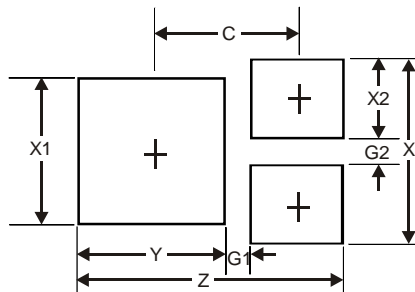

Dimensions	Value (in mm)
Z	1.38
G1	0.15
G2	0.15
X	0.95
X1	0.75
X2	0.40
Y	0.75
C	0.76

ALL DIMENSIONS ARE NOMINAL VALUES SHOWN IN MILLIMETERS

Note: The suggested land pattern dimensions have been provided for reference only, as actual pad layouts may vary depending on application. These numbers may be modified based on user equipment capability or fabrication criteria. A more robust pattern may be desired for wave soldering and is calculated by adding 0.2 mm to the 'Z' dimension. For further information, please reference document IPC-7351A, Naming Convention for Standard SMT Land Patterns, and for International grid details, please see document IEC, Publication 97.

DFN1612-6 / DFN1310H4-6

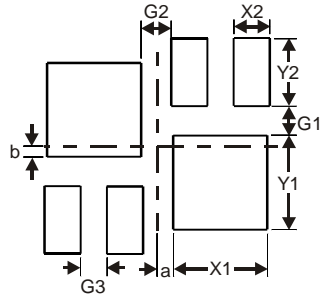

Dimensions	DFN1612-6	DFN1310H4-6
G1	0.15	0.16
G2	0.175	0.17
G3	0.15	0.15
X1	0.60	0.52
X2	0.25	0.20
Y1	0.65	0.52
Y2	0.45	0.375
a	0.10	0.09
b	0.15	0.06

DFN1616-6

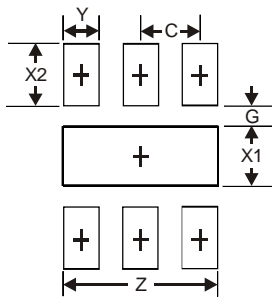

Dimensions	Value (in mm)
Z	1.3
G	0.175
X1	0.50
X2	0.525
Y	0.30
C	0.50

DFN1616-8

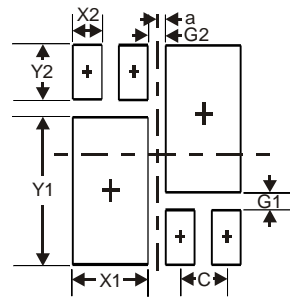

Dimensions	Value (in mm)
G1	0.15
G2	0.20
X1	0.65
X2	0.25
Y1	1.25
Y2	0.50
C	0.40
a	0.10

DFN2018-6

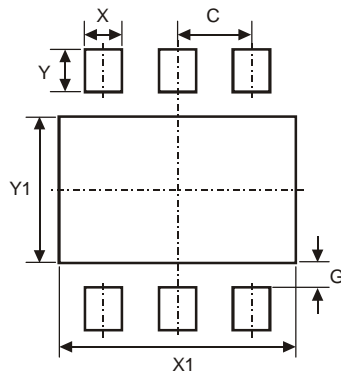

Dimensions	Value (in mm)
C	0.50
G	0.20
X	0.25
X1	1.60
Y	0.35
Y1	1.20

ALL DIMENSIONS ARE NOMINAL VALUES SHOWN IN MILLIMETERS

Note: The suggested land pattern dimensions have been provided for reference only, as actual pad layouts may vary depending on application. These numbers may be modified based on user equipment capability or fabrication criteria. A more robust pattern may be desired for wave soldering and is calculated by adding 0.2 mm to the 'Z' dimension. For further information, please reference document IPC-7351A, Naming Convention for Standard SMT Land Patterns, and for International grid details, please see document IEC, Publication 97.

DFN2020-3

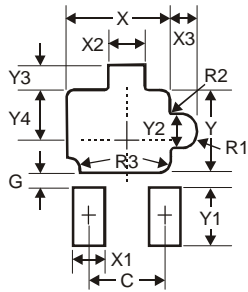

Dimensions	Value (in mm)
C	1.00
G	0.15
X	1.40
X1	0.35
X2	0.45
X3	0.322
Y	1.10
Y1	0.60
Y2	0.45
Y3	0.45
Y4	0.698
R1	0.225
R2	0.05
R3	0.20

DFN2020B-3

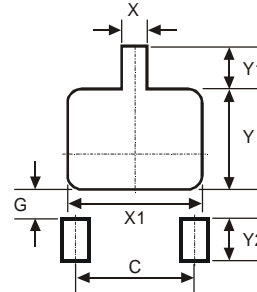

Dimensions	Value (in mm)
C	1.30
G	0.24
X	0.35
X1	1.52
Y	1.09
Y1	0.47
Y2	0.50

DFN2020-6

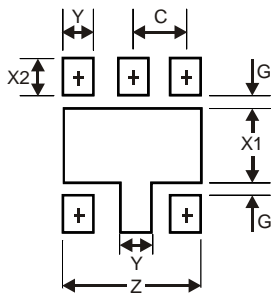

Dimensions	Value (in mm)
Z	1.67
G	0.15
X1	0.90
X2	0.45
Y	0.37
C	0.65

DFN2020B-6

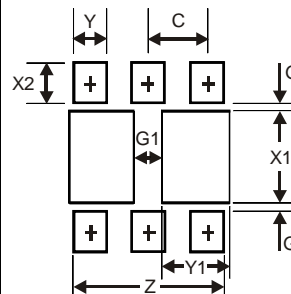

Dimensions	Value (in mm)
Z	1.67
G	0.20
G1	0.40
X1	1.0
X2	0.45
Y	0.37
Y1	0.70
C	0.65

DFN3020B-8

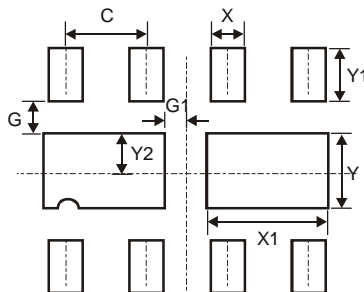

Dimensions	Value (in mm)
C	0.650
G	0.285
G1	0.090
X	0.400
X1	1.120
Y	0.730
Y1	0.500
Y2	0.365

ALL DIMENSIONS ARE NOMINAL VALUES SHOWN IN MILLIMETERS

Note: The suggested land pattern dimensions have been provided for reference only, as actual pad layouts may vary depending on application. These numbers may be modified based on user equipment capability or fabrication criteria. A more robust pattern may be desired for wave soldering and is calculated by adding 0.2 mm to the 'Z' dimension. For further information, please reference document IPC-7351A, Naming Convention for Standard SMT Land Patterns, and for International grid details, please see document IEC, Publication 97.

DFN3030-4

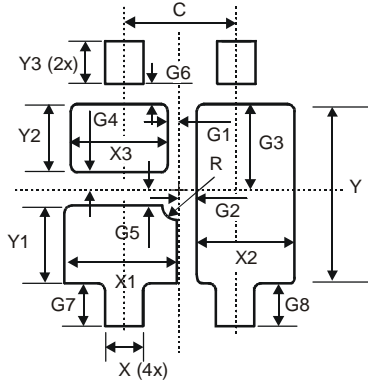

Dimensions	Value (in mm)
C	1.300
G1	0.100
G2	0.150
G3	0.830
G4	0.115
G5	0.135
G6	0.170
G7	0.500
G8	0.500
R	0.150
X	0.500
X1	1.375
X2	1.225
X3	1.175
Y	1.980
Y1	1.015
Y2	0.715
Y3	0.650

DFN3030-8

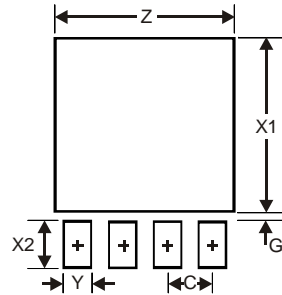

Dimensions	Value (in mm)
Z	2.59
G	0.11
X1	2.49
X2	0.65
Y	0.39
C	0.65

DFN3030E-8

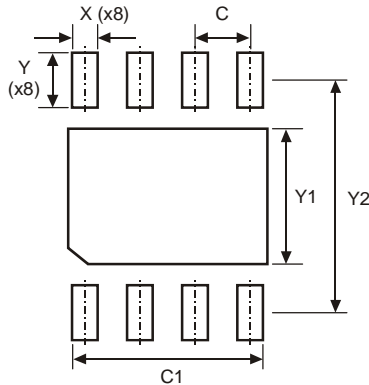

Dimensions	Value (in mm)
C	0.65
C1	2.35
X	0.30
Y	0.65
Y1	1.60
Y2	2.75

DFN3030-10

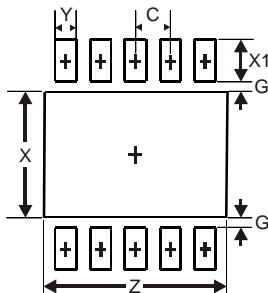

Dimensions	Value (in mm)
Z	2.60
G	0.15
X	1.80
X1	0.60
Y	0.30
C	0.50

DFN3030-12

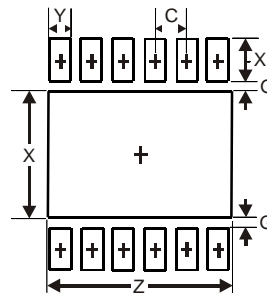

Dimensions	Value (in mm)
Z	2.60
G	0.15
X	1.80
X1	0.60
Y	0.28
C	0.45

ALL DIMENSIONS ARE NOMINAL VALUES SHOWN IN MILLIMETERS

Note: The suggested land pattern dimensions have been provided for reference only, as actual pad layouts may vary depending on application. These numbers may be modified based on user equipment capability or fabrication criteria. A more robust pattern may be desired for wave soldering and is calculated by adding 0.2 mm to the 'Z' dimension. For further information, please reference document IPC-7351A, Naming Convention for Standard SMT Land Patterns, and for International grid details, please see document IEC, Publication 97.

DFN5020-6

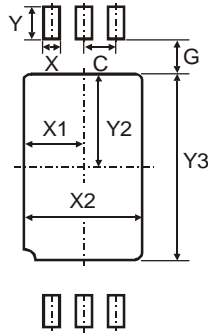

Dimensions	Value (in mm)
C	0.50
G	0.35
X	0.35
X1	0.90
X2	1.80
Y	0.70
Y2	1.60
Y3	3.20

DF-S / MiniDIP

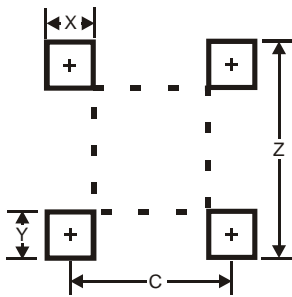

Dimensions	DF-S	MiniDIP
Z	10.26	6.91
X	1.2	0.60
Y	1.52	0.76
C	5.2	2.67

MSOP-8L

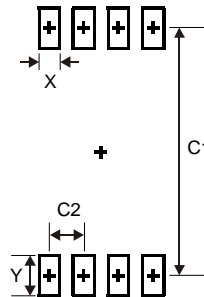

Dimensions	Value (in mm)
X	0.45
Y	1.4
C1	4.4
C2	0.65

MSOP-8L-EP

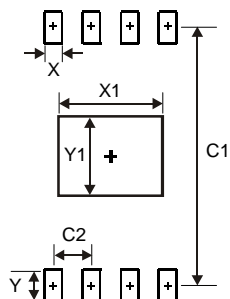

Dimensions	Value (in mm)
C1	4.2
C2	0.65
X	0.32
X1	1.95
Y	0.8
Y1	1.65

MSOP-10L

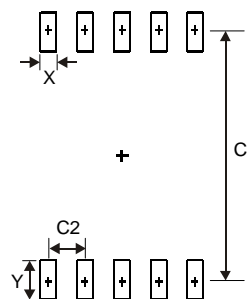

Dimensions	Value (in mm)
X	0.30
Y	1.4
C1	4.4
C2	0.50

ALL DIMENSIONS ARE NOMINAL VALUES SHOWN IN MILLIMETERS

Note: The suggested land pattern dimensions have been provided for reference only, as actual pad layouts may vary depending on application. These numbers may be modified based on user equipment capability or fabrication criteria. A more robust pattern may be desired for wave soldering and is calculated by adding 0.2 mm to the 'Z' dimension. For further information, please reference document IPC-7351A, Naming Convention for Standard SMT Land Patterns, and for International grid details, please see document IEC, Publication 97.

PowerDI®5

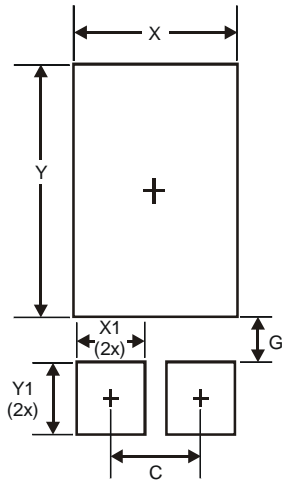

Dimensions	Value (in mm)
C	1.840
G	0.852
X	3.360
X1	1.390
Y	4.860
Y1	1.400

PowerDI®123 / PowerDI®323

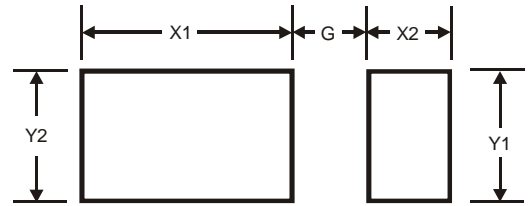

Dimensions	PowerDI®123	PowerDI®323
G	1.0	0.5
X1	2.2	2.0
X2	0.9	0.8
Y1	1.4	0.8
Y2	1.4	1.1

PowerDI3333-8

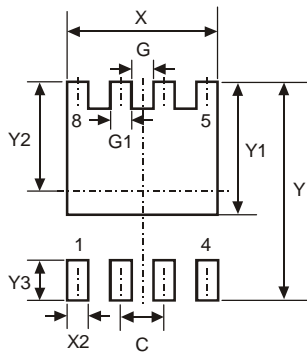

Dimensions	Value (in mm)
C	0.650
G	0.230
G1	0.420
Y	3.700
Y1	2.250
Y2	1.850
Y3	0.700
X	2.370
X2	0.420

PowerDI5060-8

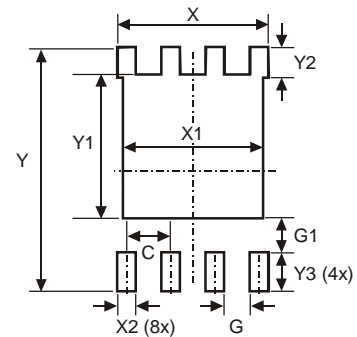

Dimensions	Value (in mm)
C	1.270
G	0.660
G1	0.820
X	4.420
X1	4.100
X2	0.610
Y	6.610
Y1	3.810
Y2	1.020
Y3	1.270

ALL DIMENSIONS ARE NOMINAL VALUES SHOWN IN MILLIMETERS

Note: The suggested land pattern dimensions have been provided for reference only, as actual pad layouts may vary depending on application. These numbers may be modified based on user equipment capability or fabrication criteria. A more robust pattern may be desired for wave soldering and is calculated by adding 0.2 mm to the 'Z' dimension. For further information, please reference document IPC-7351A, Naming Convention for Standard SMT Land Patterns, and for International grid details, please see document IEC, Publication 97.

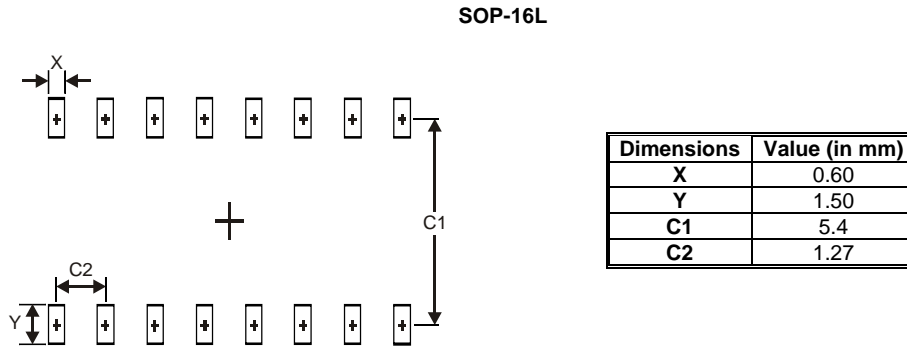
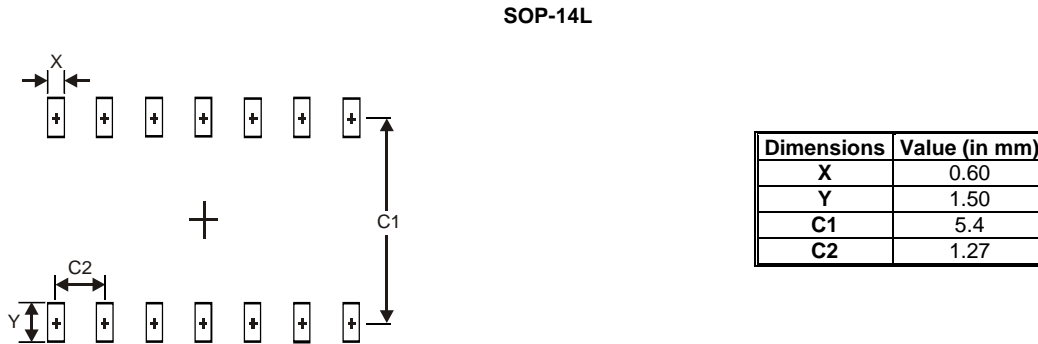
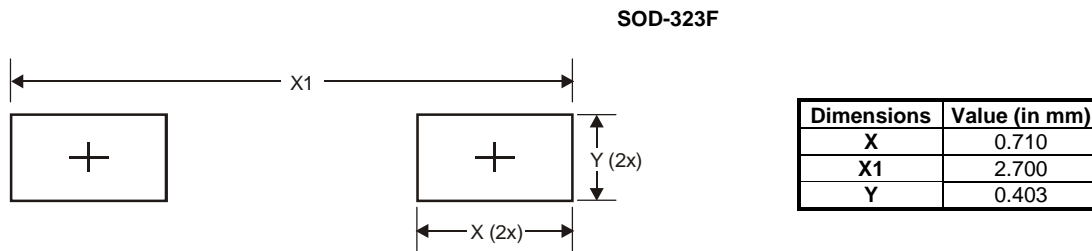
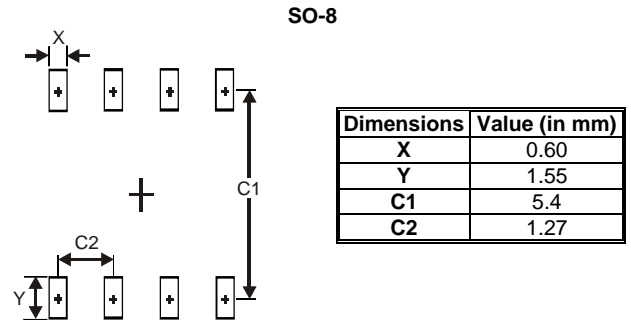
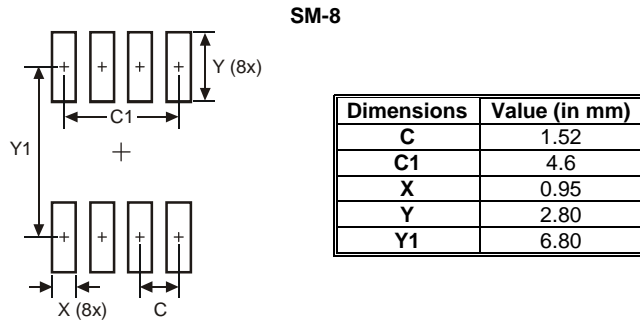

ALL DIMENSIONS ARE NOMINAL VALUES SHOWN IN MILLIMETERS

Note: The suggested land pattern dimensions have been provided for reference only, as actual pad layouts may vary depending on application. These numbers may be modified based on user equipment capability or fabrication criteria. A more robust pattern may be desired for wave soldering and is calculated by adding 0.2 mm to the 'Z' dimension. For further information, please reference document IPC-7351A, Naming Convention for Standard SMT Land Patterns, and for International grid details, please see document IEC, Publication 97.

SOT-143

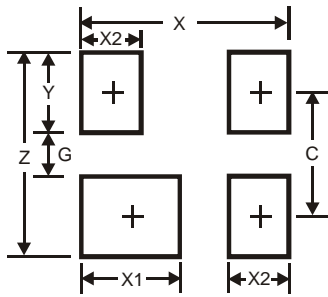

Dimensions	Value (in mm)
Z	2.70
G	1.30
X	2.50
X1	1.0
X2	0.60
Y	0.70
C	2.0

SOT-223

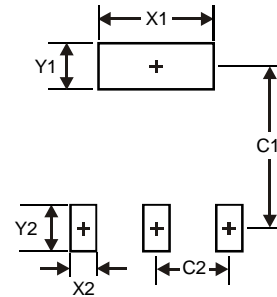

Dimensions	Value (in mm)
X1	3.3
X2	1.2
Y1	1.6
Y2	1.6
C1	6.4
C2	2.3

SOT-523 / SOT-323 / SOT23 / SC-59

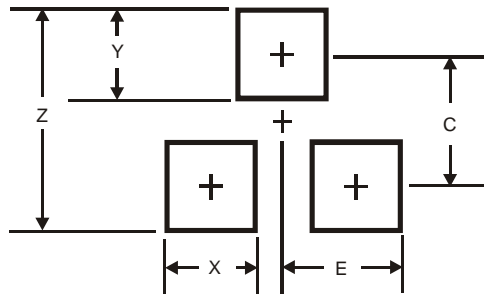

Dimensions	SOT-523	SOT-323	SOT23	SC-59
Z	1.8	2.8	2.9	3.4
X	0.4	0.7	0.8	0.8
Y	0.51	0.9	0.9	1.0
C	1.3	1.9	2.0	2.4
E	0.7	1.0	1.35	1.35

SOT-23F

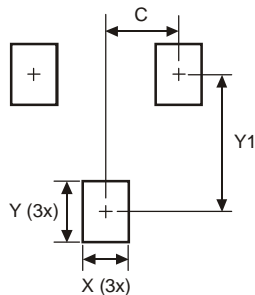

Dimensions	Value (in mm)
C	0.95
X	0.60
Y	0.80
Y1	1.80

ALL DIMENSIONS ARE NOMINAL VALUES SHOWN IN MILLIMETERS

Note: The suggested land pattern dimensions have been provided for reference only, as actual pad layouts may vary depending on application. These numbers may be modified based on user equipment capability or fabrication criteria. A more robust pattern may be desired for wave soldering and is calculated by adding 0.2 mm to the 'Z' dimension. For further information, please reference document IPC-7351A, Naming Convention for Standard SMT Land Patterns, and for International grid details, please see document IEC, Publication 97.

SC-74R / SOT-26 / SOT-363 / SOT-563

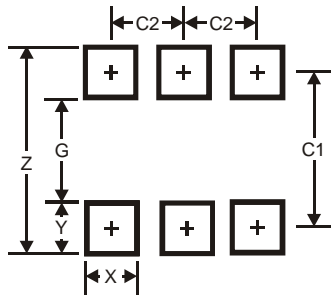

Dimensions	SC-74R / SOT-26	SOT-363	SOT-563
Z	3.20	2.5	2.2
G	1.60	1.3	1.2
X	0.55	0.42	0.375
Y	0.80	0.6	0.5
C1	2.40	1.9	1.7
C2	0.95	0.65	0.5

SOT-25 / SOT-353

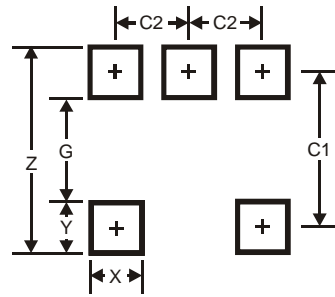

Dimensions	SOT-25	SOT-353
Z	3.20	2.5
G	1.60	1.3
X	0.55	0.42
Y	0.80	0.6
C1	2.40	1.9
C2	0.95	0.65

SOT-666

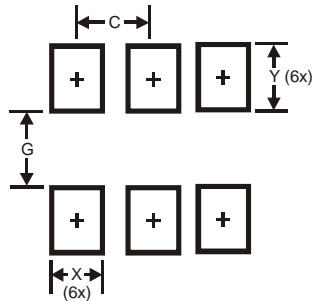

Dimensions	Value (in mm)
C	0.50
G	0.80
X	0.35
Y	0.50

SOT-953

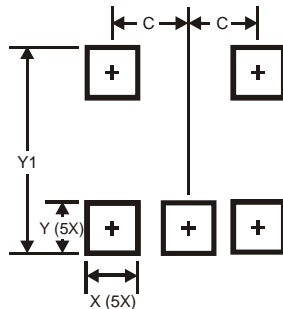

Dimensions	Value (in mm)
C	0.350
X	0.200
Y	0.200
Y1	1.100

ALL DIMENSIONS ARE NOMINAL VALUES SHOWN IN MILLIMETERS

Note: The suggested land pattern dimensions have been provided for reference only, as actual pad layouts may vary depending on application. These numbers may be modified based on user equipment capability or fabrication criteria. A more robust pattern may be desired for wave soldering and is calculated by adding 0.2 mm to the 'Z' dimension. For further information, please reference document IPC-7351A, Naming Convention for Standard SMT Land Patterns, and for International grid details, please see document IEC, Publication 97.

SOT-963

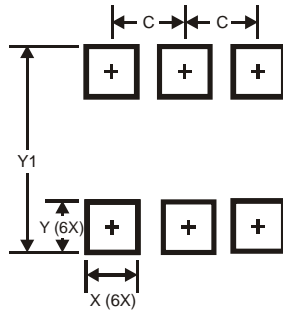

Dimensions	Value (in mm)
C	0.350
X	0.200
Y	0.200
Y1	1.100

SOT89-3L

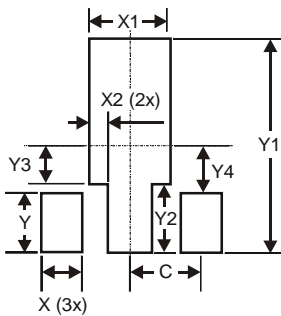

Dimensions	Value (in mm)
X	0.900
X1	1.733
X2	0.416
Y	1.300
Y1	4.600
Y2	1.475
Y3	0.950
Y4	1.125
C	1.500

SOT89-5L

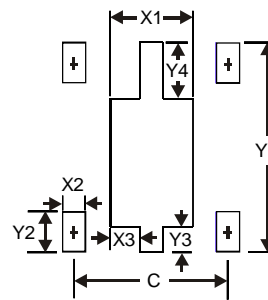

Dimensions	Value (in mm)
X1	1.7
X2	0.55
X3	0.4
Y1	4.6
Y2	1.2
Y3	0.5
Y4	1.1
C	3.0

TO252-3L (DPAK) / TO263-3L (D²PAK)

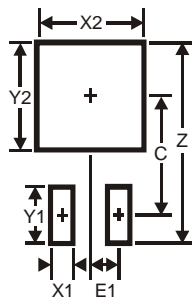

Dimensions	TO252-3L / DPAK	TO263-3L / D ² PAK
Z	11.6	16.9
X1	1.5	1.1
X2	7.0	10.8
Y1	2.5	3.5
Y2	7.0	11.4
C	6.9	9.5
E1	2.3	2.5

TO252-4L

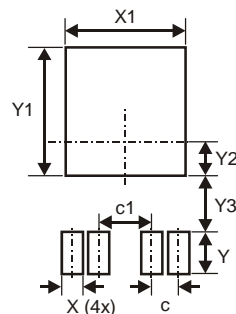

Dimensions	Value (in mm)
c	1.27
c1	2.54
X	1.00
X1	5.73
Y	2.00
Y1	6.17
Y2	1.64
Y3	2.66

ALL DIMENSIONS ARE NOMINAL VALUES SHOWN IN MILLIMETERS

Note: The suggested land pattern dimensions have been provided for reference only, as actual pad layouts may vary depending on application. These numbers may be modified based on user equipment capability or fabrication criteria. A more robust pattern may be desired for wave soldering and is calculated by adding 0.2 mm to the 'Z' dimension. For further information, please reference document IPC-7351A, Naming Convention for Standard SMT Land Patterns, and for International grid details, please see document IEC, Publication 97.

TO252-5L

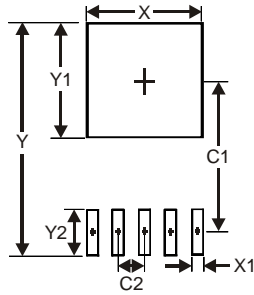

Dimensions	Value (in mm)
X	5.6
X1	0.6
Y	11.0
Y1	5.6
Y2	2.0
C1	7.2
C2	1.27

TO263-5L

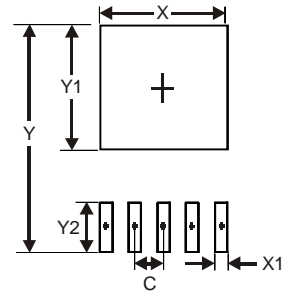

Dimensions	Value (in mm)
X	10.9
X1	1.05
Y	15.7
Y1	9.1
Y2	2.5
C	1.7

TSOT23-5

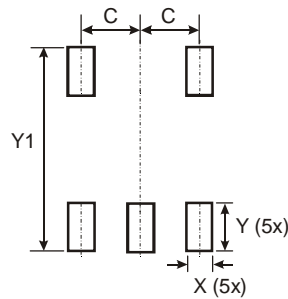

Dimensions	Value (in mm)
C	0.950
X	0.700
Y	1.000
Y1	3.199

TSOT23-6

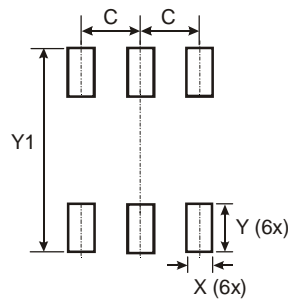

Dimensions	Value (in mm)
C	0.950
X	0.700
Y	1.000
Y1	3.199

ALL DIMENSIONS ARE NOMINAL VALUES SHOWN IN MILLIMETERS

Note: The suggested land pattern dimensions have been provided for reference only, as actual pad layouts may vary depending on application. These numbers may be modified based on user equipment capability or fabrication criteria. A more robust pattern may be desired for wave soldering and is calculated by adding 0.2 mm to the 'Z' dimension. For further information, please reference document IPC-7351A, Naming Convention for Standard SMT Land Patterns, and for International grid details, please see document IEC, Publication 97.

TSSOP-14L

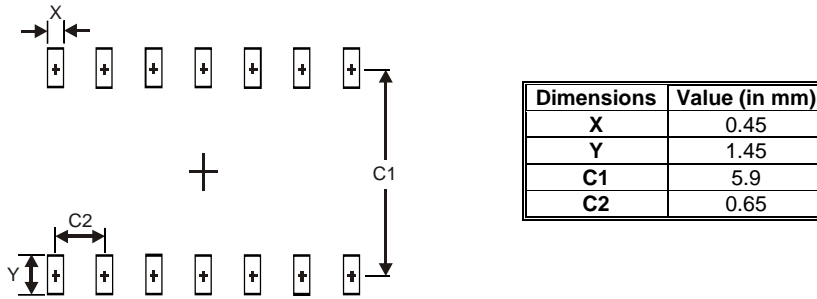

WL-CSD1010H6-4

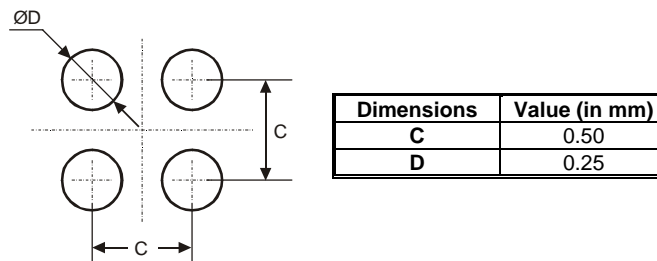

ALL DIMENSIONS ARE NOMINAL VALUES SHOWN IN MILLIMETERS

Note: The suggested land pattern dimensions have been provided for reference only, as actual pad layouts may vary depending on application. These numbers may be modified based on user equipment capability or fabrication criteria. A more robust pattern may be desired for wave soldering and is calculated by adding 0.2 mm to the 'Z' dimension. For further information, please reference document IPC-7351A, Naming Convention for Standard SMT Land Patterns, and for International grid details, please see document IEC, Publication 97.