



N-Channel Enhancement Mode Power MOSFET

# MTN10N60BE3

|  |       |
|--|-------|
| $BV_{DSS}$                             | 600V  |
| $I_D @ V_{GS}=10V, T_C=25^\circ C$     | 10A   |
| $R_{DS(on)(TYP)} @ V_{GS}=10V, I_D=6A$ | 0.59Ω |

## Description

The MTN10N60BE3 is a N-channel enhancement-mode MOSFET, providing the designer with the best combination of fast switching, ruggedized device design, low on-resistance and cost effectiveness. The TO-220 package is universally preferred for all commercial-industrial applications

## Features

- Low On Resistance
- Simple Drive Requirement
- Low Gate Charge
- Fast Switching Characteristic
- RoHS compliant package

## Applications

- Power Factor Correction
- LCD TV Power
- Full and Half Bridge Power

## Ordering Information

| Device             | Package                            | Shipping                                    |
|--------------------|------------------------------------|---|
| MTN10N60BE3-0-UB-X | TO-220<br>(RoHS compliant package) | 50 pcs/tube, 20 tubes/box, 4 boxes / carton |

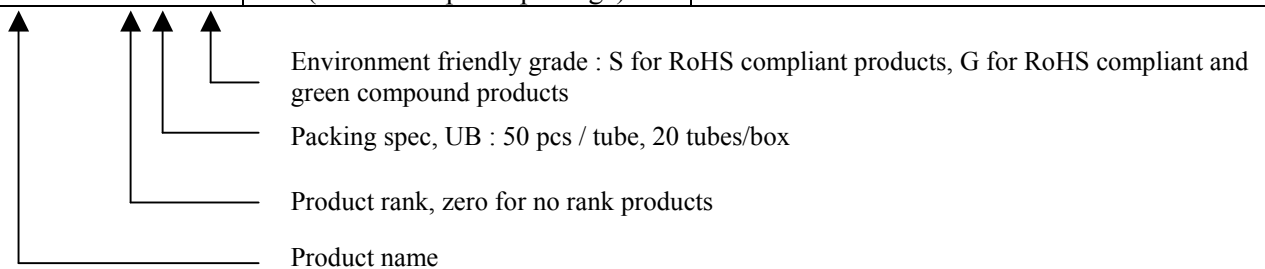

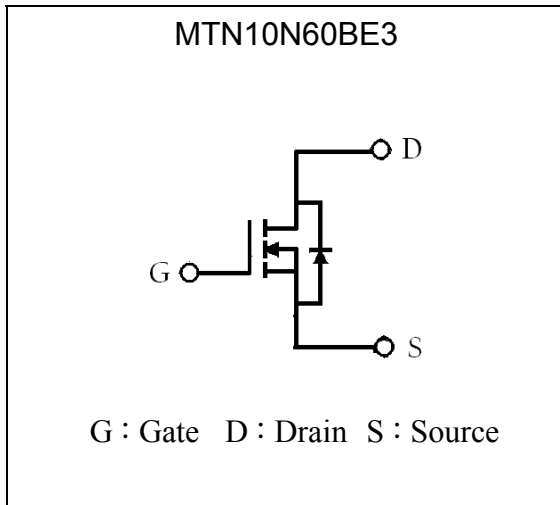
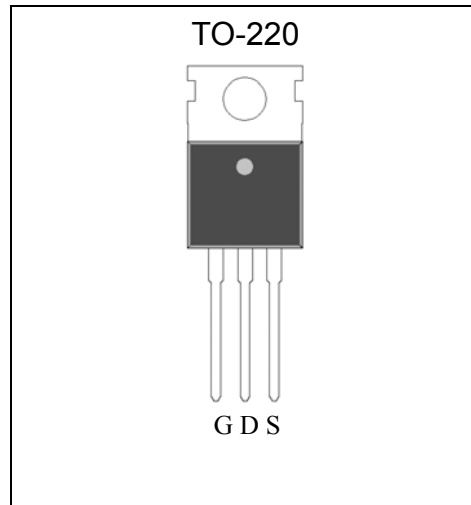
**Symbol**

**Outline**

**Absolute Maximum Ratings** (T<sub>c</sub>=25°C)

| Parameter   | Symbol                            | Limits   | Unit |
|---|-----------------------------------|----------|------|
| Drain-Source Voltage (Note 1)   | V <sub>DS</sub>                   | 600      | V    |
| Gate-Source Voltage   | V <sub>GS</sub>                   | ±30      |      |
| Continuous Drain Current @V <sub>GS</sub> =10V, T <sub>c</sub> =25°C                          | I <sub>D</sub>                    | 10       | A    |
| Continuous Drain Current @V <sub>GS</sub> =10V, T <sub>c</sub> =100°C                         |                                   | 6.3      |      |
| Pulsed Drain Current (Note 2)   | I <sub>DM</sub>                   | 40       |      |
| Single Pulse Avalanche Energy @ L=5mH, I <sub>D</sub> =10 Amps, V <sub>DD</sub> =50V (Note 3) | E <sub>AS</sub>                   | 250      | mJ   |
| Repetitive Avalanche Energy   | E <sub>AR</sub>                   | 5        |      |
| Maximum Temperature for Soldering @ Lead at 0.063 in(1.6mm) from case for 10 seconds          | T <sub>L</sub>                    | 300      | °C   |
| Maximum Temperature for Soldering @ Package Body for 10 seconds                               | T <sub>PKG</sub>                  | 260      |      |
| Total Power Dissipation (T <sub>c</sub> =25°C)  | P <sub>d</sub>                    | 185      | W    |
| Linear Derating Factor  |                                   | 1.48     | W/°C |
| Operating Junction and Storage Temperature  | T <sub>j</sub> , T <sub>stg</sub> | -55~+150 | °C   |

\*Drain current limited by maximum junction temperature

Note : 1. T<sub>J</sub>=+25°C to +150°C.

2. Repetitive rating; pulse width limited by maximum junction temperature.

3. 100% tested by conditions of L=5mH, I<sub>AS</sub>=5A, V<sub>GS</sub>=10V, V<sub>DD</sub>=50V



**Thermal Data**

| Parameter                                    | Symbol              | Value | Unit |
|--|---------------------|-------|------|
| Thermal Resistance, Junction-to-case, max    | R <sub>th,j-c</sub> | 0.68  | °C/W |
| Thermal Resistance, Junction-to-ambient, max | R <sub>th,j-a</sub> | 62.5  |      |

**Characteristics (T<sub>j</sub>=25°C, unless otherwise specified)**

| Symbol                              | Min. | Typ. | Max. | Unit | Test Conditions   |
|-------------------------------------|------|------|------|------|---|
| <b>Static</b>                       |      |      |      |      |   |
| BV <sub>DSS</sub>                   | 600  | -    | -    | V    | V <sub>GS</sub> =0V, I <sub>D</sub> =250μA  |
| ΔBV <sub>DSS</sub> /ΔT <sub>j</sub> | -    | 0.65 | -    | V/°C | Reference to 25°C, I <sub>D</sub> =250μA  |
| V <sub>GS(th)</sub>                 | 2.0  | -    | 4.0  | V    | V <sub>DS</sub> = V <sub>GS</sub> , I <sub>D</sub> =250μA                                 |
| *G <sub>FS</sub>                    | -    | 10.9 | -    | S    | V <sub>DS</sub> =15V, I <sub>D</sub> =5A  |
| I <sub>GSS</sub>                    | -    | -    | ±100 | nA   | V <sub>GS</sub> =±30V   |
| I <sub>DSS</sub>                    | -    | -    | 1    | μA   | V <sub>DS</sub> =600V, V <sub>GS</sub> =0V  |
| I <sub>DSS</sub>                    | -    | -    | 10   |      | V <sub>DS</sub> =480V, V <sub>GS</sub> =0V, T <sub>j</sub> =125°C                         |
| *R <sub>DS(ON)</sub>                | -    | 0.59 | 0.75 | Ω    | V <sub>GS</sub> =10V, I <sub>D</sub> =6A  |
| <b>Dynamic</b>                      |      |      |      |      |   |
| *Q <sub>g</sub>                     | -    | 43.4 | -    | nC   | I <sub>D</sub> =10A, V <sub>DD</sub> =300V, V <sub>GS</sub> =10V                          |
| *Q <sub>gs</sub>                    | -    | 8.5  | -    |      |   |
| *Q <sub>gd</sub>                    | -    | 18   | -    |      |   |
| *t <sub>d(ON)</sub>                 | -    | 19.4 | -    | ns   | V <sub>DD</sub> =300V, I <sub>D</sub> =10A, V <sub>GS</sub> =10V,<br>R <sub>G</sub> =9.1Ω |
| *t <sub>r</sub>                     | -    | 14.4 | -    |      |   |
| *t <sub>d(OFF)</sub>                | -    | 75.8 | -    |      |   |
| *t <sub>f</sub>                     | -    | 18   | -    |      |   |
| C <sub>iss</sub>                    | -    | 1599 | -    | pF   | V <sub>GS</sub> =0V, V <sub>DS</sub> =25V, f=1MHz   |
| C <sub>oss</sub>                    | -    | 159  | -    |      |   |
| C <sub>rss</sub>                    | -    | 26   | -    |      |   |
| <b>Source-Drain Diode</b>           |      |      |      |      |   |
| *V <sub>SD</sub>                    | -    | -    | 1.5  | V    | I <sub>S</sub> =10A, V <sub>GS</sub> =0V  |
| *I <sub>S</sub>                     | -    | -    | 10   | A    |   |
| *I <sub>SM</sub>                    | -    | -    | 40   |      |   |
| *t <sub>rr</sub>                    | -    | 424  | 636  | ns   | V <sub>GS</sub> =0V, I <sub>F</sub> =10A, dI <sub>F</sub> /dt=100A/μs                     |
| *Q <sub>rr</sub>                    | -    | 3.2  | 4.8  | μC   |   |

\*Pulse Test : Pulse Width ≤300μs, Duty Cycle≤2%

## Typical Characteristics

Typical Output Characteristics

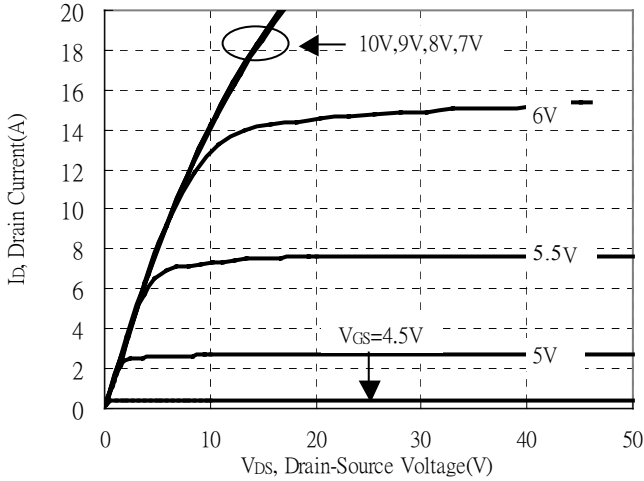

Static Drain-Source On-resistance vs Ambient Temperature

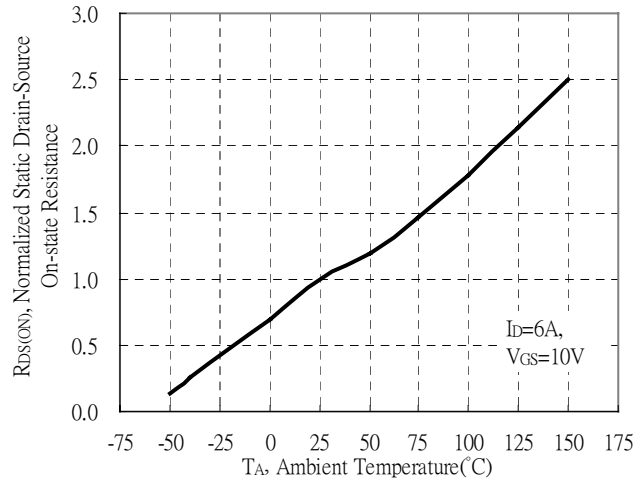

Static Drain-Source On-State resistance vs Drain Current

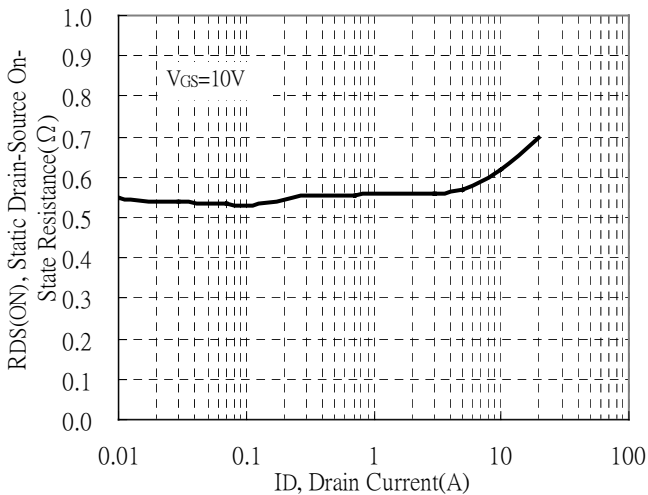

Drain Current vs Gate-Source Voltage

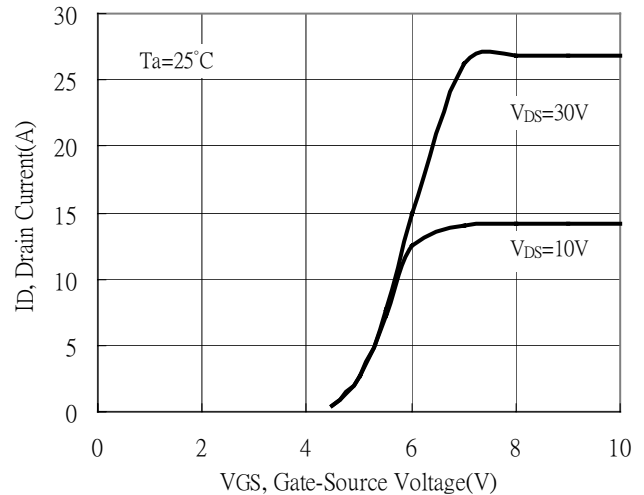

Static Drain-Source On-State Resistance vs Gate-Source Voltage

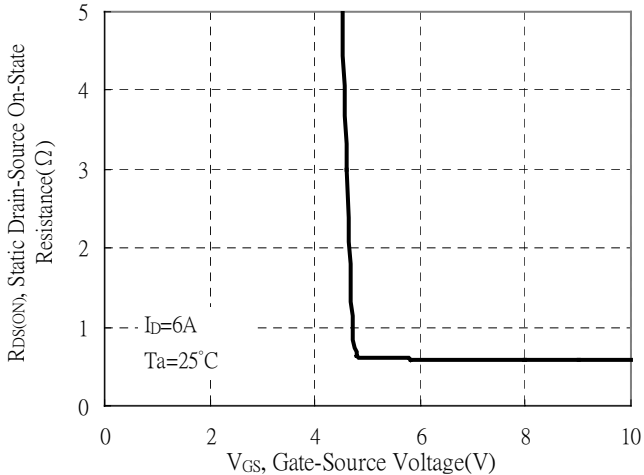

Forward Drain Current vs Source-Drain Voltage

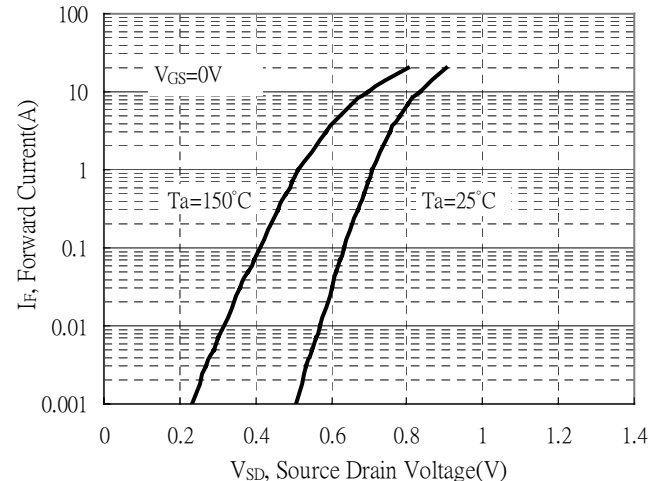

**Typical Characteristics(Cont.)**

Capacitance vs Reverse Voltage

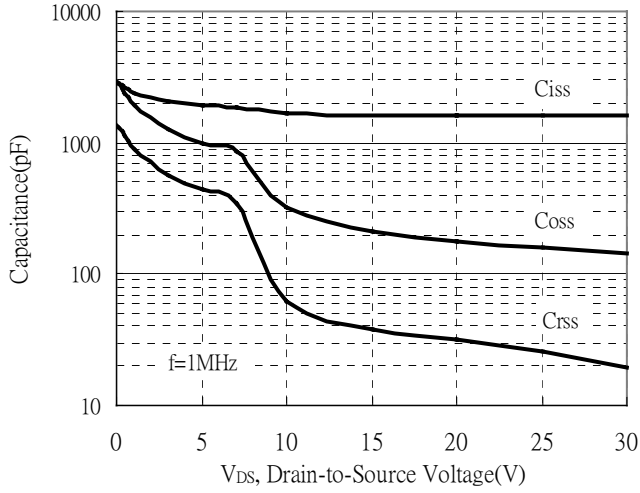

Brekdown Voltage vs Ambient Temperature

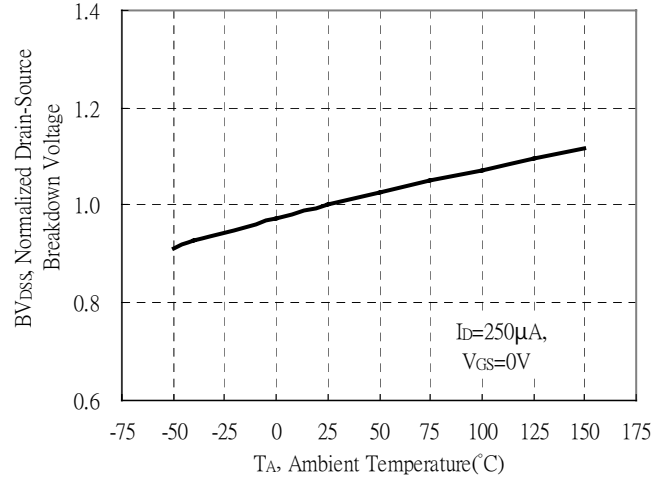

Maximum Safe Operating Area

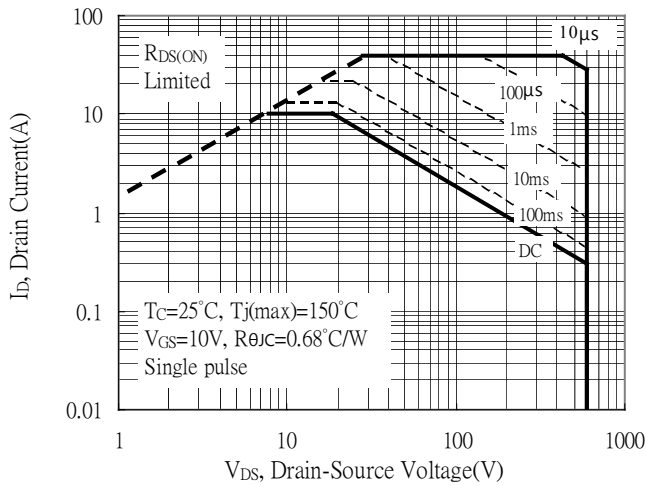

Gate Charge Characteristics

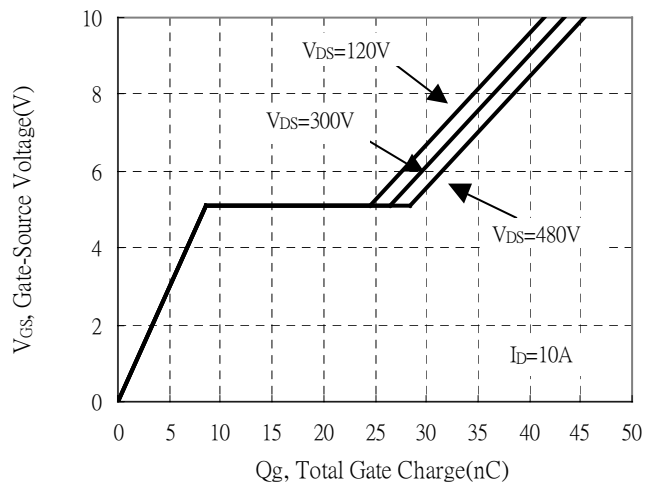

Maximum Drain Current vs Case Temperature

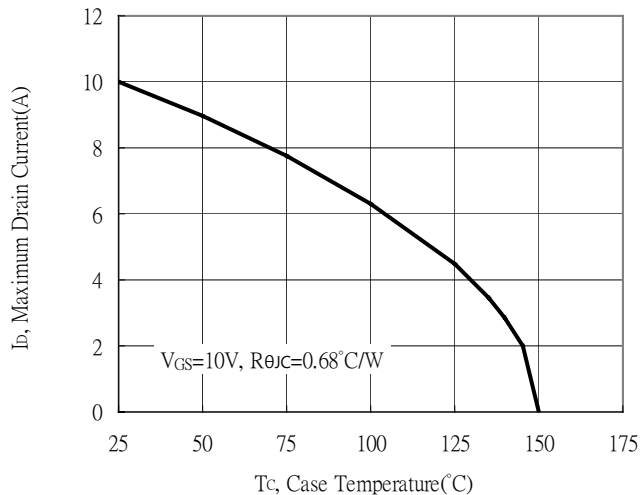

Threshold Voltage vs Junction Temperature

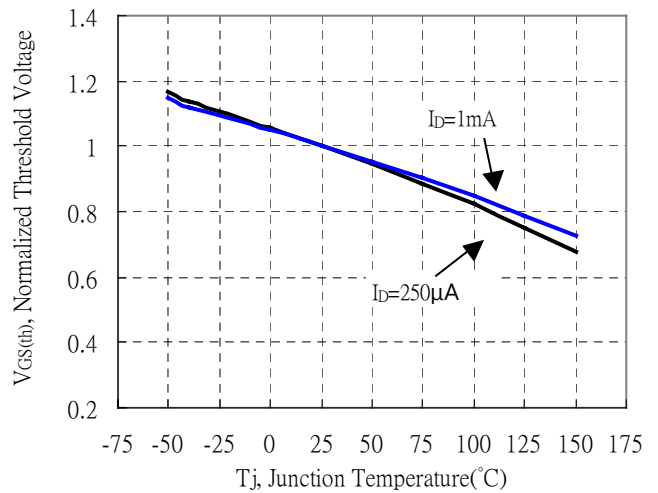



**Typical Characteristics(Cont.)**

Forward Transfer Admittance vs Drain Current

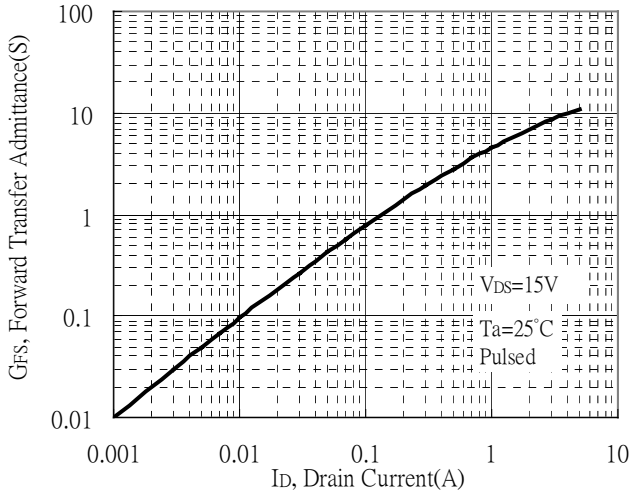

Single Pulse Power Rating, Junction to Case

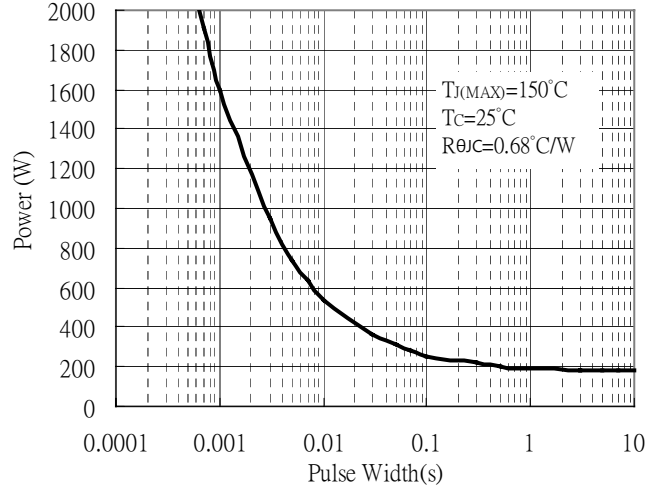

Transient Thermal Response Curves

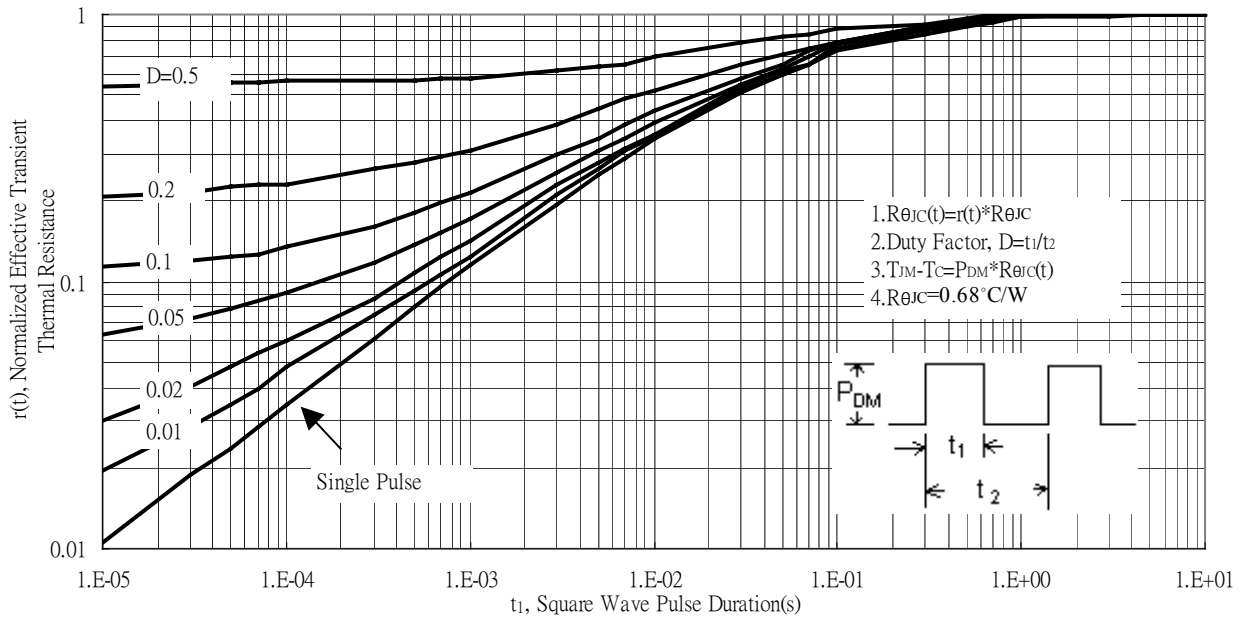

**Test Circuit and Waveforms**



**Gate Charge Test Circuit**

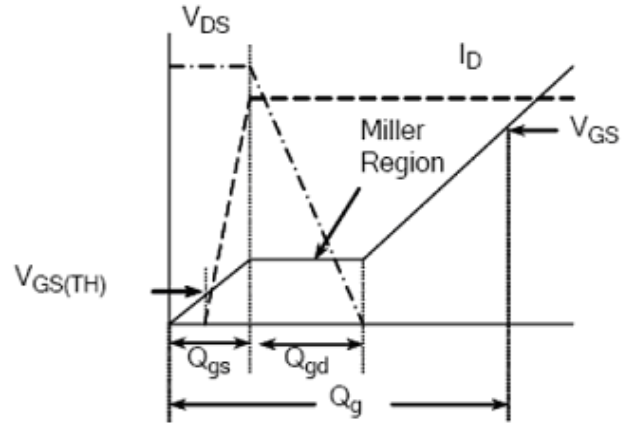

**Gate Charge Waveform**

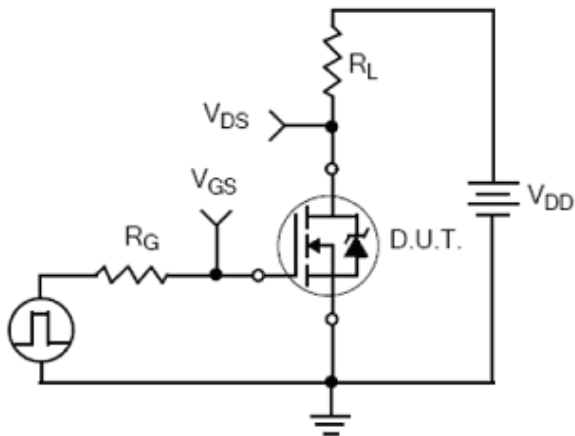

**Resistive Switching Test Circuit**



**Resistive Switching Waveforms**

**Test Circuit and Waveforms(Cont.)**



**Diode Reverse Recovery Test Circuit**

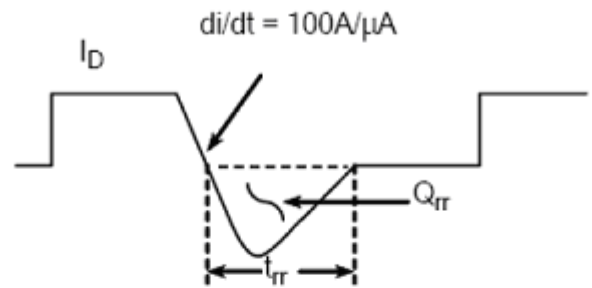

**Diode Reverse Recovery Waveform**

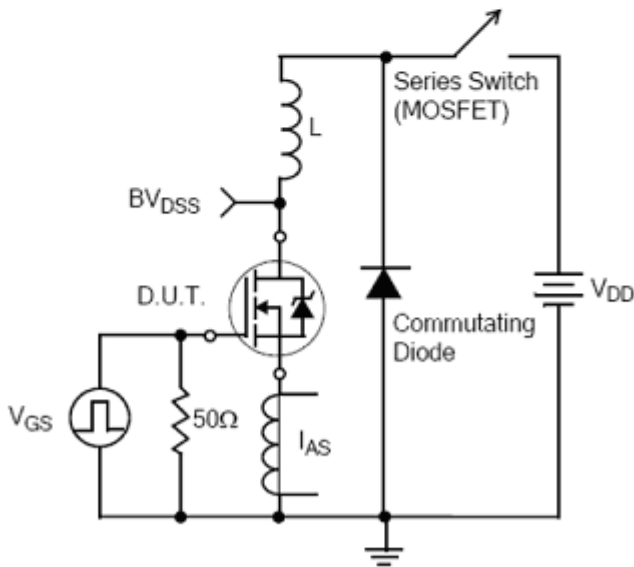

**Unclamped Inductive Switching Test Circuit**

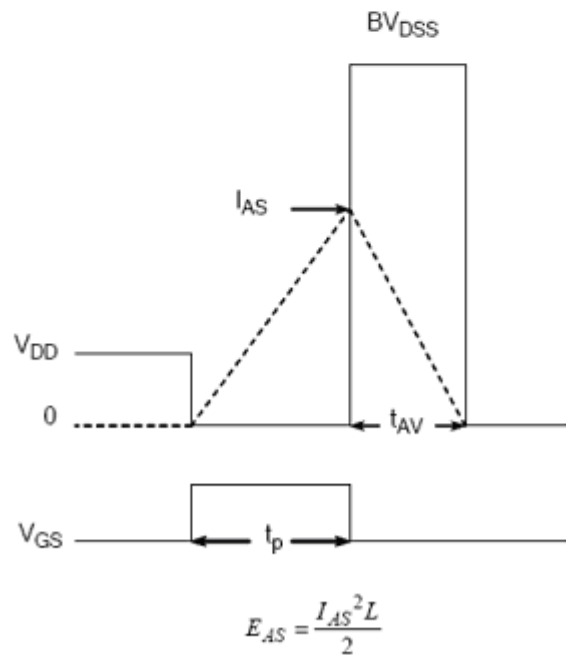

**Unclamped Inductive Switching Waveforms**



**Recommended wave soldering condition**

|                 |                  |                 |
|-----------------|------------------|-----------------|
| Product         | Peak Temperature | Soldering Time  |
| Pb-free devices | 260 +0/-5 °C     | 5 +1/-1 seconds |

**Recommended temperature profile for IR reflow**

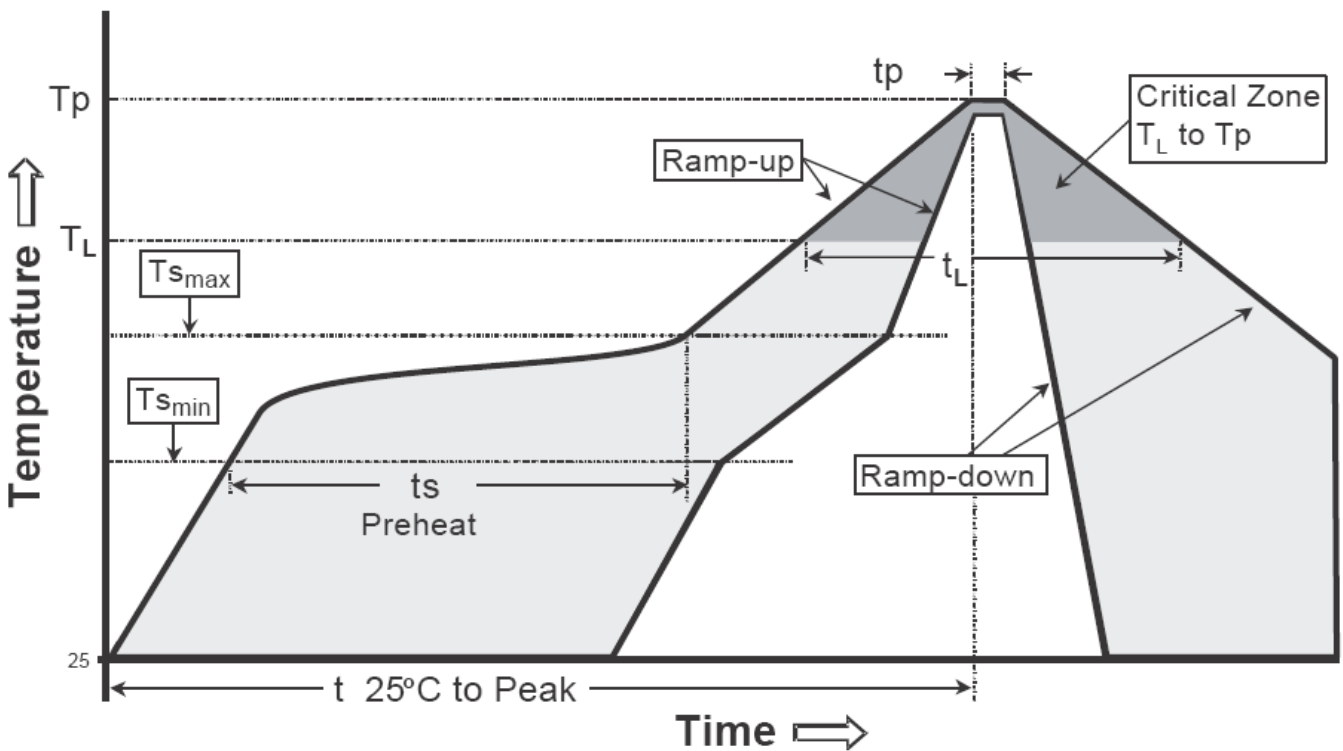

| Profile feature  | Sn-Pb eutectic Assembly | Pb-free Assembly |
|--|-------------------------|------------------|
| Average ramp-up rate (T <sub>s</sub> max to T <sub>p</sub> ) | 3°C/second max.         | 3°C/second max.  |
| Preheat  |                         |                  |
| -Temperature Min(T <sub>s</sub> min)                         | 100°C                   | 150°C            |
| -Temperature Max(T <sub>s</sub> max)                         | 150°C                   | 200°C            |
| -Time(t <sub>s</sub> min to t <sub>s</sub> max)              | 60-120 seconds          | 60-180 seconds   |
| Time maintained above:                                       |                         |                  |
| -Temperature (T <sub>L</sub> )                               | 183°C                   | 217°C            |
| - Time (t <sub>L</sub> )                                     | 60-150 seconds          | 60-150 seconds   |
| Peak Temperature(T <sub>P</sub> )                            | 240 +0/-5 °C            | 260 +0/-5 °C     |
| Time within 5°C of actual peak temperature(tp)               | 10-30 seconds           | 20-40 seconds    |
| Ramp down rate   | 6°C/second max.         | 6°C/second max.  |
| Time 25 °C to peak temperature                               | 6 minutes max.          | 8 minutes max.   |

Note : All temperatures refer to topside of the package, measured on the package body surface.

**TO-220 Dimension**

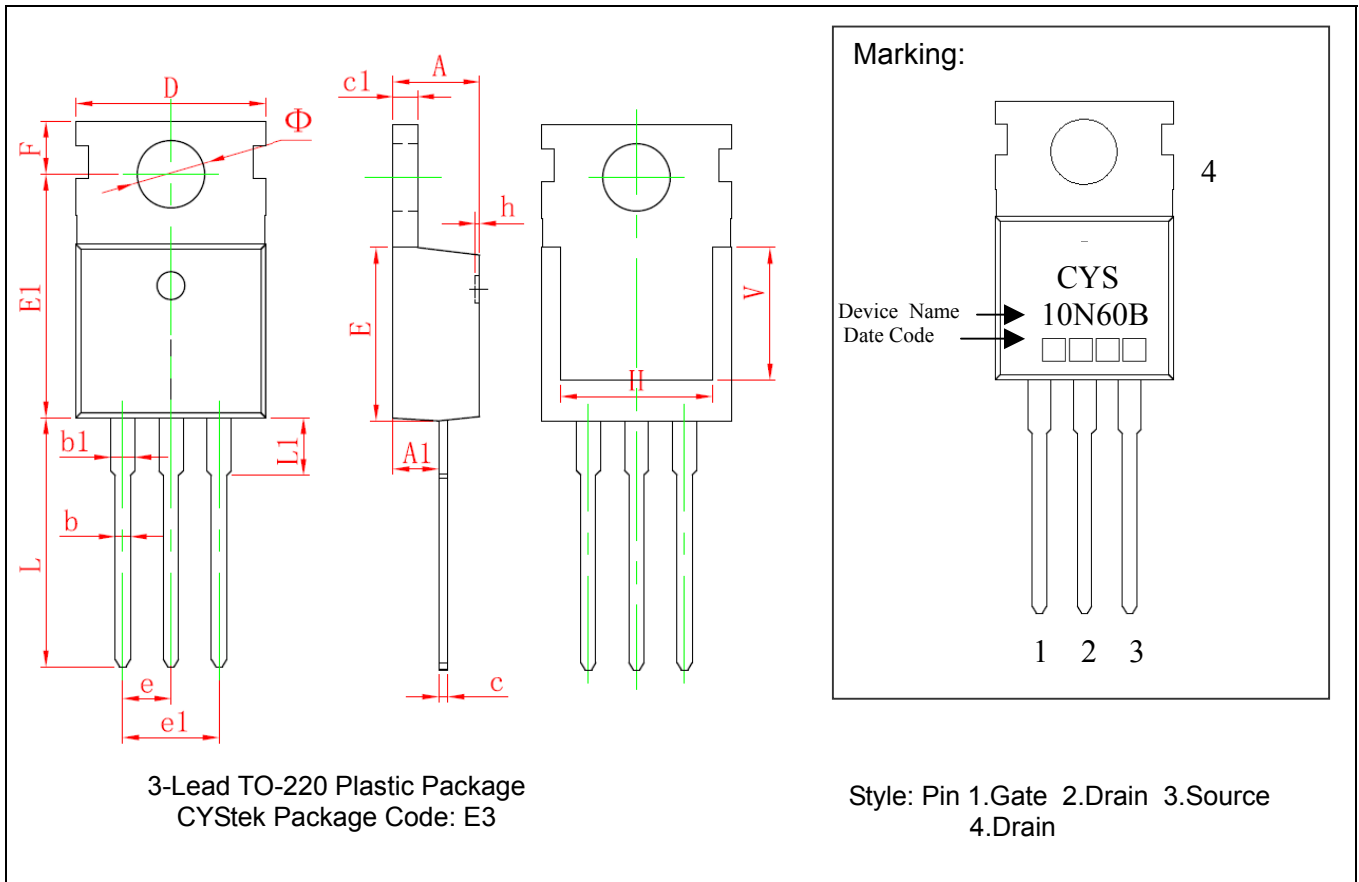

\*: Typical

| DIM | Millimeters |        | Inches |       | DIM | Millimeters |        | Inches |       |
|-----|-------------|--------|--------|-------|-----|-------------|--------|--------|-------|
|     | Min.        | Max.   | Min.   | Max.  |     | Min.        | Max.   | Min.   | Max.  |
| A   | 4.400       | 4.600  | 0.173  | 0.181 | e   | 2.540*      |        | 0.100* |       |
| A1  | 2.250       | 2.550  | 0.089  | 0.100 | e1  | 4.980       | 5.180  | 0.196  | 0.204 |
| b   | 0.710       | 0.910  | 0.028  | 0.036 | F   | 2.650       | 2.950  | 0.104  | 0.116 |
| b1  | 1.170       | 1.370  | 0.046  | 0.054 | H   | 7.900       | 8.100  | 0.311  | 0.319 |
| c   | 0.330       | 0.650  | 0.013  | 0.026 | h   | 0.000       | 0.300  | 0.000  | 0.012 |
| c1  | 1.200       | 1.400  | 0.047  | 0.055 | L   | 12.900      | 13.400 | 0.508  | 0.528 |
| D   | 9.910       | 10.250 | 0.390  | 0.404 | L1  | 2.850       | 3.250  | 0.112  | 0.128 |
| E   | 8.950       | 9.750  | 0.352  | 0.384 | V   | 7/500       | REF    | 0.295  | REF   |
| E1  | 12.650      | 12.950 | 0.498  | 0.510 | Φ   | 3.400       | 3.800  | 0.134  | 0.150 |

Notes: 1.Controlling dimension: millimeters.  
 2.Maximum lead thickness includes lead finish thickness, and minimum lead thickness is the minimum thickness of base material.  
 3.If there is any question with packing specification or packing method, please contact your local CYStek sales office.

**Material:**

- Lead: Pure tin plated.
- Mold Compound: Epoxy resin family, flammability solid burning class: UL94V-0.

**Important Notice:**

- All rights are reserved. Reproduction in whole or in part is prohibited without the prior written approval of CYStek.
- CYStek reserves the right to make changes to its products without notice.
- CYStek **semiconductor products are not warranted to be suitable for use in Life-Support Applications, or systems.**
- CYStek assumes no liability for any consequence of customer product design, infringement of patents, or application assistance.