

Reverse Bayonet Coupling Connectors

DCA-A-F Series

DDK Ltd.

RoHS Compliant

OUTLINE

DCA series is a bayonet coupling connector which utilizes MIL-DTL-5015 insert arrangements and is compatible with VG95234. The inserts are made of the thermosetting resin.

A various combination of the plugs, receptacles and accessories is also available and can be used for cable to cable usage and cable to panel usage.

The DCA series is suitable for applications such as servo motors, machine tools and factory automation equipment.



Conforming Standard
MIL-DTL-5015

Lock Type
Bayonet

FEATURES

- ◆ Quick positive bayonet coupling.
- ◆ Audible, tactile and visual indication of full coupling.
- ◆ Non-waterproof
- ◆ Wire connection : Soldering
- ◆ High shock and vibration capabilities.
- ◆ Operating temperature range: -55°C to 125°C
- ◆ Intermateable with existing VG95234 connectors.

SPECIFICATIONS

Contact Size	Rated current		Contact Resistance	
	Assembled in Insulator		Test Current	Voltage Descent
# 16	13A max.		13A	87mV max.
# 12	23A max.		23A	77mV max.
# 8	46A max.		46A	80mV max.
# 4	80A max.		80A	70mV max.
# 0	150A max.		150A	65mV max.

Service Rating	Rated voltage		Dielectric Withstand Voltage at 1 minute
	DC	AC(r.m.s.)	
INST	250V	200V	1,000V AC(r.m.s.)
A	700V	500V	2,000V AC(r.m.s.)
D	1,250V	900V	2,800V AC(r.m.s.)
E	1,750V	1,250V	3,500V AC(r.m.s.)

Insulation Resistance 5,000M Ω at 500VDC

Contact Size	Applicable Cable Size		
	A.W.G.	Official Sectional Area	Conductor Diameter
# 16	#16 ~ # 22	1.25mm ²	1.6mm Max.
# 12	#12 ~ #14	3.50mm ²	2.5mm Max.
# 8	#8 ~ #10	8.00mm ²	4.5mm Max.
# 4	#4 ~ #6	22.00mm ²	7.0mm Max.
# 0	#0 ~ #2	50.00mm ²	11.0mm Max.

MATERIAL / FINISH



Item	Material / Finish
Contact	Copper Alloy / Silver
Insert	Diallyl Phthalate Resin(Blue)
Shell	Aluminum Alloy / Zinc Plating, Black Cation Electroplating Finish
Retaining Ring	Copper Alloy / Nickel Plating
Gasket	Synthetic Rubber (Nitrile)

© Specifications and/or dimensions in this catalog are subject to change without notice.
Please verify the latest specifications with our drawings.

▶ Part Numbering System

(Part Numbering Example)

DCA 3106 A 20 - 29 S W - BSN - F (XXX)

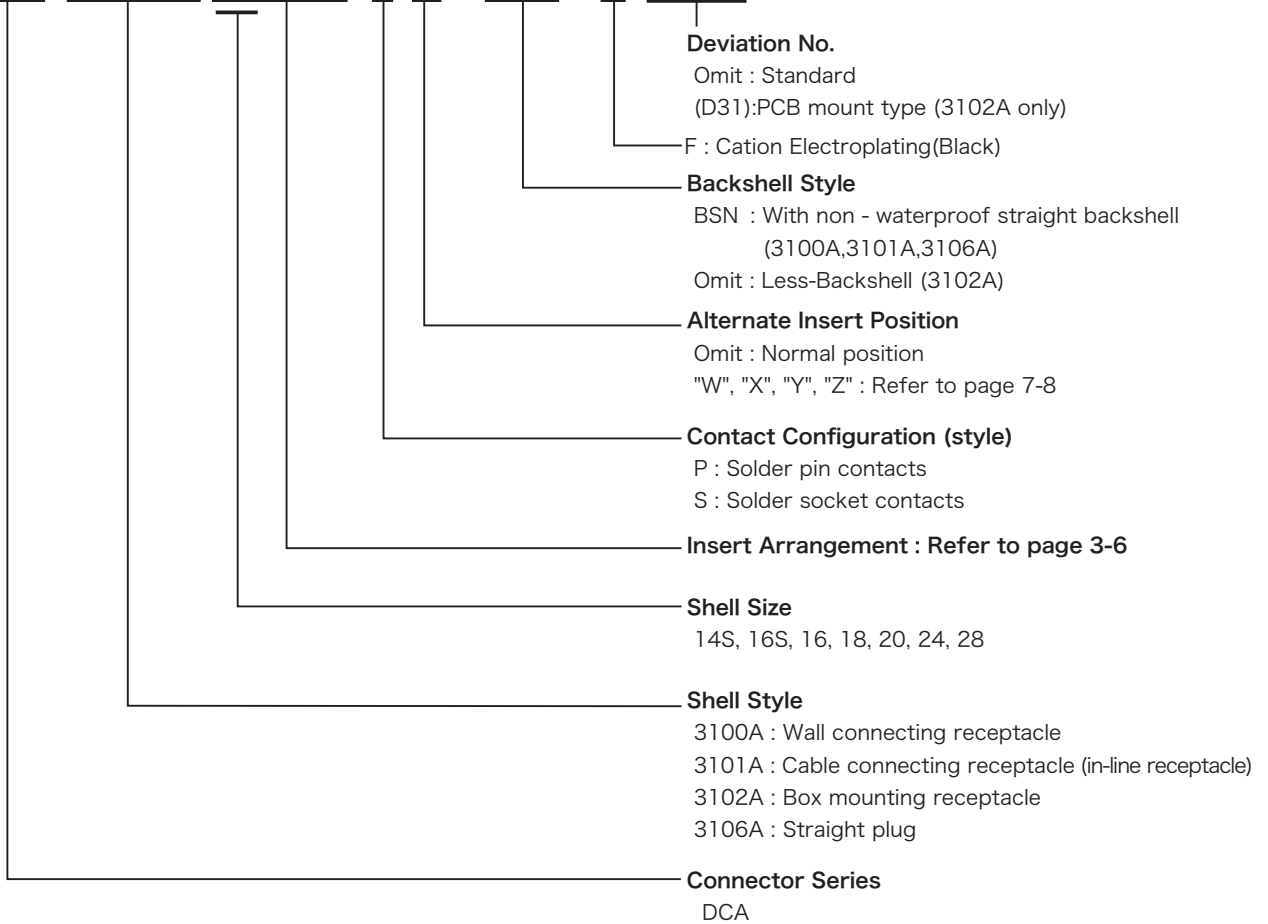

Connector Combination

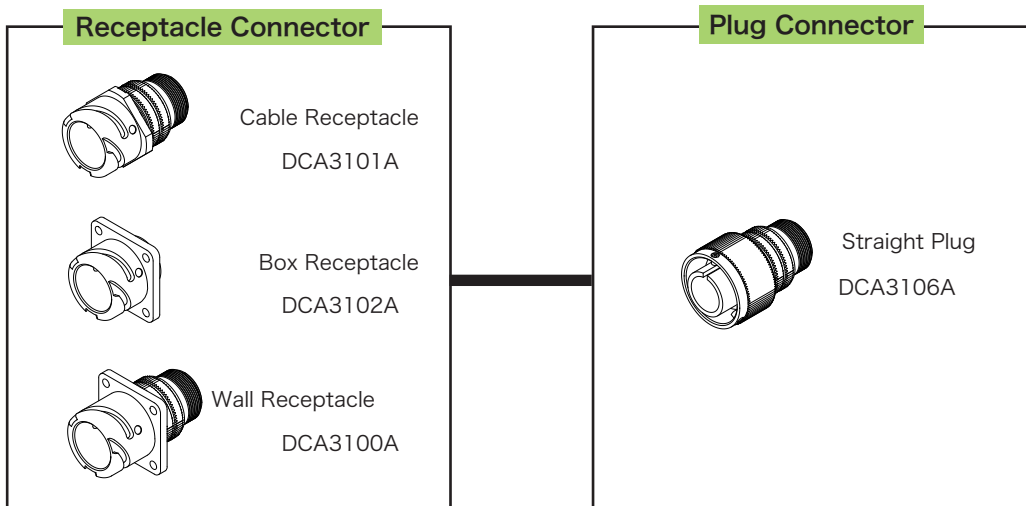

© Specifications and/or dimensions in this catalog are subject to change without notice.
Please verify the latest specifications with our drawings.

▶ Insert Arrangement List

Front View of Pin Contact

Number of Contact	1		2			
Insert Arrangement						
Insert Number	20-2	10SL-4	12S-3	14S-9	20-23	32-5
Contact Size	1-#0	2-#16	2-#16	2-#16	2-#8	2-#0
Service Rating	D	A	A	A	A	D
Rated Current	150A	13A	13A	13A	46A	150A

Number of Contact	3						
Insert Arrangement							
Insert Number	10SL-3	14S-1	14S-7	16S-5	16-10	18-5	18-21
Contact Size	3-#16	3-#16	3-#16	3-#16	3-#12	2-#12, 1-#16	3-#12
Service Rating	A	A	A	A	A	D	A
Rated Current	13A	13A	13A	13A	23A	#12 : 23A #16 : 13A	23A

Number of Contact	3			
Insert Arrangement				
Insert Number	18-22	22-2	28-6	36-4
Contact Size	3-#16	3-#8	3-#4	3-#0
Service Rating	D	D	D	D(A) A(BC)
Rated Current	13A	46A	80A	150A

Contact Size Symbol					
	#16	#12	#8	#4	#0
Service Rating	INST	A	D	E	
Rated Voltage AC(r.m.s.)	200	500	900	1,250	
Rated Voltage DC	250	700	1,200	1,750	
Contact Size	#16	#12	#8	#4	#0
MAX Current /Contact	13	23	46	80	150

© Specifications and/or dimensions in this catalog are subject to change without notice.
Please verify the latest specifications with our drawings.

▶ Insert Arrangement List

Number of Contact	4					
Insert Arrangement						
Insert Number	14S-2	18-4	18-10	20-4	22-10	22-22
Contact Size	4-#16	4-#16	4-#12	4-#12	4-#16	4-#8
Service Rating	INST	D	A	D	E	A
Rated Current	13A	13A	23A	23A	13A	46A

Number of Contact	4		
Insert Arrangement			
Insert Number	24-22	32-17	36-5
Contact Size	4-#8	4-#4	4-#0
Service Rating	D	D	A
Rated Current	46A	80A	150A

Number of Contact	5					
Insert Arrangement						
Insert Number	14S-5	16S-8	18-11	18-20	32-1	32-2
Contact Size	5-#16	5-#16	5-#12	5-#16	2-#0, 3-#12	3-#4, 2-#16
Service Rating	INST	A	A	A	E(A), D	E
Rated Current	13A	13A	23A	13A	#0 : 150A #12 : 23A	#4 : 80A #16 : 13A

Number of Contact	6				
Insert Arrangement					
Insert Number	14S-6	18-12	20-17	20-22	36-3
Contact Size	6-#16	6-#16	5-#12, 1-#16	3-#8, 3-#16	3-#0, 3-#12
Service Rating	INST	A	A	A	D
Rated Current	13A	13A	#12 : 23A #16 : 13A	#8 : 46A #16 : 13A	#0 : 150A #16 : 23A

Contact Size Symbol	●	⊕	⊗	⊙	⊕
	#16	#12	#8	#4	#0
Service Rating	INST	A	D	E	
Rated Voltage AC(r.m.s)	200	500	900	1,250	
Rated Voltage DC	250	700	1,200	1,750	
Contact Size	#16	#12	#8	#4	#0
MAX Current /Contact	13	23	46	80	150

© Specifications and/or dimensions in this catalog are subject to change without notice.
Please verify the latest specifications with our drawings.

▶ Insert Arrangement List

Number of Contact	7					
Insert Arrangement						
Insert Number	16S-1	20-15	22-28	24-2	24-10	28-10
Contact Size	7-#16	7-#12	7-#12	7-#12	7-#8	2-#4, 2-#8, 3-#12
Service Rating	A	A	A	D	A	D(G), A
Rated Current	13A	23A	23A	23A	46A	#4 : 80A #8 : 46A #12 : 23A

Number of Contact	8			9		
Insert Arrangement						
Insert Number	18-8	20-7	22-23	20-16	20-18	24-11
Contact Size	1-#12, 7-#16	8-#16	8-#12	2-#12, 7-#16	3-#12, 6-#16	3-#8, 6-#12
Service Rating	A	D(ABHG) A(CDEF)	D(H) A	A	A	A
Rated Current	#12 : 23A #16 : 13A	13A	23A	#12 : 23A #16 : 13A	#12 : 23A #16 : 13A	#8 : 46A #12 : 23A

Number of Contact	10		11		13
Insert Arrangement					
Insert Number	18-1	18-19	24-20	20-33	20-11
Contact Size	10-#16	10-#16	2-#12, 9-#16	11-#16	13-#16
Service Rating	A (BCFG) INST	A	D	A	INST
Rated Current	13A	13A	#12 : 23A #16 : 13A	13A	13A

Number of Contact	14			
Insert Arrangement				
Insert Number	20-27	22-19	28-20	32-9
Contact Size	14-#16	14-#16	10-#12, 4-#16	2-#4, 12-#16
Service Rating	A	A	A	D
Rated Current	13A	13A	#12 : 23A #16 : 13A	#4 : 80A #16 : 13A

Contact Size Symbol	●	⊕	⊗	⊙	⊕	⊕
	#16	#12	#8	#4	#0	
Service Rating	INST	A	D	E		
Rated Voltage AC(r.m.s)	200	500	900	1,250		
Rated Voltage DC	250	700	1,200	1,750		
Contact Size	#16	#12	#8	#4	#0	
MAX Current /Contact	13	23	46	80	150	

© Specifications and/or dimensions in this catalog are subject to change without notice.
Please verify the latest specifications with our drawings.

▶ Insert Arrangement List

Number of Contact	16		17	19	20
Insert Arrangement					
Insert Number	24-5		24-7	20-29	22-14
Contact Size	16-#16		2-#12, 14-#16	17-#16	19-#16
Service Rating	A		A	A	A
Rated Current	13A		#12 : 23A #16 : 13A	13A	13A
Number of Contact	22	24	26	30	
Insert Arrangement					
Insert Number	28-11	24-28	28-12	32-8	
Contact Size	4-#12, 18-#16	24-#16	26-#16	6-#12, 24-#16	
Service Rating	A	INST	A	A	
Rated Current	#12 : 23A #16 : 13A	13A	13A	#12 : 23A #16 : 13A	
Number of Contact	31	35		37	
Insert Arrangement					
Insert Number	36-9	28-15	32-7	28-21	
Contact Size	1-#4, 2-#8, 14-#12, 14-#16	35-#16	7-#12, 28-#16	37-#16	
Service Rating	A	A	INST (ABhj) A	A	
Rated Current	#4 : 80A #8 : 46A #12 : 23A #16 : 13A	13A	#12 : 23A #16 : 13A	13A	
Number of Contact	48	52	54	73	
Insert Arrangement					
Insert Number	36-10	32-414	32A-10	36-73	
Contact Size	48-#16	52-#16	54-#16	73-#16	
Service Rating	A	A	A	A	
Rated Current	13A	13A	13A	13A	

Contact Size Symbol	●	⊕	⊗	⊙	⊚	⊛
	#16	#12	#8	#4	#0	
Service Rating	· · · · ·	INST	A	D	E	
Rated Voltage AC(r.m.s.)	200	500	900	1,250		
Rated Voltage DC	· · ·	250	700	1,200	1,750	
Contact Size	· · · · ·	#16	#12	#8	#4	#0
MAX Current /Contact	· · · · ·	13	23	46	80	150

© Specifications and/or dimensions in this catalog are subject to change without notice.
Please verify the latest specifications with our drawings.

▶ Insert Arrangement List

● symbol means both pin and receptacle contacts are available

Insert No.	Number of Contact	Service Rating	Contact Size					Alternate Insert Key			
			#0	#4	#8	#12	#16	W	X	Y	Z
12S-3	2	A					2	70°	145°	215°	290°
14S-1	3	A					3	—	—	—	—
14S-2	4	INST					4	—	120°	240°	—
14S-5	5	INST					5	—	110°	—	—
14S-6	6	INST					6	—	—	—	—
14S-7	3	A					3	90°	180°	270°	—
14S-9	2	A					2	70°	145°	215°	290°
16S-1	7	A					7	80°	—	—	280°
16S-5	3	A					3	70°	145°	215°	290°
16S-8	5	A					5	—	170°	265°	—
16-10	3	A				3		90°	180°	270°	—
18-1	10	A					4	70°	145°	215°	290°
		INST				6	—	120°	240°	—	
18-4	4	D				4	35°	110°	250°	325°	
18-5	3	D				2	1	80°	110°	250°	280°
18-8	8	A				1	7	70°	—	—	290°
18-10	4	A				4		—	120°	240°	—
18-11	5	A				5		—	170°	265°	—
18-12	6	A					6	80°	—	—	280°
18-19	10	A					10	—	120°	240°	—
18-20	5	A					5	90°	180°	270°	—
18-21	3	A				3		—	—	—	—
18-22	3	D					3	70°	145°	215°	290°
20-2	1	D	1					—	—	—	—
20-4	4	D				4		45°	110°	250°	325°
20-7	8	D					4	80°	110°	250°	280°
		A				4					
20-11	13	A					13	—	—	—	—
20-15	7	A				7		80°	—	—	280°
20-16	9	A				2	7	80°	110°	250°	325°
20-17	6	A				5	1	90°	180°	270°	—
20-18	9	A				3	6	35°	110°	250°	325°
20-22	6	A			3		3	80°	—	—	280°
20-23	2	A			2			35°	110°	250°	325°
20-27	14	A					14	35°	110°	250°	325°
20-29	17	A					17	80°	—	—	280°
20-33	11	A					11	—	—	—	—

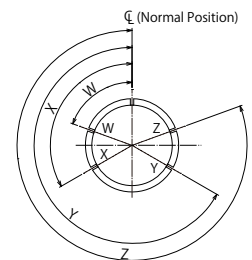

Front face of Pin Insert or Rear face of socket insert

© Specifications and/or dimensions in this catalog are subject to change without notice.
Please verify the latest specifications with our drawings.

<http://www.ddknet.co.jp>

▶ Insert Arrangement List

Insert No.	Number of Contact	Service Rating	Contact Size					Alternate Insert Key				
			#0	#4	#8	#12	#16	W	X	Y	Z	
22-2	3	D			3			70°	145°	215°	290°	
22-10	4	E					4	35°	110°	250°	325°	
22-14	19	A					19	80°	110°	250°	280°	
22-19	14	A					14	80°	110°	250°	280°	
22-22	4	A			4			—	110°	250°	—	
22-23	8	D				1		35°	—	—	—	
		A				7						
22-28	7	A				7		80°	—	—	280°	
24-2	7	D				7		80°	—	—	280°	
24-5	16	A					16	80°	110°	250°	280°	
24-7	16	A				2	14	80°	110°	250°	280°	
24-10	7	A			7			80°	—	—	280°	
24-11	9	A			3	6		35°	110°	250°	325°	
24-20	11	D				2	9	80°	110°	250°	280°	
24-22	4	D			4			45°	110°	250°	—	
24-28	24	INST					24	80°	110°	250°	280°	
28-6	3	D		3				70°	145°	215°	290°	
28-10	7	D				1		80°	110°	250°	280°	
		A		2	2	2						
28-11	22	A				4	18	80°	110°	250°	280°	
28-12	26	A					26	90°	180°	270°	—	
28-15	35	A					35	80°	110°	250°	280°	
28-16	20	A					20	80°	110°	250°	280°	
28-20	14	A					10	4	80°	110°	250°	280°
28-21	37	A						37	80°	110°	250°	280°
32-1	5	E				1		80°	110°	250°	280°	
		D	2			2						
32-2	5	E		3			2	70°	145°	215°	290°	
32-5	2	D	2					35°	110°	250°	325°	
32-7	35	A				7	24	80°	125°	235°	280°	
		INST					4					
32-8	30	A				6	24	80°	125°	235°	280°	
32-9	14	D		2			12	80°	125°	250°	280°	
32A-10	54	A					54	—	—	—	—	
32-17	4	D		4				45°	110°	250°	—	
32-414	52	A					52	80°	110°	250°	280°	
36-3	6	D	3				3	70°	145°	215°	290°	
36-4	3	D	1					70°	145°	215°	290°	
		A	2									
36-5	4	A	4					—	120°	240°	—	
36-9	31	A		1	2	14	14	80°	125°	235°	280°	
36-10	48	A					48	80°	110°	250°	280°	
36-73	73	A					73	80°	110°	250°	280°	

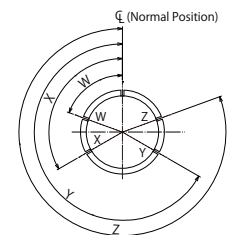

Front face of Pin Insert or Rear face of socket insert

© Specifications and/or dimensions in this catalog are subject to change without notice.
Please verify the latest specifications with our drawings.

▶ DCA3100A Wall Mount Receptacle

DCA3100A14S-10PY -BSN-F

① ② ③ ④

① Shell Size	14S
② Insert Arrangement	Refer to page 3-6.
③ Contact Type	P : Pin Contact, S : Socket Contact
④ Alternate Key Positions	Omit : Standard Position, W,X,Y,Z : Refer to page 7-8.

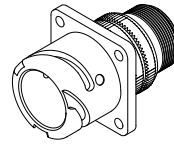

DCA3100A-F is a receptacle connector which is mounted on the panel or the chassis with the cable terminated on the backend. This can mate with all of DCA plug connectors.

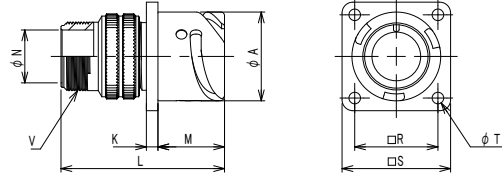

◎ Cable clamp (DMS3057- □□ A-F) is available.

Shell Size	φ A	K	L	M	φ N	□ R	□ S	φ T	Thread V
12S									
14S	24.53	3.2	45.2	18.4	14.61	23	30	3.2	3/4-20UNEF
16S									
16									
18									
20									
22									
24									
28									
32									
36									

○ Size 14S : Under Development - Available April 2016

Panel Mounting Dimension

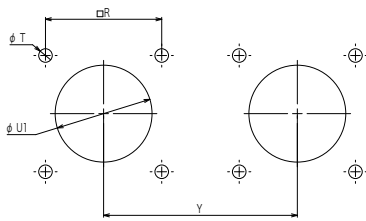

Rear Mounting

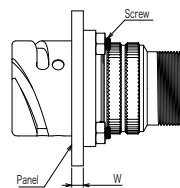

Shell Size	Y min. (Ref)	□ R	φ T	U1 Min. (Rear Mounting)	W max. Panel Thickness(Ref.)	Screw Size (Ref)	F Gasket
12S							
14S	60	23	3.2	25.5	5	M3	DCA-14SFG
16S, 16							
18							
20							
22							
24							
28							
32							
36							

◎ Specifications and/or dimensions in this catalog are subject to change without notice. Please verify the latest specifications with our drawings.

▶ DCA3101A Cable Receptacle

DCA3101A18-10PY-BSN-F

① ② ③ ④

① Shell Size	14S, 16S, 16, 18, 20, 22, 24, 28
② Insert Arrangement	Refer to page 3-6.
③ Contact Type	P : Pin Contact, S : Socket Contact
④ Alternate Key Positions	Omit : Standard Position, W,X,Y,Z : Refer to page 7-8.

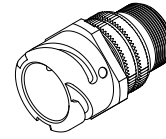

DCA3101A-F is a cable receptacle connector (in-line receptacle connector), which is not mounted on the panel, to be used for connecting the cable with the cable. This can mate with all of DCA-F plug connectors.

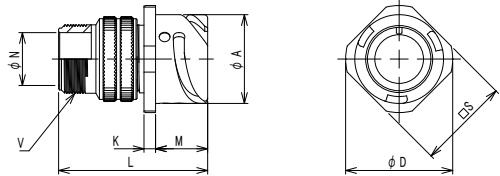

◎ Cable clamp(DMS3057- □□ A-F)is available.

Shell Size	φ A	φ D	K	L	M	φ N	□ S	Thread V
12S								
14S	24.53	29.6	3.2	41.2	14.4	14.61	25.4	3/4-20UNEF
16S	27.33	32.1	3.2	42.7	14.4	17	28.6	7/8-20UNEF
16	27.33	32.1	3.2	50	19.2	17	28.6	7/8-20UNEF
18	30.73	34.6	4	52.5	19.2	20.5	31.7	1-20UNEF
20	34.13	37.6	4	57.4	19.2	24.84	34.9	1 3/16-18UNEF
22								
24	40.83	44.4	4	55.8	20.8	31	41.3	1 7/16-18UNEF
28	16.63	50.7	4	56.9	20.8	28.7	47.6	1 7/16-18UNEF
32								
36								

○ Size 14S, 18, 20 : Under Development - Available April 2016

○ Size 16S, 16, 24, 28 : Under Development - Available June 2016

▶ DCA3102A Box Mount Receptacle

DCA3102A18-10PY-F

① ② ③ ④

① Shell Size	14S, 16S, 16, 18, 20, 22, 24, 28
② Insert Arrangement	Refer to page 3-6.
③ Contact Type	P : Pin Contact, S : Socket Contact
④ Alternate Key Positions	Omit : Standard Position, W,X,Y,Z : Refer to page 7-8.

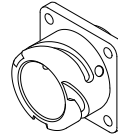

DCA3102A-F is a receptacle connector which is mounted on the panel. This can mate with all of DCA-F plug connectors.

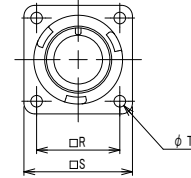
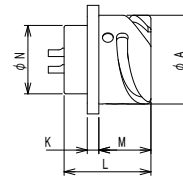

Shell Size	φ A	K	L	M	φ N	□ R	□ S	φ T
12S								
14S	24.53	3.2	24	14.4	18.9	23	30	3.2
16S	27.33	3.2	24	14.4	22.02	24.6	32.5	3.2
16	27.33	3.2	34.4	19.2	22.02	24.6	32.5	3.2
18	30.73	4	34.4	19.2	25.2	27	35	3.2
20	34.13	4	34.4	19.2	28.4	29.4	38	3.2
22								
24	40.83	4	34.4	20.8	34.72	34.9	44.5	3.7
28	46.63	4	34.4	20.8	41.07	39.7	50.8	3.7
32								
36								

- Size 14S, 18, 20 : Under Development - Available April 2016
- Size 16S, 16, 24, 28 : Under Development - Available June 2016

Panel Mounting Dimension

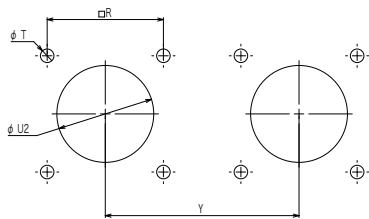

Front Mounting

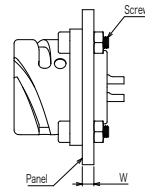

Shell Size	Y(Ref.)	□ R	φ T	U2 (Front Mounting)	W Panel Thickness(Ref.)	Screw Size(Ref)	R Gasket
12S							
14S	60	23	3.2	19.9	-	M3	DMSE-14SRG
16S, 16	63	24.6	3.2	23	-	M3	DMSE-16RG
18	67	27	3.2	26.2	-	M3	DMSE-18SRG
20	70	29.4	3.2	29.4	-	M3	DMSE-20SRG
22							
24	81	34.9	3.7	35.7	-	M3.5	DMSE-24RG
28	87	39.7	3.7	42	-	M3.5	DMSE-28RG
32							
36							

© Specifications and/or dimensions in this catalog are subject to change without notice. Please verify the latest specifications with our drawings.

▶ DCA3102A PCB Mount Type Receptacle

DCA3102A18-1PY-F(D31)

① ② ③ ④ ⑤

① Shell Size	14S, 16S, 16, 18, 20, 22, 24, 28
② Insert Arrangement	Refer to page 3-6.
③ Contact Type	P : Pin Contact, S : Socket Contact
④ Alternate Key Positions	Omit : Standard Position, W,X,Y,Z : Refer to page 7-8.
⑤ Deviation	(D31):PCB mount type

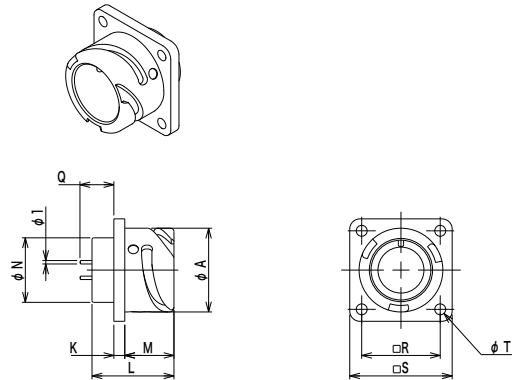

DCA3102A-F(D31) is the PCB mount type receptacle connector (contact size #16 only).

This can mate with all of DCA-F plug connector.

Please contact us about the PCB dimensions.

Shell Size	φ A	K	L	M	φ N	Q	□ R	□ S	φ T
12S									
14S	24.53	3.2	24	14.4	18.9	10	23	30	3.2
16S	27.33	3.2	24	14.4	22.02	9.7	24.6	32.5	3.2
16									
18	30.73	4	34.4	19.2	25.2	14.8	27	35	3.2
20	34.13	4	34.4	19.2	28.4	14.8	29.4	38	3.2
22									
24	40.83	4	34.4	20.8	34.72	13.2	34.9	44.5	3.7
28	46.63	4	34.4	20.8	41.07	13.2	39.7	50.8	3.7
32									
36									

○ Size 14S, 18, 20 : Under Development - Available April 2016

○ Size 16S, 24, 28 : Under Development - Available June 2016

Panel Mounting Dimension

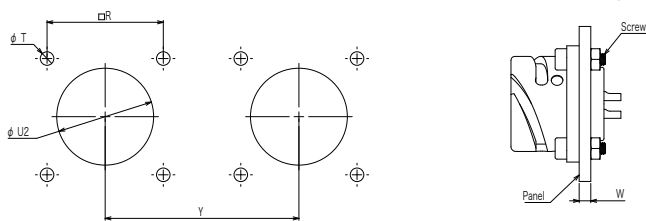

Shell Size	Y(Ref.)	□ R	φ T	U2 (Front Mounting)	W Panel Thickness(Ref.)	Screw Size(Ref)	R Gasket
12S							
14S	60	23	3.2	19.9	-	M3	DMSE-14SRG
16S, 16	63	24.6	3.2	23	-	M3	DMSE-16RG
18	67	27	3.2	26.2	-	M3	DMSE-18SRG
20	70	29.4	3.2	29.4	-	M3	DMSE-20SRG
22							
24	81	34.9	3.7	35.7	-	M3.5	DMSE-24RG
28	87	39.7	3.7	42	-	M3.5	DMSE-28RG
32							
36							

© Specifications and/or dimensions in this catalog are subject to change without notice.
Please verify the latest specifications with our drawings.

▶DCA3106A Straight Plug (Solid Shell)

DCA3106A18-10PY-BSN-F

① ② ③ ④

① Shell Size	14S, 16S, 16, 18, 20, 24, 28
② Insert Arrangement	Refer to page 3-6.
③ Contact Type	P : Pin Contact, S : Socket Contact
④ Alternate Key Positions	Omit: Standard Position, W,X,Y,Z : Refer to page 7-8.

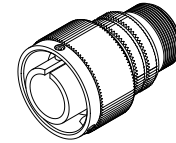

DCA3106A-F type is a plug connector which is straight to relay another receptacle connector. This plug connector can mate with all of DCA-F receptacle connectors.

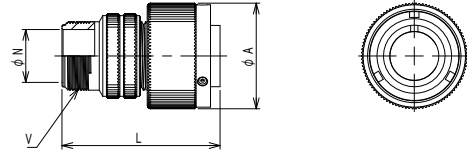

◎ Cable clamp (DMS3057- □□ A-F) is available.

Shell Size	φ A	L	φ N	Thread V
12S				
14S	29.2	43.7	14.61	3/4-20UNEF
16S	32	45.2	17	7/8-20UNEF
16	32	51.4	17	7/8-20UNEF
18	36.5	53	20.5	1-20UNEF
20	39.9	57.9	24.84	1 3/16-18UNEF
22				
24	46.6	59	31	1 7/16-18UNEF
28	53.4	59.6	28.7	1 7/16-18UNEF
32				
36				

○ Size 14S, 18, 20 : Under Development - Available April 2016

○ Size 16S, 16, 24, 28 : Under Development - Available June 2016

▶ Cable Clamp

DMS3057- □□ A-F

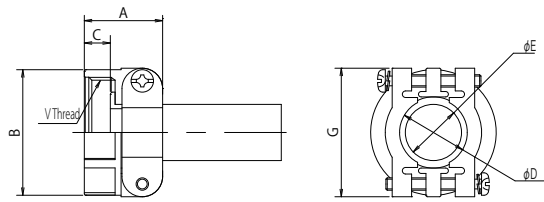

DMS3057- □□ A-F is an accessory which is used together with a backshell to fasten the cable. The cable is fixed in the center of the cable clamp for sure since the cable is fixed from both directions with two pieces of the metal clamps and the screws. The jacketed cable can be used with this cable clamp as well because a rubber bushing shown on the table below is inserted.

Part Number	Shell Size	A±0.7	B±0.7	C±0.4	D	E	G±0.7	V	Bushing Part Number
DMS3057-4A-F	12S	20.6	20.6	9.0	7.9	5.6	22.2	5/8-24UNEF	AN3420-4
DMS3057-6A-F	14S	22.2	24.6	9.0	11.2	7.9	27.0	3/4-20UNEF	AN3420-6
DMS3057-8A-F	16S,16	23.8	27.8	9.0	14.3	11.1	29.4	7/8-20UNEF	AN3420-8
DMS3057-10A-F	18	23.8	30.1	9.0	15.9	14.3	31.7	1-20UNEF	AN3420-10
DMS3057-12A-F	20,22	23.8	35.0	9.0	19.0	15.9	37.3	1 3/16-18UNEF	AN3420-12
DMS3057-16A-F	24,28	26.2	42.1	9.0	23.8	19.1	42.9	1 7/16-18UNEF	AN3420-16
DMS3057-20A-F	32	27.8	51.6	11.0	31.7	23.8	51.6	1 3/4-18UNS	AN3420-20
DMS3057-24A-F	36	29.4	56.4	10.5	34.9	31.8	58.0	2-18UNS	AN3420-24

▶ Rubber Bushing

AN3420- □□

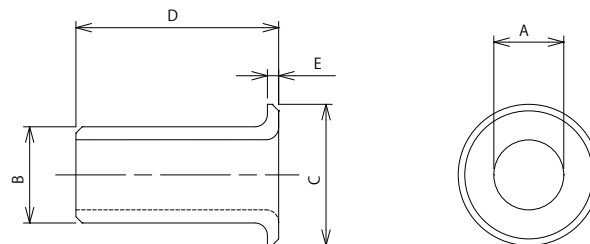

AN3420- □□ is an accessory which is designed to tighten the cable. When you need thinner cable, you can duplicate or triplicate the rubber bushings.

Part Number	φ A	φ B	φ C	D±0.7	E
AN3420-4	5.6	7.7	14.5	69.8	2.3
AN3420-6	7.9	10.8	17.5	66.7	2.3
AN3420-8	11.1	14.0	20.8	63.5	2.3
AN3420-10	14.3	15.6	23.7	60.3	2.3
AN3420-12	15.9	18.8	28.2	57.2	2.3
AN3420-16	19.1	23.5	35.0	54.0	2.9
AN3420-20	23.8	31.5	42.8	50.8	2.9
AN3420-24	31.8	34.7	48.8	47.6	2.9

© Specifications and/or dimensions in this catalog are subject to change without notice. Please verify the latest specifications with our drawings.

▶ Waterproof Metal Cap & Chain for Plug

DCA PC- □□□□ -F
 ① ② ③

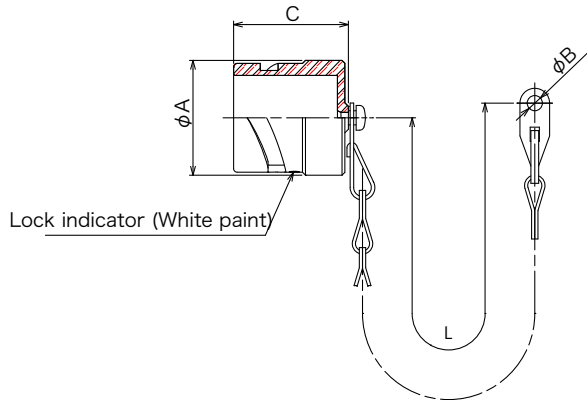

Part Number	Shell Size	$\phi A \pm 0.3$	$\phi B \begin{smallmatrix} +0.3 \\ 0 \end{smallmatrix}$	C	L
DCAPC-10SL-F	10SL	20.2	4.3	24.5	120
DCAPC-12S-F	12S	23.2	4.3	24.5	120
DCAPC-14S-F	14S	26.5	4.3	24.5	120
DCAPC-16S-F	16S	29.0	4.3	24.5	120
DCAPC-16-F	16	29.0	4.3	32.5	135
DCAPC-18-F	18	32.5	4.3	32.5	135
DCAPC-20-F	20	36.0	4.7	32.5	150
DCAPC-22-F	22	39.0	4.7	32.5	150
DCAPC-24-F	24	42.5	4.7	32.5	150
DCAPC-28-F	28	48.5	4.7	32.5	210
DCAPC-32-F	32	55.0	5.5	32.5	210
DCAPC-36-F	36	61.5	5.5	32.5	210

▶ Waterproof Metal Cap & Chain for Receptacle

DCA RC- □□□□ -F
 ① ② ③

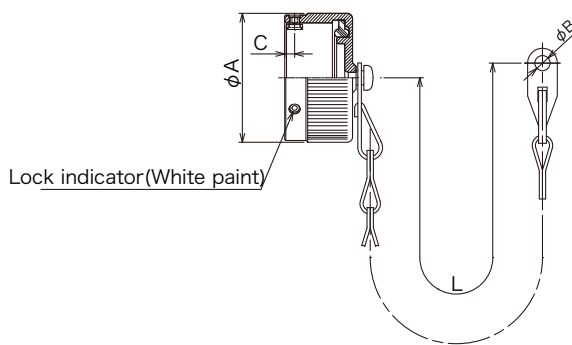

Part Number	Shell Size	$\phi A \pm 0.3$	$\phi B \begin{smallmatrix} +0.3 \\ 0 \end{smallmatrix}$	C	L
DCARC-10SL-F	10SL	22.8	4.3	2.3	110
DCARC-12S-F	12S	25.6	4.3	2.3	110
DCARC-14S-F	14S	29.2	4.3	2.3	110
DCARC-16S-F	16S	32.0	4.3	2.3	110
DCARC-16-F	16	32.0	4.3	2.54	120
DCARC-18-F	18	36.5	4.3	2.54	120
DCARC-20-F	20	39.9	4.3	2.54	135
DCARC-22-F	22	43.1	4.3	2.54	135
DCARC-24-F	24	46.6	4.3	2.54	135
DCARC-28-F	28	53.4	5.5	2.54	180
DCARC-32-F	32	60.0	5.5	2.54	180
DCARC-36-F	36	65.0	5.5	2.54	180