

THESE DRAWINGS ARE THE PROPERTY OF QUALTEK ELECTRONICS AND NOT TO BE REPRODUCED FOR OR COMMUNICATED TO A THIRD PARTY WITHOUT THE EXPRESS WRITTEN PERMISSION OF AN OFFICER OF QUALTEK ELECTRONICS.

| REVISION | | | |
|----------|-------------|------|----------|
| REV. | DESCRIPTION | DATE | APPROVED |
| | | | |
| | | | |
| | | | |

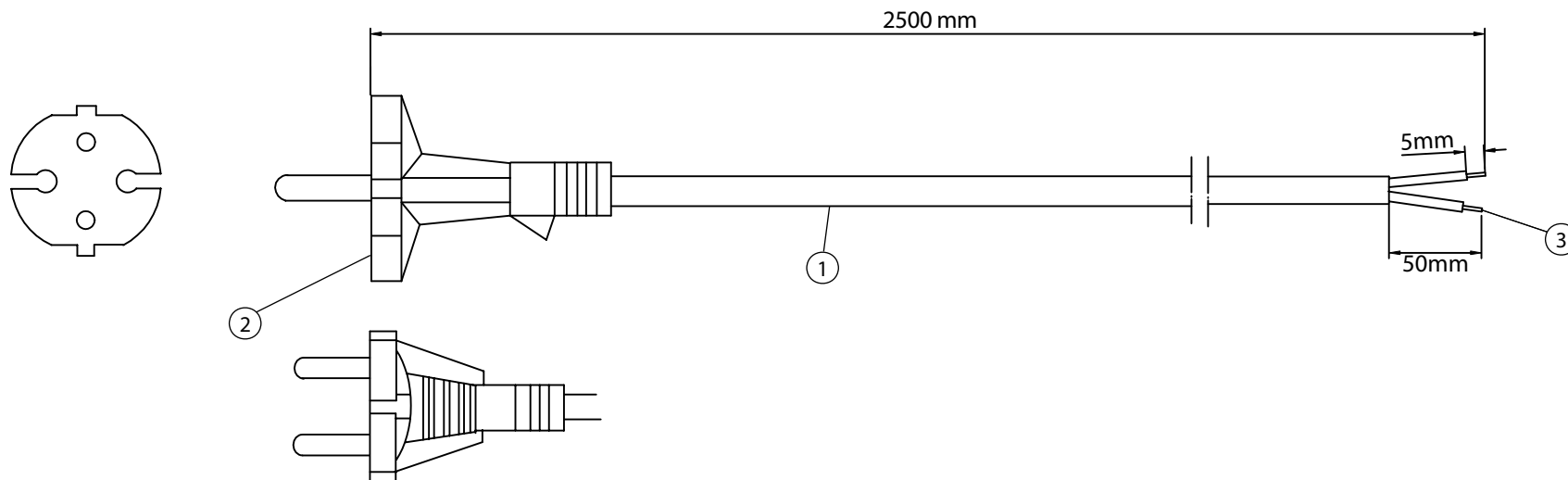

CONTROLLED

NOTES:

1. CORDAGE: H05VV-F, 2x0.75mm, UNSHIELDED, CEE COLOR CODE, TEMP. RATING 70°C, RATING: 250V 6A, JACKET COLOR: BLACK
2. PLUG: CONTINENTAL EUROPE
3. OTHER END: ROJ 50mm STRIP 5mm
4. APPROVALS: GERMANY, SWITZERLAND, DENMARK, NORWAY, FINLAND, FRANCE, BELGIUM, ITALY, NETHERLANDS, SWEDEN, AUSTRIA
5. ROHS COMPLIANT

| Dim range (mm) | Tolerance +/- (mm) | Qualtek Electronics Corp. PPC DIVISION | | |
|----------------|--------------------|---|----------------|-----------------|
| 0-1 | 0.15 | Part Number: 362004-E01 | | RoHS Compliant |
| 1-6 | 0.20 | Description: POWER CORD | | |
| 6-18 | 0.30 | | UNIT: mm | REV. B |
| 18-50 | 0.50 | Drawn / Date | Checked / Date | Approved / Date |
| 50-120 | 0.70 | R.Nuti 08-22-07 | 08-22-07 | JJH / 08-22-07 |
| 120-250 | 0.90 | | | |
| 250-500 | 1.20 | | | |