



Industrie und Luftfahrtelektronik GmbH

SN10 / SN10B User Manual

Software Version 2.31



Industrie und Luftfahrtelektronik GmbH
Friedrich-Puchta-Straße 6 • D-95444 Bayreuth, Germany
Telephone 0921 / 13733 • Fax 0921/82731

ILECgmbh@t-online.de

www.ilec-gmbh.com

Foreword

Thank you for purchasing one of the finest and most reliable sailplane instruments available, and for the trust you have placed in us. Our goal is to make your soaring more enjoyable and productive by minimizing cockpit time spent on calculation and planning. This means more time looking out of the cockpit, for faster and safer soaring.

Before flying with the SN10, please take the time to read this manual, preferably with an operating SN10 or the SN10 demonstration program. This manual will help you configure and install your new SN10, and aid you in using the SN10 to best advantage during flight. If you haven't already done so, we recommend you step through the SN10 demonstration program's narrated introduction (this demonstration program runs on any computer equipped with Microsoft Windows, and is available from ILEC or your dealer's Web site).

The opinions of our customers are important to us ! Please send us your comments and suggestions (ILECgmbh@t-online.de or Nadler & Associates <drn@Nadler.com>).

Happy and Safe Soaring from Nadler & Associates and ILEC GmbH !

WARNING	<p>No instrument, SN10 or otherwise, can replace pilotage and judgment. The SN10 provides base-line calculations and important information, but is not a replacement for your certificated primary flight instruments and may not be used as such. If the SN-10 receives incorrect inputs, the SN10 will display incorrect and possibly dangerous information.</p> <p>All decisions during flight must be made by the pilot !</p>
----------------	---

Legal Notices

This manual, the SN10 software, and the SN10 user interface design are the copyrighted property of Nadler & Associates, all rights reserved. With an SN10 purchase, you receive the right to use the SN10 software and the SN10 user interface within the instrument you purchased, but you do not own or have any rights to this software or interface. Any decompiling, disassembly, or reverse engineering, and any use of the SN10 software or the SN10 user interface for any other purpose or with any other instrument, are strictly prohibited without prior written permission from Nadler & Associates. In addition, other than for your personal use, for the use of other SN10 customers, and for backup purposes, you are not permitted to copy the SN10 software or this manual, which are for the use of ILEC customers only.

DOS, MS-DOS, Windows, Windows 95, Windows 98, Windows NT, Windows XP, and Windows 2000 are trademarks of Microsoft Corporation. Connectix Virtual PC is a trademark of Connectix Corporation. Apple, Mac, Macintosh, and Powerbook are trademarks of Apple Computer, Inc.

Table of Contents

1	What is the ILEC SN10 / SN10B flight computer? -----	1
2	Learning to Use Your SN10 -----	2
2.1	The SN10 Controls	2
3	SN10 Flight Pages – Competition Mode -----	3
3.1	Task Page	4
3.2	Status Page	6
3.3	Thermal Heightband Page (optional)	7
3.4	Moving Map Page	8
3.4.1	Alternate Landing Points on the Moving Map Page	9
3.5	Measured Wind Page	10
3.6	Alternates Page	12
3.7	GPS Page	14
3.8	Timer Page	15
3.9	Flight Summary Page	16
3.10	L/D Calculator Page (optional)	16
3.11	Vario Tuning Page	17
3.12	Simple Final Glide Page (optional)	18
3.13	Custom Page (optional)	19
4	The SN10 Database -----	20
4.1	Types of Points (Point Attribute Codes)	21
4.2	Point Short Names and Order of Point Display	22
4.3	Point Elevation	22
4.4	Point 5-Line Description	22
4.5	Airport Identifier (ICAO code)	22
4.6	SN10-Generated Points	23
4.7	Special Notes on Points Edited at SN10	23
5	Configuring the SN10 (Setup Pages) -----	24
5.1	Audio Setup	24
5.2	Variometer Setup	25
5.2.1	Variometer Choices	25
5.2.2	Selectable Averager Choices	26
5.3	Units Setup	27
5.4	Site Select	28
5.5	Point Edit	29
5.6	Glider Polar Setup	30
5.7	Airspeed Calibration Setup	31
5.8	SN10 Options 1 Setup	31
5.8.1	Map Alternates	31
5.8.2	Camera (Suppress <i>Near Turnpoint</i> alert)	31
5.8.3	Photo Start	31
5.8.4	2-Seat LCD Contrast	32
5.8.5	Task: <i>Competition</i> or <i>Touring</i>	32
5.8.6	Cruise/Climb Switching	32

5.8.7	GPS Type	32
5.8.8	Language	32
5.9	SN10 Options 2 Setup	33
5.9.1	Enable Club Mode	33
5.9.2	Enable PDA Output	33
5.9.3	Be Quiet in Sink	33
5.9.4	Enable Arrows in Climb	33
5.9.5	Enable The Custom Page	33
5.9.6	Enable L/D Calculator Page	33
5.9.7	Enable Simple Final Glide Page	34
5.9.8	Enable Heightband Page	34
5.10	SN10 Resets	35
5.10.1	Options	35
5.10.2	Reboot	35
5.10.3	SN10 Point Edits	35
5.10.4	Custom Page Form	35
5.10.5	Factory 0	35
5.10.6	Load	35
5.11	Raw Sensors Diagnostic Page	36
5.12	Customizing the <i>Custom</i> Page	37
5.13	Task Rules Page	38
5.13.1	Start and Finish Cylinders	38
5.13.2	Start and Finish Lines	39
5.14	Flight Recorder Page	40
6	Using the SN10 with Your PC -----	41
6.1	Installing SN10 Support Software on Your PC	42
6.2	Using SN10 PC Software with MS-DOS or Windows 3.x	43
6.3	Using Prepared Site Database Files (NDB files)	43
6.4	Starting the SN10 to PC Link	44
6.4.1	Start the PCLink (HostLink) Program on the PC	44
6.4.2	Connect the PC to the SN10 with the ILEC PC Cable	44
6.4.3	Trouble-Shoot (If Required)	45
6.5	Upload an NDB file from a PC to the SN10	46
6.6	Download a Flight Record from the SN10 to a PC	47
6.7	Preparing a Custom Site Database File (NDB file)	48
6.8	Preparing Map Data for Use with the SN10	48
6.9	Updating the SN10 Operating Software	49
6.10	Updating the 2 nd Seat SN10-2 Operating Software	50
6.11	Communication Problems with Microsoft Windows 98 & ME	51
6.12	Communication Problems with Microsoft Windows NT, 2000, XP	52
6.13	USB Serial Communication Problems	52
7	SN10 Club Mode -----	53
7.1	Club Mode Final Glide Page	54
7.1.1	Club Mode Alternates	54
7.2	Club Mode Settings Page	56
7.3	Club Mode Moving Map Page	56

7.3.1	Alternate Landing Points on the Club Moving Map Page	57
7.4	Club Mode Wind Page	58
7.5	Club Mode Setup	58
8	Assigned Area Task (AAT) -----	59
8.1	Entering an AAT Task	59
8.2	The Task Page in AAT Mode	60
8.3	Adjusting AAT Turnpoints	60
8.4	AAT In Flight	61
8.5	AAT Notes	61
9	SN10 Installation -----	62
9.1	Installation Preparation	62
9.2	Installing the SN10 Main Unit	63
9.3	Temperature Probe Installation	64
9.4	Pneumatic Connections	64
9.5	Electrical Connections	64
9.6	Installing the optional Remote Control	65
9.7	Installing an External Speaker	65
9.8	Guidelines for Pneumatic Plumbing	65
9.9	Guidelines for Electrical Wiring	66
9.10	Installation Checklist	67
9.10.1	Safety Check Before First Flight	67
9.10.2	SN10 Configuration Check Before First Flight	68
	Appendix A: Frequently Asked Questions -----	69
	Appendix B: Suggested Pre-Flight Checklists -----	71
	Competition Mode Takeoff Checklist	71
	Club Mode Takeoff Checklist	72
	Appendix C: Specifications -----	73
	Mechanical Specifications	73
	General Specifications	74
	Appendix D: Wiring Information -----	75
	Main SN10 Connector (15-pin, DB15 female, bottom)	77
	PC/GPS and remote control (serial numbers to xx0099)	78
	PC/GPS and remote control (serial numbers xx0100 up)	79
	Connector for Two-seater repeater (9-pin, DB9 female, left)	80
	Panel Cable and PC Cable Diagram	81
	SN10 to Volkslogger RJ-45 Wiring	82
	SN10 to Cambridge Aero Instruments Flight Recorder Wiring	83
	Appendix E: Using The SN10 Without GPS -----	84
	Position Tracking During The Task without GPS	84
	Flight Segments for No-GPS Wind Estimation	85
	No-GPS Position and Wind Calculations During the Task	85
	Position Fixes (No-GPS)	85
	Arriving at a Turnpoint (no-GPS)	85

Appendix F: Quick Setup Guides -----	87
USA Nationals	87
Badge Flights	87
Appendix G: Using the SN10 with a Volkslogger -----	88
Appendix H: Warranty and Repair -----	89
ILEC Manufacturer’s Warranty	89
Returning an Instrument to ILEC for Repair	89
Index -----	90

1 What is the ILEC SN10 / SN10B flight computer?

The SN10 gives you the state of the art in sailplane variometer and computer functions. It provides the world-renowned ILEC variometer and audio, plus solid state sensors for airspeed, altimeter, and G load. An optional GPS satellite navigation sensor is also available. Wind measurement, final glide computations, moving map, and flight recording features are all included. The SN10B is the current model, featuring a higher resolution and contrast screen (an SN10 can be upgraded to SN10B).

You really have two instruments in one with the SN10 – one optimized for competition, record and task flying, and another optimized for club pilots. In the “club” mode, the SN10 provides a moving map with airspace boundaries, final glide home, final glide to alternates, and wind measurement with a simple, easy to use, interface.

For the competition, record or task pilot, the SN10 computer provides a wide range of flight planning and analysis functions. A user configurable turnpoint library eases task planning and alternate landing site selection. Continuous estimation of time and altitude required to complete a task provides superb task progress tracking with little effort from the pilot. For tasks determined during flight, the pilot can ask the SN10 "what-if" type questions to determine the best task for the time remaining. A simple glideslope presentation, coupled with an accurate digital altimeter, provides final glide monitoring without arithmetic. The unique thermal heightband graph allows easy monitoring of lift conditions through the day and eases 'time-to-leave-this-thermal' decisions.

In summary, the SN10 provides:

- The superb ILEC Variometer and Audio
- Instant On-Screen Help (in English or German)
- Automatic Wind Calculation (direction and speed)
- Databases for Two Sites (Airfields, Turnpoints Airspace),
- Alternate airfield Locator with “Go To” feature
- Moving Map of Task and Airspace
- Optional GPS, or NMEA GPS input from your GPS or GPS-Datalogger
- Easy In-Flight Task Problem Solving
- Easy Final Glides around Turnpoints (even multiple turnpoints)
- Flight Recorder (approved for OLC Online contest)
- Integrated G-Meter
- Exclusive Thermal Height-Band Display
- Easy Data Transfer To and From your PC
- All Settings and Computations Preserved when Powered Off - No problems if power is momentarily interrupted during flight !
- Easy Software and Database updates using your PC

Even with this long list of features, the SN10 is extremely easy to learn, and requires absolutely minimal heads-down time in the cockpit.

2 Learning to Use Your SN10

If you haven't already done so, we recommend you step through the SN10 demonstration program's narrated introduction (the demonstration program runs on any computer equipped with Microsoft Windows, and is available from the web site of ILEC or your dealer). The demonstration program provides an excellent overview of SN10 operation and takes only a short time to view.

Next, please take the time to read this manual, preferably while working with an SN10 or the SN10 demonstration program. This manual will familiarize you with the operation of your SN10. Later in the manual you will find chapters to help you quickly install and configure your new SN10 if this has not already been done.

2.1 The SN10 Controls

The SN10 is operated using the knobs on the face of the instrument, or using the optional remote control unit. The knob at the top of the instrument is the on/off and volume control. At the bottom of the instrument are the **PAGE**, **CURSOR**, and **VALUE** knobs.

Turn the **PAGE** knob to select different SN10 pages. The **CURSOR** knob selects which field is active, indicated by the highlighted letters/numbers on the screen. In the picture at right, the cursor is on MC (MacCready). The **VALUE** knob changes the value of the currently selected field. In the picture at right, turning **VALUE** would change the MacCready setting.

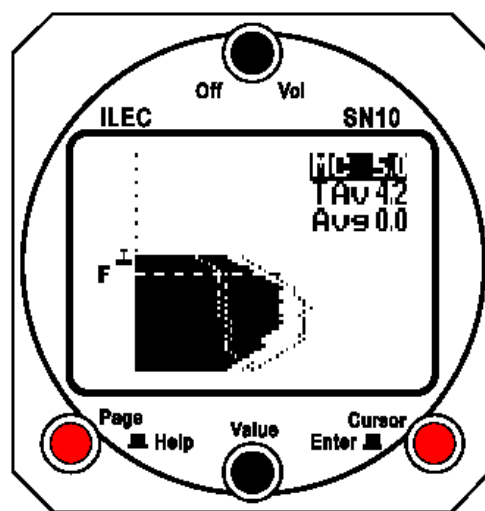

When you want to make a big change, spin the knob fast. Spinning the **PAGE** knob fast will move to the first or last page of the SN10. Spinning the **VALUE** knob fast lets you move quickly through a long list of turnpoints or change a number by a big amount.

Press **HELP** to get a detailed explanation for the selected field (press in the **PAGE** knob). Hold in the **HELP** button to see the help text for the currently selected field, including the units of measurement. When you release the button, the help text disappears and the normal screen is restored. For a few fields a second page of help is provided when you release **HELP**; press and release **HELP** a second time to clear the second page.

The **ENTER** button is on the right, but is rarely required. If you want to change the MacCready value, just turn the **VALUE** knob (you don't have to press **ENTER**).

In a two-seat configuration the two SN10 screens and controls operate together; both pilots always see the same display, and either pilot can operate the controls.

3 SN10 Flight Pages – Competition Mode

To learn about club mode, please [skip to the Club Mode chapter](#).

In flight, you will regularly use the status, moving map, wind, and thermal heightband pages. You can also create your own custom page for use in flight. This section documents these as well as other pages available during flight.

The SN10 has “setup pages” for configuring the many available options, but these pages are hidden in “flight mode” ([for information on SN10 options, see the setup chapter](#)). The explanations below assume the Bayreuth, Germany site has been loaded and selected, GPS is operating, and typical American units are selected (distance in statute miles, speeds in knots, etc.). For the many options, default settings are assumed.

This chapter describes the SN10 features for the ‘classic’ task, where you fly to previously determined turnpoints. [Additional functions for the Assigned Area Task \(AAT, also called TAT or Turn Area Task in some countries\) are explained in a separate chapter.](#)

3.1 Task Page

Use the task page to plan a task before the flight, or during the flight if you want to change the task or see the remaining distance or estimated-time-to-finish (ETF).

On the task page, you select the start point, the turnpoints, and the finish point of your task.

As you select points with the **VALUE** knob, you will see they are sorted in alphabetic order. If you have points whose names begin with numbers, these numbered points appear after all points whose names begin with alphabetic characters, and are sorted in correct numeric order. Press **HELP** for a turnpoint's detailed description from the database.

Read the task page left column top-to-bottom, then right column top-to-bottom. The start point is at the top left (Bayreuth), followed by up to 10 turnpoints (Erbendorf, Weiden, then Zell Haidberg), and finally the finish point (again Bayreuth). At MacCready 2 (MC), the estimated time to finish the task (ETF) is 1 hour and 37 minutes. At the lower right is the total task distance of 80.5 miles. "Rema" gives time remaining for a time-limited task.

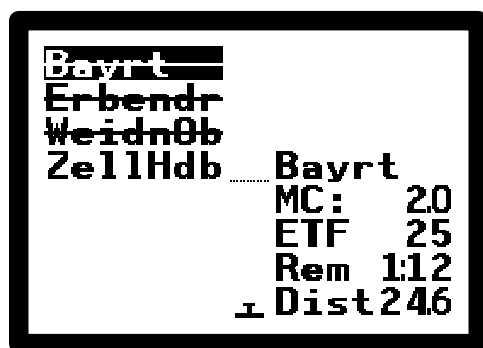
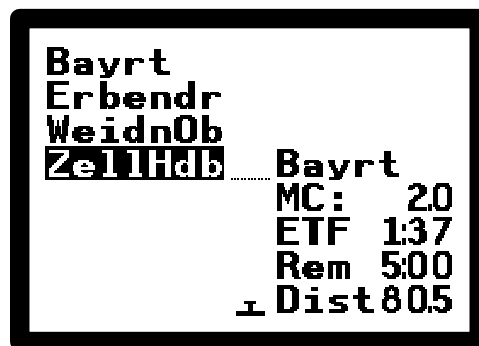

When you start, the start point is automatically crossed off (a line is drawn through the name). As you fly the task, each turnpoint you achieve is automatically crossed off; the picture at left shows you during a task after achieving Weiden and enroute to Zell. Finally, when you finish the task, the finish point is crossed off. [See the Task Rules page to learn about automatic start, turnpoint, and finish.](#)

During the flight, the SN10 will continually display both distance and time to complete the task. For many tasks, you may never use the task page in flight. For tasks determined during flight, you can add additional turnpoints, or change turnpoints you haven't yet reached. To help plan time-limited tasks, the remaining time counts down after the start, so you can compare your remaining time against the estimated time to finish the task (ETF).

In the middle of the task page is a glideslope indicator. When the small glider symbol rises above the dotted line, you are above the calculated final glide altitude. The glideslope indicator is also displayed on the status page.

The ETF is based on MacCready theory. In conditions with streeting or where you can climb flying straight, you should beat this estimate. ETF takes into account your current water ballast, bugs, and the effect of wind on remaining legs. Try switching to the status page, change the water or bugs, then switch back to the task page to see the revised ETF. As ETF takes into account your current altitude, the ETF on the ground will include

the time to climb to altitude, and will therefore be higher than if you look at this at start altitude.

Below ETF is the Remaining Task Time, for those tasks where the time on task is limited (1:12 in the illustration above). Optimize your pilot-selected task by trying different turnpoint options and comparing the ETF to the remaining time available for the task. [See the Timer Page](#) for more information on the PST timer function.

NOTE

- You can manually start the task by placing the cursor on the start point (upper left) and pressing the **ENTER** button. You'll see the start point crossed off, which confirms the task is started. If you use an automatic start option, you won't need to do this.
- After you have started the task, you can reset to 'before task start' by placing the cursor on the start point (upper left) and pressing the **ENTER** button. You'll see the line through the start point disappear. No line through the start point means the task isn't started.
- You can tell the SN10 you have reached a turnpoint by placing the cursor on the turnpoint and pressing the **ENTER** button, and you can toggle the turnpoint back to the 'unachieved' state by pressing the **ENTER** button again. You'll see the line through the point appear and disappear as you toggle its state. If you use the SN-10 automatic turnpoint notification, you won't need to do this.
- You can place blank entries between your turnpoints to make the task easier to read, or leave a space where you might add an intermediate turnpoint. Blank turnpoint entries are simply ignored by the SN10.
- Once a point is marked 'achieved' (crossed off as explained above), you cannot change this point or any task entry before this point. You can still change the portion of the task you have yet to fly.
- When you use the [Go Direct to Alternate](#) feature, any points you have achieved are preserved, but the unachieved part of the task is deleted. Instead, you will see a point called **AbortPt** inserted and marked achieved (**AbortPt** marks the point at which you abandoned your task), and the finish point will be changed to the alternate landing field you have selected. If you use the *Restore Task* feature after diverting towards an alternate, your task will be restored as it was.
- In competition, only points designated as *turnpoints* in the database are available as turnpoints for your task. If you select the "Touring" option all airports are also available as turnpoints ([see Competition or Touring option](#)).

3.2 Status Page

The status page displays all navigation information, final glide settings, and final glide status. This page is used often during flight. If you create a custom page, you will still use the status page for final glide settings.

The picture at right is what you might see enroute to Erbendorf. The fields shown are:

Avg -5.3	MC 20
Erbendorf	Water 40
Out 20.4	Bugs 0%
Left 0.6	Wind 270
◀118	at 5
Q 29.92	Alt 2812
131° at 81	Fin 2083
STI 34:45	---9908

Avg -5.3 – 20 second Total-Energy-Average ([see the Selectable Average section below](#) for an explanation of how to select an alternate averager presentation).

Next Point (start, turn, or finish point) – In this illustration, your next point is **Erbendorf**. If you are not using automatic start and turnpoint notification, you can place the cursor on this field and press **ENTER** to mark the point as achieved and move on to the next task leg.

Out, Left/Right – Distance to the next point, and distance left or right of the course-line.

Bearing 118 – Erbendorf is compass bearing 118 degrees from your current location. The arrow shows you need to turn left in order to track directly towards Erbendorf. The arrow grows and shrinks depending on how much you need to turn.

Q 29.92 altimeter setting, inches of mercury.

131° at 81 – Your current GPS ground track is 131° at 81 knots.

STI 34:45 – Your start-time-interval timer has counted down to 34 minutes 45 seconds. [See the Timer Page](#) for more information on the STI function.

MC 2.0 – MacCready setting of 2.0 knots.

Water 40 – 40 gallons of water on board.

Bugs 0% - The percent degradation of your max L/D is 0% (no bugs or rain).

Wind 270 at 5 – You have entered a wind strength of 5 knots from 270° true (not magnetic). Please note wind speed and direction is not set automatically; you must make a judgment about the wind you expect to encounter on final glide. You can simply copy the measured wind from the wind page to this final glide wind by placing the cursor on the measured wind at the top of the wind page and pressing **ENTER** ([see the wind page section below for more details](#)).

QNH 29.92, Alt 2812 – Current altimeter setting and altitude. Just like your mechanical altimeter, changing either QNH or altitude changes the other automatically.

Fin 2083 – Finish altitude; MSL altitude desired at the finish, including your safety reserve (field elevation plus safety reserve). Whenever you change the finish point, the SN10 resets this finish altitude to the new finish point's elevation from the database plus 150 meters (approximately 500 feet). If you select a finish point which has no elevation in the database, you must set this manually. Adjust this value to adjust your safety reserve.

---9908 – You are 9908 feet below the calculated final glide (you will see **++++200** when you are 200 feet above final glide). This is called your altitude surplus or deficit, and is continually recalculated as you fly around the task. It is also total-energy compensated, so as you slow down and speed up the number does not change. When you start the task, this will be a very large number, but as you near the end of the task you will use this number to see how much altitude you need to climb to finish the task.

3.3 Thermal Heightband Page (optional)

The thermal heightband page helps you easily see when it is time to leave a thermal, how the current thermal compares to the previous two climbs, what climb rate you are really achieving, and helps to optimize the heightband to fly.

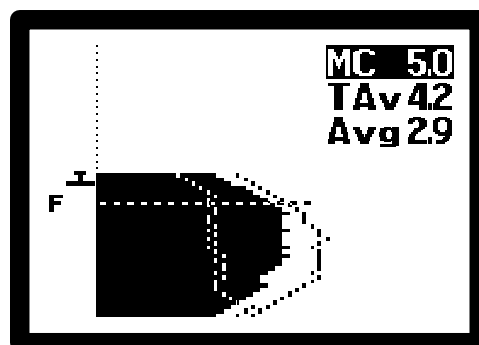

The graph shows your climb rate throughout a climb. The vertical axis of the graph is altitude, with the glider symbol on the left showing your current altitude within the depicted heightband. The climb rate is the horizontal axis. As you climb, the SN10 paints a solid graph showing the climb rate at increasing altitude. You can see the climb rate increases as the thermal is centered, then eventually decreases near the top of the thermal, showing the pilot has stayed after the thermal has become weaker.

The dotted lines show the outlines of the two previous thermals, so you can see how the current thermal compares to the previous thermals in strength and heightband. When you are near final glide altitude, the dashed line (**F- - -**) appears to show the final glide altitude required. In the illustration, you can see you are above MC 5.0 final glide. (The glider symbol is above the final glide height). Always double-check the wind, bugs, water, and altimeter settings before leaving that last thermal on final glide !

Also on the thermal heightband page is the Thermal Average **TAv**, which helps you decide on an appropriate MC setting. TAv is the average for the entire thermal (starting when you switch into climb mode, until you leave the thermal and switch back to cruise). TAv is continually updated while climbing. When you leave the thermal, TAv continues to show the overall average climb rate of the last thermal, and is not changed or reset until you enter another thermal.

The averager (**Avg 0.0**) is normally the standard 20-second average of total energy, but you can [select an alternate average display](#) if you prefer.

3.4 Moving Map Page

The SN10 moving map shows the task and airspace boundaries, and optionally landing points with final glide. In order to display airspace boundaries, the airspace information must be loaded with an SN10 database for the currently selected site ([see *Preparing Map Data For Use With The SN10*](#)).

In the illustration at right, you can see the airspace around Bayreuth and a sample task. The airspace (bounded by solid lines) shows the corner of the Nuremberg airspace in the lower left, and the Grafenwöhr US army airspace bottom center. The task (heavy line and dotted lines) has been selected to avoid the restricted area. The heavy line is the current leg.

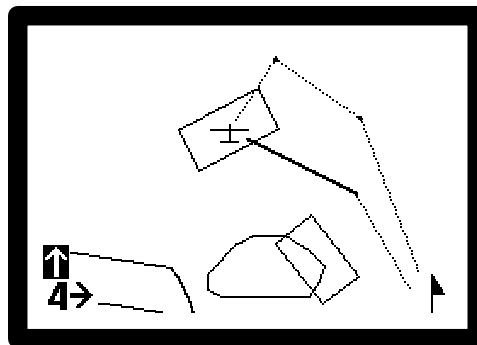

You can use the moving map either North-Up or Nose-Up. North-Up shows the map with North at the top, the North arrow in the lower right always points up, and the glider rotates in the center of the screen to show the current flight direction. Nose-Up rotates the map to match what you see out the canopy, the glider is fixed at the bottom of the screen, and the North arrow in the lower right rotates to point North. The Nose-Up map orientation matches your view and not your ground track (the SN10 automatically compensates for any crab angle, unlike most moving maps). Press **ENTER** to toggle the moving map between North-Up and Nose-Up presentations (this resets any scrolling).

The lower left of the screen has controls for scale (zoom) and for scrolling. You can scroll the map up and down by placing the cursor as shown in the illustration above and changing **VALUE**, or scroll left and right by placing the cursor on the other arrow and changing **VALUE**. Press **ENTER** to reset the map position after scrolling the map (pressing **ENTER** also toggles between North-Up and Nose-Up).

Depending on the [settings on the Task Rules page](#), the moving map can also display:

- The task start line, FAI start sector, or start cylinder,
- Turnpoint cylinders or FAI turnpoint sectors, and
- The finish line, FAI sector, or cylinder.

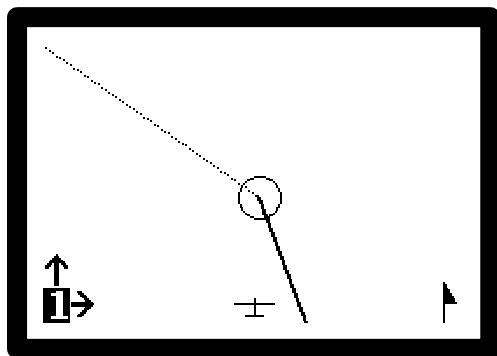

This illustration shows the turnpoint cylinder you would see approaching a turnpoint from the south, with the moving map displaying Nose-Up. The heavy line is your current task leg, and the dotted line is the next leg. The glider is left of the course line.

3.4.1 Alternate Landing Points on the Moving Map Page

The SN10 optionally displays alternate landing points on the moving map, along with glideslope information for final glide to a selected alternate. Enable map alternates by checking **MapAlt** on the [SN10 Options 1](#) page, and the SN10 will show landing points on the moving map as follows:

- The closest 5 landing points are displayed on the moving map (only if they are within the area currently displayed on-screen).
- A "+" symbol marks an alternate in range, "-" marks an alternate out of range, and "u" marks an alternate whose elevation is not known (possibly the last location the [GPS Mark Location](#) was used, which might not be a landing field).
- The number at the top left of the screen selects an alternate. Set this number to "0" to use the moving map as normal. Change this number to 1 to select the closest alternate, 2 the next closest, up to 5 for the 5th closest.
- When an alternate is selected (the alternate number is set from 1 to 5 at top left):
 - A thick solid line is drawn from the glider to the alternate, and the current task legs are drawn as a thin dotted line.
 - The selected alternate's name is displayed at the top of the screen.
 - The altitude above or below glideslope to the selected alternate is displayed at top right of the map.
 - Press **HELP** with the cursor on any of the fields at the top of the screen to display the description of the selected alternate (after the field help screen).
 - Press **ENTER** with the cursor on any of the fields at the top of the screen to reset the task to go directly to the alternate (just like the [Alternates Page](#)).
 - The glideslope to the selected alternate is calculated identically to the [Alternates Page](#), using the current wind, MC setting, an arrival altitude of 500 feet (150 meters) AGL, etc.

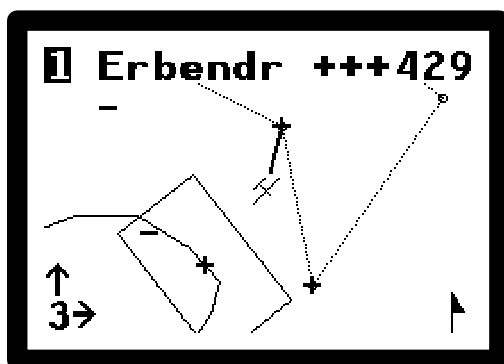

At left, the closest alternate **Erbendorf** has been selected (number **1** at top left). The pilot is **+++429** above glideslope. Erbendorf is a bit behind the glider, a solid line shows the route to Erbendorf, and the task is displayed with dotted lines. Two other alternates are within reach (marked by "+" symbols), and a further two alternates are beyond reach ("- symbols).

WARNING

Alternates on the moving map are handled identically to the Alternates page, and subject to the same limitations and hazards. For your safety, make sure to study the [Alternates Page](#) below prior to using this feature.

3.5 Measured Wind Page

The SN10 measures the wind with extraordinary accuracy, and displays this measurement on the wind page. Along with the current measurement, you will see an arrow showing the wind with respect to your current heading (like a wind sock), the certainty of the measurement, and the instantaneous headwind or tailwind. In the lower part of the screen, the wind is recorded at different altitudes you have flown. The wind measurement is updated continuously. Unlike many other flight computers, circling is not required for wind measurement.

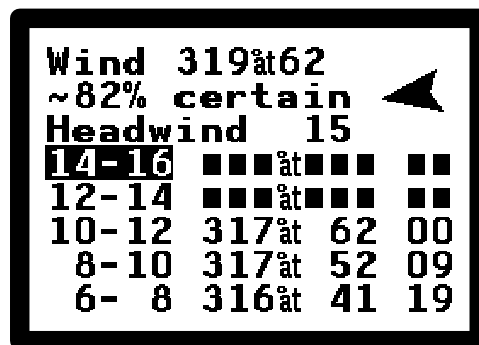

The illustration shows the wind measurement during a wave flight in very strong winds. The wind is currently from 319 degrees true at 62 knots. The wind is now almost off the right wingtip, so the instantaneous headwind is just 15 knots. The average in the 10,000 to 12,000 foot altitude band is from 317 degrees true at 62 knots, and the data for this altitude band was last updated 00 minutes ago. The information about the 8,000 to 10,000 foot altitude band is now 09 minutes old.

To see additional higher or lower altitude bands, place the cursor on any of the band fields (as shown in the illustration) and change **VALUE**.

WARNING	<p>The measured wind <u>may not</u> be the same as the wind setting you want for the final glide calculation.</p> <p>The measured wind is what was behind you; the wind needed for calculating your final glide is what you judge will be the wind ahead. For example, if you see a measured tailwind of 30 knots at 17,000 feet, it would be a very bad idea to assume this tailwind will continue all the way to the ground. In the mountains, you will often encounter a tailwind in one valley and a headwind in the next. Sometimes, you must final glide through small frontal effects, like a sea-breeze front or afternoon Westerlies from the Sierra at Minden. You must judge what you will encounter ahead, and set the SN10 accordingly.</p> <p>The SN10 cannot measure the wind ahead.</p> <p>The SN10 wind measurement is an <u>estimate</u>, not an exact measurement. You must judge if the wind is appropriate, and increase your safety margins if the SN10 displays low certainty in the wind measurement.</p>
----------------	--

To set the final glide wind to the current measured wind, place the cursor on either the measured wind direction or strength, and press **ENTER**. Use this shortcut when you are sure the measured wind is a realistic estimate of what's ahead.

NOTE

- This measured wind page is not available if the GPS isn't working.
- The wind measurement system relies on correct functioning of your pitot, static and temperature probes.
- If you do aerobatics, or steep dives, the wind measurement system may display erroneous measurements.

3.6 Alternates Page

The *Alternates* page helps you select an alternate landing field and plan a final glide to this field. It is very useful when you are unable to complete a task and need to find a safe place to land. The SN10 shows final glide information to two independent choices, so you can easily cycle from one alternate to the next when crossing hostile terrain. Alternates are ordered by distance, with #1 the closest landing field.

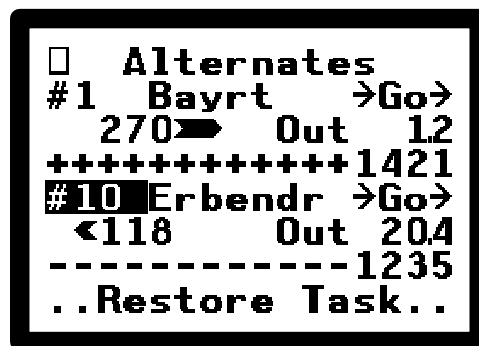

In the illustration, the first (closest) alternate is Bayreuth. Bayreuth is at bearing 270, 1.2 miles away. The arrow next to 270 shows you need to turn right in order to track towards Bayreuth. You are 1421 feet above final glide altitude, calculated with an arrival altitude of 500 feet (150 meters) AGL. The final glide altitude is calculated using the wind you have set for final glide, using the current MacCready setting, bugs, water, and altimeter setting, and using the field elevation for Bayreuth from the database.

To find the closest landing field, place the cursor on the # field and spin **VALUE** rapidly counter-clockwise to get to choice #1. You can also choose a specific alternate by name; just place the cursor on the point name and change **VALUE** (just like choosing a turnpoint of the task).



If you wish to see additional information about an alternate, place the cursor on the alternate name and press **HELP**. The illustration at left shows us **Erbendr** is an abbreviation for the Erbendorf-Schweis gliding field, elevation 1,624 feet, radio frequency 123.350. No field length is given, but we can see it's marked in the database as an airport (A), a task turnpoint (T), and most importantly that it's a good landing field (L). See [The SN10 Database](#) for more information about point data.

To Go Direct to an alternate, place the cursor on **→Go→** and press **ENTER** to change your task to fly direct to the alternate. This will:

- Remove any points you have not yet achieved from the task,
- Record the point at which you abort the task as the point **AbortPt**,
- Place **AbortPt** as the last achieved point of the task,
- Reset the task finish point to the selected alternate,
- Reset the task finish altitude to the alternate elevation plus 500 feet,
- Draw the course line from the current position (**AbortPt**) to the alternate on the moving map, and

- Enable the Restore Task button at the bottom of the Alternates page.

If you find lift and wish to restore your task as it was before you used the Go Direct feature, place the cursor on **Restore Task** and press **ENTER**.

WARNING	<p>The landing point displayed by the SN10 may not be a safe place to land. You must be careful your SN10 database has current data. Airports become unlandable, farm fields entered as landing point may have high crops, and sometimes errors are made in entering coordinates or elevation into the database. Don't final glide to a point unless you are sure the coordinates and elevation are correct and it's currently a safe landing spot. We have heard about a pilot who final-glided to a heliport (accidentally entered in the database), and another who final-glided to a closed airport.</p> <p>There may be an obstacle between you and the landing point. The SN10 does not know about hills, mountains, and obstacles between you and the alternate landing point. Double-check with a current map. A famous pilot we know tried to final glide through a mountain (it didn't work).</p> <p>The GPSmark point in the database is marked wherever you last pressed Mark Position – which might not be a landing field. If you marked the position of a thermal, don't use GPSmark as an alternate !</p>
----------------	---

NOTE

- Only points marked *Landing* in the database will be displayed here. See [The SN10 Database](#) for more information.
- If you press *Go Direct* and then you edit the task, *Restore Task* will be disabled.
- If you select a point for which elevation was not provided in the database, the SN10 will show you arrival altitude MSL instead of altitude above or below glideslope. In this case, you must check the elevation from a map to see if this is a safe alternate.
- In the top left corner of the Alternates page, you will see a small *GPS blinker* that shows whether the GPS is operating properly. Normally, the blinker alternates between an empty box symbol and a small N (Navigating). If the GPS is not navigating, you will see a blinking question mark **?** as the GPS tries to find its position. If the GPS is not connected, you will see a small 'broken connection' symbol.

3.7 GPS Page

The GPS page displays current GPS information, and allows you to mark a point and then navigate back to this point. Use the Mark Position feature to mark a thermal, a landing field, or a strong point in a wave. This page is infrequently used during flight.

Place the cursor on **Mark Position** and press **ENTER** to mark your position. This saves your current position as the point **GPSmark** in the database, and then shows you the distance out and bearing back to this point. The illustration shows you 2.6 miles out from the point you marked, and you need to turn right slightly to track 269 degrees back to the point.

```

GPS:  NMEA Input
--Last-GPS-Fix--
N 3D  Accur:  2
Lat:    4407:30N
Long:   7247:00W
Age Of Fix: 00:00
-Mark-Position-
Out  26    269>

```

WARNING

The **GPSmark** point is marked in the database as a **landing point**. Thus, you can use this **Mark Position** to remember the location of a landing field. However, if you use **Mark Position** to mark a thermal, remember not to use this point as a landing field on the Alternates or Moving Map pages.

When the GPS is operating normally, the small **N** blinks (we call this the *GPS blinker*). If the GPS is searching but not yet navigating, you will see a blinking **?**. If no signal is received from the GPS engine (no power, not plugged in, etc.) you will see a 'broken line' symbol here.

If no input is received from the GPS, the SN10 will give you an alert message suggesting you check the GPS connection; usually this happens when you forget to plug in the flight recorder. If the GPS is communicating with the SN10 but is unable to find your position, you will receive an alert that the GPS is not navigating.

If your GPS fails, you can select **GPS: Off** at the top of this page, and use the SN10 in dead-reckoning mode (see the Appendix [Using the SN10 without GPS](#) below).

Many GPS units do not provide the number of satellites used or accuracy measurements. In this case, you will see **Accur:■■■** instead of a measure of the current GPS position accuracy.

3.8 Timer Page

The *Timer* page shows the start time interval and Pilot-Selected-Task (PST) count-down timers, time of your most recent start of task, and current date and time. Place the cursor on **START** or **FINISH** and press **ENTER** to start or finish the task (you can also do this on the task page). This page is available but infrequently used during flight.

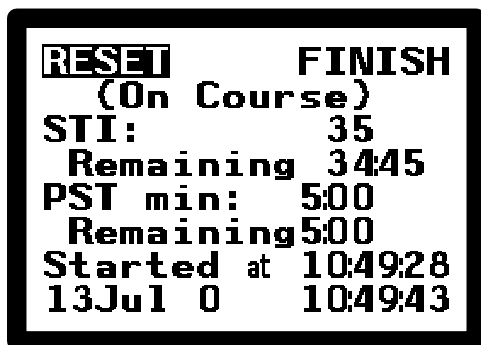

After a start, the timer page is updated to show the time of your most recent start (left). Also, the **START** field changes to **RESET**. Place the cursor on **RESET** and press **ENTER** to reset back into the *Before Start* state and prepare for another start (this is just the same as placing the cursor in the start point on the task page and pressing **ENTER**).

STI (Start Time Interval) is used in some countries to control the time between your take-off and your first start, and then between subsequent starts. If you do not need the STI timer, disable this feature by setting STI to 0:00 on this page.

The STI (start time interval) time remaining starts counting down at take-off. When there are only 10 minutes remaining in the STI, the SN10 will give an alert message.

The PST (Pilot Selected Task) timer is used in some countries for time-limited tasks. After you start the task, the PST time remaining counts down. PST time remaining is also displayed on the task page next to the estimated-time-to-finish (ETF), to help optimize this type of task.

3.9 Flight Summary Page

The SN10 shows distance (flown and to go), time and average speed on task, and climb statistics (percentage of time climbing, average climb rate, and time climbing). To change the display units for average speed, place the cursor on the units field (**fts** at right) and change **VALUE** (this is helpful when you fly at contests where speed is measured in units different from your usual settings). This page is available but infrequently used during flight.

Flight Summary	
Dist To Go	160
Dist Flown	759
Elapsed	51
00% Climb	00
In flight	53
Speed	775 kts
Avg climb	00

3.10 L/D Calculator Page (optional)

The L/D page shows you the glider performance for the current polar and MC, including L/D, estimated cross-country speed, and still-air speed to fly. While this page is infrequently used in flight, you can use it to check if the MC setting matches the desired cruise speed (useful if you fly using a modified single-speed strategy).

L/D Calculator	
MC:	25
Water:	90
L/D:	290
Est speed:	119
S to Fly:	186
+++++2035	

3.11 Vario Tuning Page

You can change the SN10 variometer scale, variometer response characteristics, and audio deadband width on the *Vario Tuning* page.

The audio deadband is the range about the optimum cruise speed where the speed-to-fly audio command is silent. The variometer speed should normally be set to *Filtered*, for ILEC’s specially filtered response.

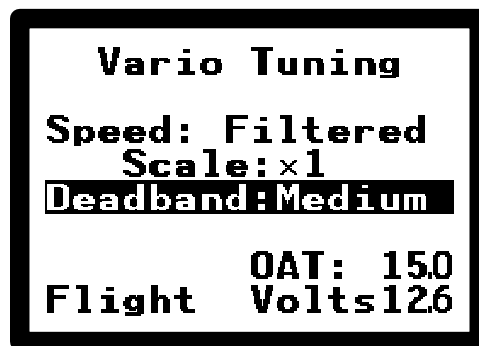

Details about the variometer speed (response characteristic) setting:

Variometer Speed	Function
Filtered	Recommended setting gives you a vario that is fast, but not too nervous in its response. This uses digital signal processing to produce a nominal response time of 1 second, but with additional filtering to reduce the effects of gusts. Note: we recommend no pneumatic gust filters be used with ILEC variometers !
Extra Slow	In extremely rough conditions, or to offset the effects of a poor total energy system, the Extra Slow setting gives a nominal response time of 3 seconds.
Extra Fast	Normally not recommended; only for use in conjunction with a pneumatic gust filter (which we recommend against).

The variometer scale (sensitivity) functions as follows (please note the audio tone continues to increase even when the meter is at the stop):

Variometer Scale	A Full-Scale Meter Deflection Indicates...		
	Meters/Second	Knots	Feet/Minute
1	± 5 mps	± 10 kts	± 1,000 fpm
2	± 10 mps	± 20 kts	± 2,000 fpm
0.5	± 2.5 mps	± 5 kts	± 500 fpm
0.25	± 1.25 mps	± 2.5 kts	± 250 fpm

At the bottom of the Vario Tuning page, you can see the current **OAT** (outside air temperature) and **Volts** (battery voltage).

Flight disables display of the SN10 setup pages (flight mode). Place the cursor on this field and change **VALUE** to enable display of the setup pages (you’ll see **Setup** displayed instead of **Flight**).

3.12 Simple Final Glide Page (optional)

This page gives you a very simple old-style final glide computer. Use this calculator if you want to do a quick final glide calculation without GPS, without using the task, and without using the *Alternates* page. Using this page, you can also get a headwind or tailwind estimation without GPS. This page is available but rarely used in flight.

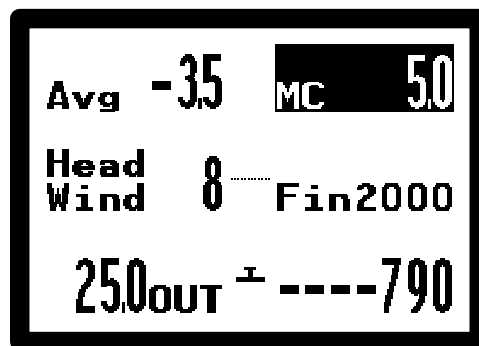

Follow these steps to use this simple calculator:

- Verify the altimeter setting (on the status page).
- Set your desired finish altitude to the altitude at which you wish to finish the final glide (field + reserve), for example **Fin2000** to arrive 1000 feet over an airfield at elevation 1000 ft.
- Dial in the distance **Out** and press **ENTER** with the cursor still on the distance. Pressing **ENTER** tells the SN10 to interpret the distance as an exact position fix, and restarts the simple final glide page wind calculation and distance count-down from this point.
- Set the headwind or tailwind based on your best estimate.
- As you progress along the final glide, the SN10 will count down the simple calculator distance **Out**, based on the airspeed and the headwind or tailwind you entered here. It will stop counting and assume the sailplane is drifting with the wind when switched into CLIMB mode, and resume counting when switched back to CRUISE. (Switching between CRUISE and CLIMB is performed either automatically or by external switch, depending on [the Cruise/Climb Switching option](#)).
- During final glide, adjust the wind until the distance shown matches your actual distance out. If you think the headwind or tailwind the SN10 has calculated is incorrect, reset the distance, press **ENTER** with the cursor on the distance to again fix your position, and change the wind to your best estimate.
- Changing the headwind/tailwind will cause the SN10 to adjust the distance to match, but changing the distance does not alter the wind estimate.
- The surplus or deficit **----790** is a *total energy glideslope*. This means in still air, pull-ups or pushovers will not affect the surplus or deficit. This is computed for completion of the final glide at the selected finish altitude, with the expected still air cruise airspeed for the selected MacCready setting, and with the selected bugs, water and polar.

- For example, in still air, flying slower than speed to fly for the selected MacCready speed will result in a gradual decrease of the altitude deficit, plus a *speed-up* indication from the speed to fly variometer and audio.
- Remember, while the headwind/tailwind and distance of the simple final glide calculator is independent of any task you have selected, the values for MC, water, bugs and altimeter setting are shared with the rest of the SN10 and should be verified on the status page.

Always check the SN10 altimeter setting, bugs, and water before starting a final glide !

3.13 Custom Page (optional)

You can optionally create your own *Custom* page to display the information you feel is most important for the manner which you fly with a screen layout you choose. If enabled, the *Custom* page is the first page in flight mode (spin the PAGE knob counter-clockwise to get to the custom page). You can display fields in double-height, choose a ¼ screen block of wind information, and choose the center graphic to suit your taste.

Illustrated below is the SN10 default layout for the *Custom* page:

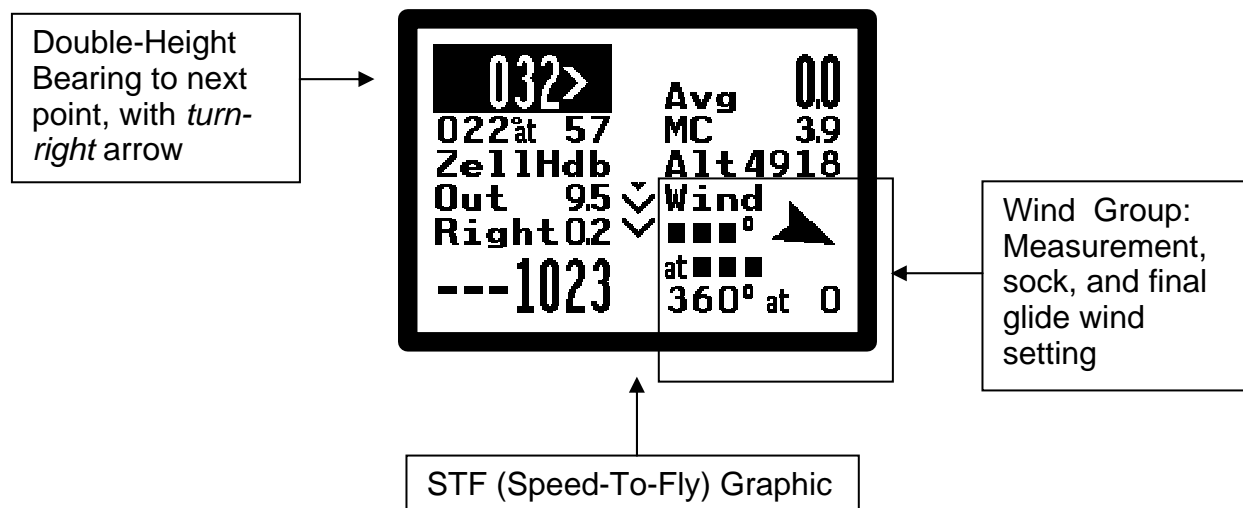

Enable the *Custom* page on the [Options 2 setup page](#). See [Customizing the Custom Page](#) for an explanation of how to configure the *Custom* page.

4 The SN10 Database

An SN10 database contains a list of points (turnpoints, landing points, etc.) and, optionally, airspace data for a geographic area. Typically, a database is created for a specific contest site or a small region (though a database can encompass all of Germany for example). For many sites around the world, databases are already prepared and available on the Internet, and most pilots use these pre-prepared databases.

You must load a database from your PC into the SN10 for the SN10 to operate properly. You can add or change turnpoint or landing points on the SN10, but this feature is only for last minute corrections or additions to a database loaded from your PC. The SN10 holds two databases, normally used for your home site and another site you visit. Select which site (which of the two databases held by the SN10) you would like to use on [the Site page](#).

The capacity of the SN10 database is up to 900 points (site #2) or 600 points (site #1), minus the space used for airspace data. This is more than adequate capacity. For example, the database for the WGC99 world championships contained 130 contest points, 300 landing fields, and the airspace data for the entire contest area including the Czech Republic (the airspace data consumed the same space as about 70 points).

This chapter explains what the database contains and how it is used in the SN10. For further information about database preparation, and information about how to load a database from the PC into your SN10, see [Using the SN10 with Your PC](#) below.

Whenever you place the cursor on a field displaying a point and press/release **HELP**, the SN10 displays the following detailed information about the point. Each of these pieces of information is explained in depth below.



4.1 Types of Points (Point Attribute Codes)

Points in your database include primarily turnpoints and landing points. It is very important to properly classify points in the database for correct operation of your SN10 ! Each point is classified with at least one and often several of following attributes (characteristics), displayed with summary codes in the **HELP** text for the point:

Code	Full Description and Function
T	Turnpoint. This point will appear in the list of available turnpoints on the task page.
L	Landable. A safe landing field. This point will appear in the list of alternates (on the <i>Alternates</i> page), and also as a possible choice in the Finish Point of the task page. Points not marked Landable will not appear on the <i>Alternates</i> page or as alternates on the moving map !
A	Airport. It may be an airport that is unsafe for landing because its too narrow, closed, or for helicopters only. This attribute does <u>not</u> cause a point to appear in the list of alternates. If you wish a point to appear as a possible landing point on the Alternates page, you must also set the "Landable" attribute. If <i>Touring</i> is selected, this point will also appear as an available choice for a task turnpoint (see Touring vs. Competition).
S	Start Point. This point will appear as a possible choice for the Start Point of the task.
F	Finish Point. This point will appear as a possible choice for the Finish Point of the task.
M	A point of interest, where perhaps no further information is available.

4.2 Point Short Names and Order of Point Display

The SN10 refers to points using a seven-character name. Preparing a database requires choosing this short name with care, so you can quickly find it in the alphabetically ordered list of points.

Many contests provide a numbered set of turnpoints. The SN10 sorts all points whose short name begins with a number together, after all the names that start with an alphabetic character. The numbers are sorted properly, for example ordered like:

- Alpha
- ... (names starting with alphabetic characters)
- Zulu
- 1StartN
- ... (any names starting with the numbers 2 through 9, in order)
- 10BigCu
- ... (any name starting with the numbers 10 through 19, in order)
- 20Cloud9

Names can also contain a limited number of non-English characters, in particular characters with accents. These sort next to the character without the accent.

4.3 Point Elevation

If possible, the point elevation should be provided in the database. The SN10 will work fine if the elevation is missing from a point, but you won't get automatic setting of the arrival altitude **FIN** when you set this as a new finish point, and the *Alternates* page will give an MSL arrival altitude instead of amount above or below glideslope.

4.4 Point 5-Line Description

When a database is prepared, descriptive information of up to 5 lines (16 characters each) can be provided for each point. This is typically used to include the full name of the point without abbreviation, radio frequencies, and runway information.

4.5 Airport Identifier (ICAO code)

This is provided for future interoperability with GPS products which use the ICAO airport identifier. At present the airport identifier is just displayed for your reference.

4.6 SN10-Generated Points

The SN10 creates database entries to mark points whose position is set during flight:

- **GPSmark** – Set to the location where you last pressed **Mark-Position** on the *GPS* page. This point is marked by default as a landing point.
- **AbortPt** – Set to the location where you last aborted a task to go direct to an alternate, either on the *Alternates* page or using the Map Alternates feature.
- **AAT PTn** – Set to the position where you confirm that you have turned in an assigned area task.

4.7 Special Notes on Points Edited at SN10

When you edit a point directly on the SN10, this point will become visible in both sites. Edited points, or points created by the SN10 (see above), are marked with a * in the upper right corner of the point information help page shown above and the *Point Edit* page. To clear all points created directly at the SN10 and “undo” all point edits, use the **SN10 Point Edits** reset field on the *SN10 Resets* page.

5 Configuring the SN10 (Setup Pages)

SN10 *Setup* pages are normally hidden, as you don't want to see all these pages during flight. To display the *Setup* pages, turn to the Vario Tuning page, place the cursor on **Flight** at the lower left, and adjust **VALUE** (you'll see **Setup** displayed).

The SN10 has a large number of options, in order to accommodate different pilot preferences, different kinds of flying, and the different competition and badge flight rules around the world. Please spend a few minutes reviewing these options, to ensure the SN10 is configured to best meet your needs.

5.1 Audio Setup

We strongly recommend you use the SN10 Standard audio, which has been developed after many years of research and testing. If you are used to the sound of a different instrument, please try the SN10 Standard setting for several flights before you change it !



In climb, the SN10 standard audio makes a nice warble sound increasing both pitch and warble rate with climb. It becomes a sad solid tone decreasing in pitch as climb drops below zero. In cruise the audio gives speed-to-fly; an interrupted tone means slow up, quiet means you're flying at about the correct speed, and a solid tone means speed up.

Change the audio selection by placing the cursor on the 4-line field as shown, and adjusting **VALUE**. The different sounds are described with each choice.

There are two categories of audio: switched and un-switched. The switched audio behaves differently depending on whether you are in cruise or climb mode. This provides a larger possible range of sounds in each mode, without confusion. Un-switched audios provide a climb tone when you are climbing, and a speed-to-fly signal otherwise. Some pilots are used to older un-switched audios, but in some flight speeds these can be confusing. Also, un-switched audios can be extremely irritating in rough thermals, because you will get a *speed-up alarm* sound each time you hit sink at the edge of the thermal.

Volume Coefficient: If you have a noisy glider at high speed, you can tell the SN10 to automatically increase the audio volume as airspeed increases. Set 0 for no increase in volume with airspeed, up to 10 for the maximum increase with speed.

Lift Alert: The SN10 will make a short beep-beep-beep if you cruise through lift strong enough that it might be worth circling. This determination is made based on your current MacCready setting. Set Lift Alert On if you want this sound.

Note: The audio is not affected by the variometer settings.

5.2 Variometer Setup

On the variometer page, you control what kind of vario presentation the SN10 will show on the analog vario meters, and also what digital averages will be given on the status and other SN10 pages. Choose separately what you want to see in cruise and in climb.

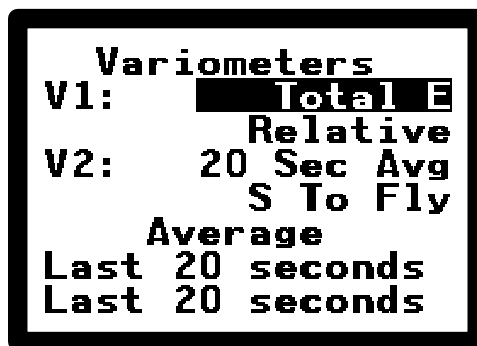

5.2.1 Variometer Choices

The V1 settings control the primary (number one) meter attached to your SN10. Set the vario indication you wish to see on V1 in climb (normally total energy), and below this what you wish to see during cruise. The V2 settings control the optional second meter.

Variometer	Full Description and Function
Total Energy	The climb rate as indicated from your total energy probe. You should normally set your primary meter to Total Energy for climb.
Relative	For use in cruise only, estimates the climb rate you would achieve if you were to stop and circle at this instant. Many pilots like this, as it eases decisions about when to stop and thermal.
Netto	Netto estimates the air mass movement, regardless of the sailplane speed. Extremely useful in cruise, as you can see what the air you are flying through is really doing. It answers questions like "Am I flying in a lift street?" or "Where is this wave?". Not appropriate for use in climb (except perhaps in wave).
S To Fly	Speed To Fly (STF). For use in cruise only, indicates whether you are flying at the correct speed. Note the audio also gives STF information.
20 Sec Avg	20 second TE averager value. Appropriate for use on second meter in climb.
20SecNetto	20 second average of Netto. Useful only as an air mass indication when cruising. Can be useful to see whether the ridge is really working.
ThermalAvg	Not recommended for meter display (thermal average).
20MinClimb	Not recommended (average of last 20 minutes of climb).
PerfIndex	Not recommended for meter display (performance index as below, 100% displays 0 on the meter, 200% deflects the meter full up, 0% deflects the meter full down).
FinalGlide	Not recommended (above or below final glide, 200 meters gives full meter deflection).

5.2.2 Selectable Averager Choices

Many SN10 pages display the selectable average, including the *Status* page, the *Thermal Heightband* page, and optionally the *Custom* page. On the Variometers page, you specify which average you would like displayed during climb, and separately, which average you would like displayed during cruise. By default, the SN10 shows the 20 second Total-Energy average for both cruise and climb. You can choose any of the following settings:

Selectable Average	Full Description and Function
Last 20 seconds	The classic 20-second average of your total-energy vario.
Performance	<p>For use in cruise, an index of how you're doing compared to the expected glider performance. This is helpful in optimizing cruise, and also planning final glide (don't cut it close if you've only been getting 80% all day!). For example, if the performance index shows...</p> <ul style="list-style-type: none"> 100% you have encountered no lift or sink during cruise, and the glider is performing exactly according to the current polar (water, bugs). 90% you are achieving less than the expected performance, probably because you have cruised in sink, but possibly because your water is set too high or your bugs too low. 115% you are achieving better than expected performance, probably because you have cruised in lift, but possibly because you have set the bugs too pessimistically or set the water too low. <p>The performance index is reset to 100% each time you start cruising (that is, each time you switch from climb to cruise).</p>
Netto 20 sec	20-second average of Netto.
This Thermal	The average climb rate since the start of the current thermal, or if you're cruising the overall average climb rate of your last thermal (same as TAv on the thermal heightband page).
20 min climb	Average of the last 20 minutes during which you were in climb mode. Some pilots prefer this as an indication of how the day is progressing.

5.3 Units Setup

On the units page, set the units the SN10 will use for all display and entry. The different units choices and their uses are shown in the following table:

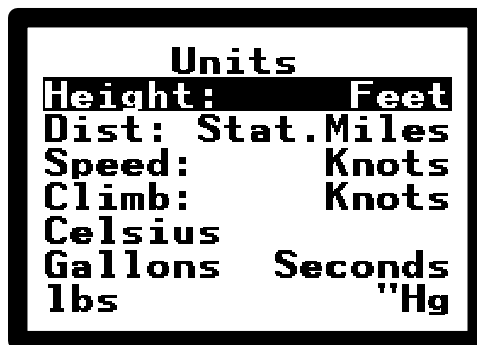

Units	Use	Choices
Height	Altitude, airport elevations, final glide surplus/deficit...	Meters or Feet. Note the extended help for Altitude gives indicated altitude in both feet and meters, to ease dealing with airspace restrictions when using mixed units.
Distance	All distances	Kilometers, Nautical Miles (1.852km), Statute Miles (1.609km).
Speed	All speeds except average speed on task (units for speed on task are set on the <i>Statistics</i> page)	Kilometers/hour (km/h), Miles/Hour (mph), Knots (kts).
Climb	Variometers, averagers...	Meters/Second (mps), Knots, hundreds of feet/minute (100 fpm).
Temperature	OAT	Fahrenheit or Celsius .
Water Capacity	Water ballast setting on cruise page, glider polar setup.	Gallons , Liters , lbs , or kg .
Latitude and Longitude	Coordinate display and entry (points, GPS), either using seconds or decimal fractions of minutes.	Seconds degrees:minutes:seconds 1/10's degrees:min.X tenths 1/100's degrees:min.XX hundredths 1/1000s degrees:min.XXX thousandths
Weight	Glider weight entry for polar	lbs , or kg .
Pressure	Altimeter setting	"Hg , mb , or hPa (inches of mercury, millibars, or hectopascals).

NOTE

- The units for speed units set on this page do not change the units in which average speed is displayed on the *Statistics* page (set on the *Statistics* page).

5.4 Site Select

Before your first flight with the SN10, you must load a database from a PC into your SN10. You cannot enter turnpoints into the SN10 without first loading a database. See [The SN10 Database](#) and [Using the SN10 with Your PC](#) for more information.

Select the active SN10 database on the *Site* page. This selected site will be used for all operations of the SN10, including loading a new site description from a PC. The text in the lower part of the screen is the description of the selected site, loaded from a PC.



Before you load a new site into the SN10, you must erase the current site here. Place the cursor on **Erase** and press **ENTER** to erase the selected site.

When you load or select a new site, the SN10 will include all points that have been edited at the SN10 in the site you have just selected. If you do not want these points included, delete all points you have edited from the SN10 as follows:

- turn to the *SN10 Resets* page,
- place the cursor on **SN10 Point Edits**, and
- press **ENTER** ([see Section 5.10.3 "Reset SN10 Point Edits"](#)).

You can adjust the average compass variation and the default home point on this page.

5.5 Point Edit

Use the Point Edit page to make last-minute corrections or additions to your database. Normally, you will prepare the database on a PC, but this page is great for when the contest organizers announce a small mistake in the coordinates just minutes before launch.

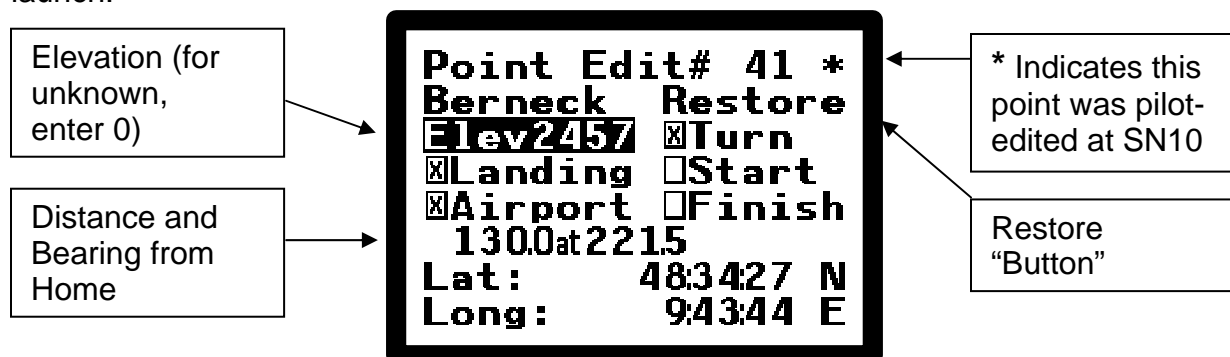

NOTE

- The number of the point (**41** in the picture) is just the number in which the point is sorted according to the sort rules described above under “SN10 database”. This number has nothing to do with any turnpoint numbering scheme ! If you change the name of a point on this screen, you may see the number change.
- The asterisk indicates this point was user-modified after it was entered into the SN-10 database from a PC.
- To enter a new point, place the cursor on the point number and spin **VALUE** clockwise past all of the entered points. The SN10 will show a blank point which you can fill in. Then, set the name, coordinates, and attributes.
- Points edited at the SN10 will be visible in both sites. For example, if you are using *Site #1* and you correct the elevation of one of the points, this point will then appear in the list of points for *Site #2*.
- Reset all local edits (that is, remove all point edits made at the SN10, and restore BOTH sites to just as they were loaded from the PC) on the [SN10 Resets](#) page.
- You can't see or edit some of the point description at the SN10 (the airport identifier, airport description text must be prepared on a PC). The *Point Edit* page is just for last-minute point corrections in the field !
- To undo an edit you made to a point at the SN10, select the point to be restored, place the cursor on **Restore** and press **ENTER**. The point will be restored to exactly as it was loaded from the PC, and the * in the upper right will disappear (* indicates this point was edited at the SN10).
- An unedited point will show **Delete** instead of **Restore**. Place the cursor on **Delete** and press **ENTER** to delete the point from the site.

5.6 Glider Polar Setup

The SN10 contains polars for more than 60 different gliders. Select the proper glider and set the proper weight on the *Glider Polar* page. You can also enter a custom polar on this page if your glider is not already in the SN10, or if you feel the polar for your glider needs adjustment.

Glider Polar		
S-6/15		
Dry Gross:		796
Full water:		37
Std Weight:		796
V: 53.9	S: 131	G: 412
V: 75.0	S: 214	G: 351
V100.0	S: 395	G: 253

First, select the correct glider type. Then, enter your dry gross weight (ready-to-fly weight for you in this glider, with all your normal flight equipment, but without any water ballast) in the **Dry Gross** field. Finally, set the maximum water ballast you will carry in the **Full Water** field.

CAUTION	<p>An incorrect weight will cause incorrect speed-to-fly, incorrect final glide information, incorrect Netto, and other errors. Make sure to set the correct dry gross weight for this glider and pilot.</p>
----------------	---

Some gliders also exhibit better performance at higher wing-loadings due to Reynolds Number effects. For example, DFVLR measurements show the original Ventus has a noticeably better polar and maximum L/D at higher wing loadings. In such cases we have fit the better (heavier) polar, and you may want to add 1-2% bugs for best accuracy when flying dry.

The SN10 uses a quadratic rather than a higher-order polar. Some gliders exhibit a sharp fall-off in performance after some high speed (for example, the Discus). This is not a factor as you never fly in this rather bad performance range unless you make a very serious error on final glide or omit water ballast ! The SN10 polars are fitted to closely match the glider performance in the normal operating speed range. In practice, the largest source of polar error is an incorrect weight (due to inaccurate water input, or incorrect setting of the Dry Gross on this page).

To enter a custom polar, select one of **Custom 1** – **Custom 3** where you normally choose a sailplane type. Next, enter three points that describe the best-fit quadratic polar by entering three sink points (velocity **V** and sink rate **S**, typically at best L/D, medium cruise, and fast cruise). Finally, enter the correct Std Weight (flight weight for which this polar is valid), which is usually different from your personal dry (unballasted) gross weight.

5.7 Airspeed Calibration Setup

The airspeed calibration page allows you to compensate for known airspeed errors. If your airspeed system is accurate within a couple of knots, you do not need to use this page. However, if your airspeed system has errors larger than a few knots in your normal flying speed range, fill in the table on this page from your glider handbook. A poorly calibrated airspeed system will reduce the performance of the SN10 wind measurement system !

Airspeed Cal			
Reset			
IAS	CAS	IAS	CAS
38	38	81	81
46	46	92	92
49	49	103	103
59	59	119	119
70	70	135	135

Fill in the table of IAS to CAS calibration points, using the calibration curve from your ship's manual. Hint: Set the units for speed and climb to the same units used in the calibration chart to enter this information, and change the units back to your preference after you're finished (let the SN10 perform the units conversion for you).

5.8 SN10 Options 1 Setup

Use this page and the *SN10 Options 2* page to chose among the many SN10 options.

5.8.1 Map Alternates

Check this box to display alternate landing fields on the moving map (both competition and club mode). See the [Moving Map Page](#) for more information on this option.

SN10 Options 1	
<input type="checkbox"/> MapAlt	<input checked="" type="checkbox"/> Camera
<input type="checkbox"/> Photo Start	
2-seat LCD:	0
Task: Competition	
External Switch	
GPS: NMEA	
English	

5.8.2 Camera (Suppress Near Turnpoint alert)

Check this box to suppress the "Close to turnpoint" alert message. Also, if you fly with cameras, check this box if you have connected an external "Camera Fire" momentary switch (depressing this switch takes a picture and provides the SN10 'photo taken' input).

5.8.3 Photo Start

Check this option if taking a photo with a camera starts the task (only useful if you fly with a camera using some old rules, and you have the SN10 camera switch input connected).

5.8.4 2-Seat LCD Contrast

If you have a two-seat SN10, you can adjust the contrast of the 2nd seat display a small amount with this setting. Change this only from the 2nd seat SN10 display (if you change this on the main unit, you cannot see the contrast change).

5.8.5 Task: *Competition* or *Touring*

If you set *Competition* here, only those points marked *Turnpoint* in the SN10 database will be available to select as turnpoints on the task page. Select *Touring* if you want both turnpoints and points marked *Airport* available as turnpoints for your task. *Touring* is a useful setting while flying casually, when you want all the airports in the database available on the task page.

5.8.6 Cruise/Climb Switching

Select **External Switch** if you are using a switch such as a flap switch, trim switch, or switch on the stick to control the cruise/climb variometer switching. Select **Automatic** if you wish the SN10 to automatically detect circling with the built-in G-meter, switching to climb vario when circling is detected.

5.8.7 GPS Type

Select **NMEA** for any GPS unit that provides an NMEA output stream. This includes all IGC-approved flight recorders we know of, and most commercial GPS units except the very cheapest. If you have no GPS connected, select **None**.

The SN10 requires GPS NMEA-183 data to be transmitted to the SN10 at 4800 baud, per the NMEA standard. If your GPS has a user-adjustable NMEA transmit baud rate, set it to 4800. If your GPS has user-configurable NMEA sentences, select (GP)RMC and (GP)GGA (if these aren't available, select GLL).

5.8.8 Language

Select either *English* or *German* with this option. All HELP text and SN10 messages will be given in the selected language, and selected fields will be displayed differently as well.

5.9 SN10 Options 2 Setup

5.9.1 Enable Club Mode

If you check this box, each time the SN10 is turned on, the SN10 asks whether you want club or competition mode. If you do not check this box, the SN10 will always operate in competition mode. When the SN10 is turned on in flight no question is asked and the SN10 continues operating in whatever mode was in use at takeoff.

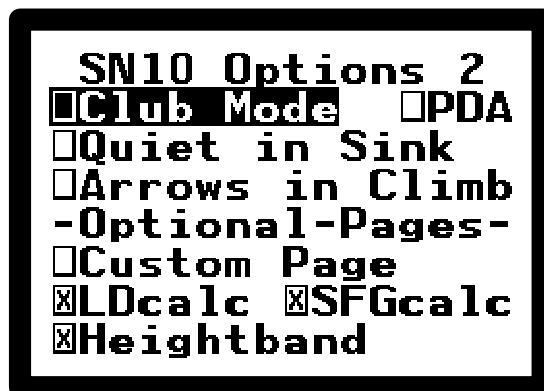

5.9.2 Enable PDA Output

Checking this box causes the ILEC SN10 to output information for use by some PDA software. This information includes all information that the SN10 receives from the GPS input, plus additional information measured or computed by the SN10. With this information, the PDA software can provide better information about alternate landing points. Numerous PDA software packages now use this data (contact your PDA software vendor for more information).

5.9.3 Be Quiet in Sink

Checking this box suppresses *Speed-Up* audio signals when you're in cruise. Some pilots prefer not to have the additional stress of the audio on top of the altimeter unwinding...

5.9.4 Enable Arrows in Climb

Normally, the ILEC SN10 does not display arrows indicating *Turn-Right to track the course-line*, or the wind-direction arrow during climb. Most pilots find that while they're thermalling, the continually changing arrows are quite distracting. If you don't mind the arrows continually changing while climbing, check this box to enable their display in climb.

5.9.5 Enable The Custom Page

If you check this box, the first SN10 page (in competition mode) will be the *Custom* page. See [The Custom Page \(optional\)](#) and [Customizing the Custom Page](#) for information about the *Custom* page.

5.9.6 Enable L/D Calculator Page

Check this box to enable display of the [L/D Calculator Page](#). This page is primarily used by pilots who fly modified single speed (to find the MC setting that matches the

speed at which they wish to cruise). If you are flying classic MC and do not find it helpful to check the expected cruise and achieved average speeds, uncheck this box to disable the page.

5.9.7 Enable Simple Final Glide Page

Check this box to enable display of the optional [Simple Final Glide Page](#) page. If you do not want to do scratch-pad final glide calculations, uncheck this box to disable this page.

5.9.8 Enable Heightband Page

Check this box to enable display of the optional [Thermal Heightband Page](#) page. If you do not find the heightband graph helpful, uncheck this box to disable this page.

5.10 SN10 Resets

To perform one of the following *Reset* operations, place the cursor on the field described and press **ENTER**.

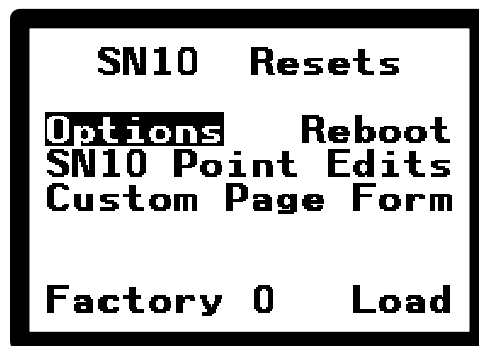

5.10.1 Options

Resets all SN10 settings to the factory defaults, including units, audio and vario selections, glider type, airspeed calibration, custom page layout, glider and pilot ID for flight recorder, and all option selections.

5.10.2 Reboot

This reset restarts the SN10 software. Should never be necessary !

5.10.3 SN10 Point Edits

This reset undoes any point edits done at the SN10. This restores all deleted points, and returns all edited points to exactly as loaded from the PC.

5.10.4 Custom Page Form

This reset restores the *Custom* page layout to the factory default.

5.10.5 Factory 0

For correct operation of the SN10, this must remain set to **Factory 0**. This field is for factory use only ! Changing this value may cause the SN10 to operate improperly.

5.10.6 Load

This shuts down the SN10 software, and readies the SN10 for receiving a new version of its operating software from a PC. See [Updating the SN10 Operating Software](#) below.

5.11 Raw Sensors Diagnostic Page

The *Raw Sensors* page shows the current measurements from the SN10 sensors. Use this page to check the function of the SN10 sensor system.

The SN10 G-meter can also be adjusted using this page. If the SN10 is installed so that it is not level in flight attitude, it is necessary to adjust the G-meter for proper automatic detection of circling for cruise/climb switching.

To trim the G-meter, fly the sailplane in slow flight, place the cursor on **G: 1.00**, and adjust the value to 1.00. If the value already reads 1.00 as in the illustration, no adjustment is required.

The indicated airspeed **IAS** should match an accurate mechanical airspeed indicator. When the glider is sitting still, the IAS will typically read a low value such as 6. This is normal and not important.

The **Compass** field displays the expected compass heading during cruise for the current task.

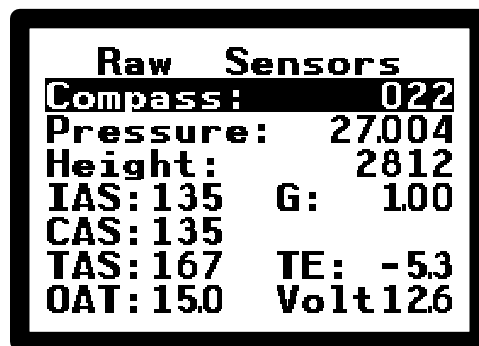

Raw Sensors	
Compass:	022
Pressure:	27004
Height:	2812
IAS: 135	G: 1.00
CAS: 135	
TAS: 167	TE: -5.3
OAT: 150	Volt 126

5.12 Customizing the *Custom* Page

To configure the *Custom* page, you must first enable the *Custom Page* option on the [SN10 Options 2](#) page. With the *Custom* page enabled, and in Setup mode, the SN10 shows the *Custom Page Setup* page immediately before the *Custom* page.

This setup page shows, for each display position on the *Custom* page, the field to display, and whether to display this field using normal or double-height characters. Reset to the default display layout with the [Custom Page Form reset on the SN10 Resets page](#).

Illustrated below is the SN10 default for the *Custom* page:

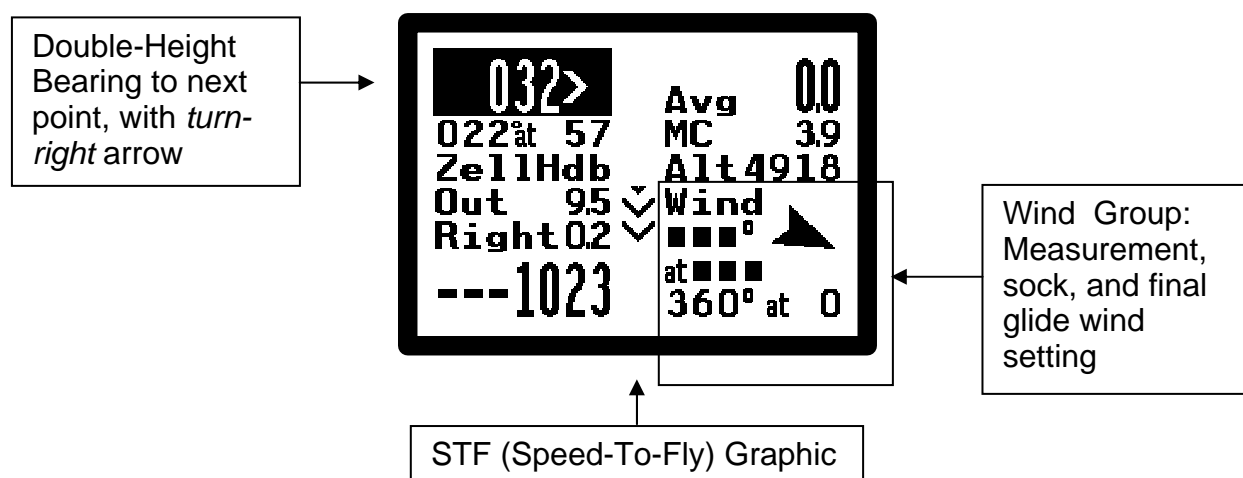

The *Custom Page Setup* page that creates this display layout is:



NOTE

- The tall **2** before a field choice means display double-height (**1** is single height).
- The small **s** at the top center selects the graphic to display in the center of the page (**s** for speed-to-fly, **f** for final glide like on the status and task pages).
- Press **HELP** on any field for a complete explanation what the current choice will display.

5.13 Task Rules Page

Use the *Task Rules* page to set the type of task, and options for start, turnpoint, and finish. The settings on this page control both how the start, turnpoints, and finish are displayed on the moving map, and also how the SN10 automatically acknowledges the start, turnpoints, and finish of your task.

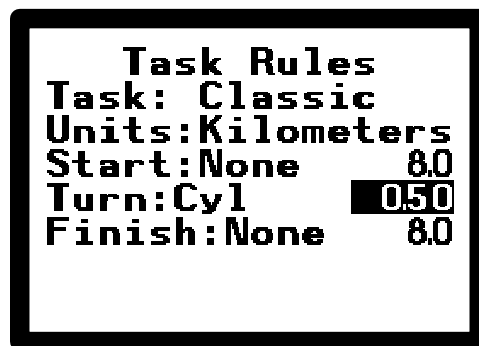

Set the **Task** type to *Classic* or *AAT* (Assigned Area Task, also called TAT or PAST in some countries). The classic task uses fixed turnpoints, where the AAT uses large turn areas. [See the AAT chapter](#) for a complete explanation of how to use the SN10 for AAT.

For both *Classic* and *AAT* tasks, start and finish processing are set on the *Task Rules* page. Place the cursor on **Start** or **Finish**, and adjust **VALUE** to select from the available rules: Line, Cylinder, or FAI Sector. To the right of the rule selection, set the size; this is the width of the start or finish line, the radius of the start/finish cylinder (careful, radius is half the diameter), or the size of the permissible FAI-style arc. To suppress automatic start and finish processing, select *None* as above.

For *Classic* tasks, set the style of turnpoint rule in use in the **Turn** field to either cylinder or FAI Sector, and set the cylinder or FAI sector radius to the right. This setting is ignored for *AAT* task.

Set the **Units** for the task rules on this page. This sets the units in use for the start, turn, and finish feature sizes selected above, and also the units for the AAT task radius settings. Note: This setting does not affect distances displayed for the task or navigation.

5.13.1 Start and Finish Cylinders

You start a task by exiting a start cylinder, either by flying out the side or out the top. The start point (center of the cylinder), cylinder size, and optional cylinder height are given each day by the competition director. Set the cylinder radius each day on the SN10 Task Rules page, as well as setting the start point on the task page. The first time you enter the start cylinder, the SN10 beeps to confirm you are ready to start. When you exit the cylinder side, the SN10 will beep and ask if you want to make a start (press **ENTER** if so, press **HELP** if not). When you confirm the start, the SN10 will display the start time.

The SN10 **does not** track start cylinder height or a start if the glider exits the top of the cylinder (this is supposed to be rare according to the head of the USA competition committee). If you start the task by exiting the top of the cylinder, manually tell the SN10 you have started (place the cursor on the start point and press **ENTER**). Please study the USA rules carefully to understand the height restrictions and limits !

The SN10 also **does not** track time between starts. In some countries, the rules require a minimum interval between starts; in this case you must ensure you don't start before the required interval has elapsed (to help with this, the most recent start time is displayed on the *Timer* page). A start event is written in the SN10 flight record when you confirm a start, for those countries where this is required.

When you enter the finish cylinder after achieving all turnpoints, the SN10 will beep and confirm your finish, and finalize all statistics.

5.13.2 Start and Finish Lines

When you select a start or finish line, you will see the line(s) drawn on the moving map. When you cross the start line in the correct direction, the SN10 will beep and ask you if you want to make a start (press **ENTER** if so, press **HELP** if not). The SN10 does not keep track of any height or speed restrictions; you must ensure you comply with any such rules. Elapsed time between starts is not monitored by the SN10.

When you cross the finish line after achieving all turnpoints, the SN10 will beep and confirm your finish, and finalize all statistics.

CAUTION	<p>It is possible to get a turnpoint confirmation from the SN10 even though your external IGC-certified “secure” flight recorder did not record a point in the sector or cylinder. Many pilots use the SN10 flight recorder as a backup, with an IGC-certified “secure” flight recorder as the primary flight recorder. If you use the separate recorder to provide GPS input to the SN10, please note: External loggers usually provide fixes to the SN10 every 2 seconds, but usually do not record every fix in their memory. Be sure to set your external logger to save fixes often enough so you do not fly through the turnpoint cylinder/sector, receive an ‘achieved turnpoint’ message from the SN10, and fly onwards – only to find out the external logger did not record the critical fix in its memory!</p> <p>USA Pilots: You can accidentally set the wrong turnpoint cylinder size. The units for the USA turnpoint cylinder radius will be displayed with the units you selected during setup, but USA rules specify the standard turnpoint cylinder to be .25 statute miles. If you set the distance units to something other than statute miles, take special care to set the cylinder size appropriately (.25sm = .22nm = .40km). Confirm the units with HELP.</p>
----------------	---

5.14 Flight Recorder Page

The SN10's internal flight recorder automatically starts each time you take off, and will record more than one flight in a single day. When you turn on the SN10, it will warn you if you have not saved the most recent flying day's flight record. On take-off, any prior day's record will be erased.

Use the SN10 *Flight Recorder* page to input your contest ID and name, to control the SN10 internal flight recorder, and to see the current flight recorder status. For normal operation, you will not need to use this page.

Place the cursor on **Stop** and press **ENTER** to manually stop the flight recorder and calculate the flight record's digital signature (when the recorder is not running this field will show **Start** so you can manually start the recorder). Place the cursor on **Reset** and press **ENTER** to clear an unwanted flight log from the SN10.



NOTE

- The SN10 flight recorder only records one day's flights, up to about 13 hours. The fix interval is two seconds (not adjustable, and less frequent if your GPS provides fixes at intervals greater than 2 seconds).
- The SN10 flight recorder is not IGC approved, so you cannot use it for verifying an FAI badge flight. In many countries, the SN10 flight recorder is approved for use in contests (for example USA contests or the OLC Online Contest "Blue Smiley").
- After the flight, use your PC to get the flight record from the SN10. [See using the SN10 with your PC for more information.](#)
- The output file created by the SN10 on your PC is in the IGC standard format, which can be read by many different software packages. These can help you display and analyze your flight, perform contest scoring, etc.

6 Using the SN10 with Your PC

Use a PC to update the SN10 to a new software version, load site database information into the SN10, and to retrieve flight logs in IGC format after a flight. Your SN-10 includes software compatible with both older DOS PC's and Microsoft Windows PC's (either 16-bit Windows 3.1, or 32-bit Windows 95, 98, ME, NT, or 2000). This software also works on modern Macintosh PCs running under MacOS 8.6 or later and which include Microsoft Windows running under Connectix Virtual PC Version 3.0 or later.

You can download the latest SN-10 software from ILECs web site or your dealers web site.

The PC must have a serial port to communicate with the SN10. Almost all older PCs have a serial port. For newer computers with USB and no serial port (and running a version of Windows that supports USB), you must use a USB-to-serial converter.

You normally download a prepared SN10 database file (NDB file) from the Internet. Alternatively, you can create your own custom NDB file on your PC, using one of many methods to edit or create an NDB file.

This chapter explains how to install the SN10 utility software on your PC, how to load NDB files into your SN10, how to retrieve your IGC-format flight record (datalog) from your SN10, and how to perform SN10 software updates.

6.1 Installing SN10 Support Software on Your PC

The SN10 support software for your PC includes:

- Utilities to move site data and flight logs between your PC and the SN10,
- Software and utilities to upgrade the software inside the SN10,
- SN10 software release notes README.TXT,
- Flight log security validation program VALI-IEC.EXE, and
- Utilities and help files for site preparation and checking.

The SN10 setup program installs this software on your PC.

Obtain a copy of the SN10 setup program from ILEC's Internet web site <http://www.ilec-gmbh.com/>, or from your ILEC dealer's web site. This setup program will be named according to the version number; for example SN10 version 2.25 is named **Setup225.EXE**. For the SN10B, the setup program will have a 'B' suffix, for example **Setup225B.EXE**. It is important to use the correct software for the model of your SN-10; either SN-10 or SN-10B. Use this setup program to install SN10 software as follows:

- **Microsoft Windows 95, 98, Me, NT, 2000, and Mac:** Find the **Setup225** file in the Windows Explorer, and double-click on **Setup225**. Unless you are an experienced computer user, allow the setup program to place all your SN10 files in the default folder C:\SN10 (Mac users, perform this procedure using Windows, not the Mac OS). The SN10 programs and help files will now be available from your Start menu (via Program files, SN10 Utilities), or you can access them directly via Windows Explorer from the C:\SN10 folder.
- **Microsoft Windows 3.x (old 16-bit Windows):** Find the **Setup225** file in the File Manager, and double-click on **Setup225**. Unless you are an experienced computer user, allow the setup program to place all your SN10 files in the default folder C:\SN10. The SN10 programs and help files will now be available from the program group "SN10 Utilities" created on your desktop, or via File Manager from the C:\SN10 folder.
- **Microsoft MS-DOS:** Run the **Setup225** program. Unless you are an experienced computer user, allow the setup program to place all your SN10 files in the default folder C:\SN10.

6.2 Using SN10 PC Software with MS-DOS or Windows 3.x

If you are using Windows 95 or later, please skip this section !

The SN10 16-bit MS-DOS and Windows 3.x PC Link program (HL.EXE, also called Host Link) requires at least 600kb available low memory for programs. "Low Memory" should not be confused with the amount of memory available on a PC! It is common to find a Windows 3.1 or DOS machine with 4 Megabytes of memory, but only 500kb of available low memory.

Check the available low memory using the DOS command: **mem /c**
You need the *largest executable program size* to be at least 600K.

If this is not the case, you will need to change the CONFIG.SYS and/or AUTOEXEC.BAT files to remove device drivers loaded in low DOS memory. You may have to find a local computer expert to help !

Hint: Create a DOS boot floppy with minimal drivers, and with an AUTOEXEC.BAT that changes to the C: drive and the C:\SN10 directory, and finally starts the program HL. Use this boot floppy with your SN10, then remove it and boot as normal when you've completed your transfer.

6.3 Using Prepared Site Database Files (NDB files)

An SN10 database is contained in a PC file with the suffix NDB. Most pilots use pre-prepared NDB files from ILEC or from the Worldwide Soaring Turnpoint Exchange on the Web (<http://acro.harvard.edu/SSA/JL/TP/HomePage.html>).

Make sure to place the NDB files you wish to use in your C:\SN10 folder !

CAUTION	<p>Microsoft Internet Explorer Users: Due to a Microsoft quirk, you will fail to successfully download an NDB file unless you follow these special instructions (Netscape users currently report no problems, and can disregard these special instructions):</p> <p>When downloading files from the Worldwide Soaring Turnpoint Exchange, make sure you Right-Click on the file icon for the ILEC SN10 to and select "Save Target As..." to download the NDB file. Alternatively, follow the painful instructions on the Web site and configure Windows to avoid "helping" by changing the file extension or adding a .TXT extension. If you don't do this, you will find the NDB file given a .TXT extension and/or the contents of the NDB file unusable, and you will be extremely frustrated !</p>
----------------	--

6.4 Starting the SN10 to PC Link

With the SN10 PCLink software, you can easily transfer an NDB (site database) file from a PC to the SN10, or to retrieve a flight log from the SN10 into a PC.

6.4.1 Start the PCLink (HostLink) Program on the PC

Start the PC Link program on the PC (also called HostLink) as follows:

- **Microsoft Windows 95, 98, Me, NT, 2000, and Mac:** Click on the Windows *Start* button, then on *Program Files*, then *SN10 Utilities*, then **PCLink (HL32)**.
- **Microsoft Windows 3.x:** First, make sure you've followed the instructions in [Using SN10 PC Software with MS-DOS or Windows 3.x](#) above. Open the *SN10* program group on your desktop, and double-click on **PCLink (HL)**.
- **Microsoft MS-DOS:** First, make sure you've followed the instructions in [Using SN10 PC Software with MS-DOS or Windows 3.x](#) above. Change directory to your SN10 directory (type **C:**, then **CD \SN10**). Run the HL.EXE program (type **HL**).

The PC program will try to connect to the SN10. All operations from this point further are controlled on the SN10, as most computer screens are not visible in sunlight. You can start HostLink on your laptop, close the screen, walk outside to the glider, and connect the PC cable to the panel connector or the right rear of the SN-10. Before you do this, make sure your laptop computer is not configured to power-off as soon as you close the screen !

6.4.2 Connect the PC to the SN10 with the ILEC PC Cable

Connect the PC serial port to the SN10 panel connector with the supplied PC cable.

 CAUTION	<p>Using the wrong cable may damage your PC.</p> <p>You MUST use the ILEC PC cable supplied with your SN10 to connect to your PC.</p>
--	---

Turn on your SN10, and you will shortly see the *PCLink Started* message, after which the *PCLink* page will display automatically.

NOTE: As long as the *PC cable* is plugged into the *SN10 Panel Cable*, the GPS input is disconnected from the SN10. If you leave the PC Cable plugged after you load new software or after you finish using the PC Link, you will see "No GPS Input" warning messages on the SN10.

6.4.3 Trouble-Shoot (If Required)

If you don't get the *PCLink Started* message:

- Verify no *power saver* options are enabled for the laptop serial port.
- Verify no other program is trying to use the Windows serial port, for example the Palm Pilot HotSync program, or a program you use to connect to a flight recorder.
- Verify no MS-DOS window is still active, other than the one for PC Link. Once a program in an MS-DOS window has used the serial port, the serial port will be unavailable to other windows until this window is closed.
- Check you have used the correct ILEC PC cable, all connections are secure and not loose, and there are no bent pins inside the cable connectors.
- Verify the SN10 is set to **GPS: NMEA** on the *SN10 Options 1* page.
- With Windows 98 or ME, see [Communication Problems with Microsoft Windows 98 & ME](#) below.
- With Windows NT or 2000, see [Communication Problems with Microsoft Windows NT and 2000](#) below.

6.5 Upload an NDB file from a PC to the SN10

Select Setup mode and turn to the Site page. Select the site you wish to load (site #1 or site #2), and erase the site if it is not already erased (see [Site Select](#) above). The site page should match the illustration at right (though the site may be #1).

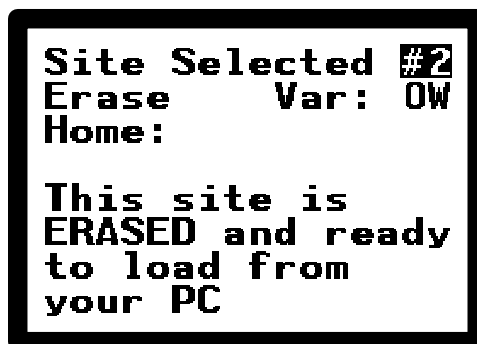

Start the PC Link (see [Starting the SN10 to PC Link](#) above).

You will see the PCLink screen as follows:

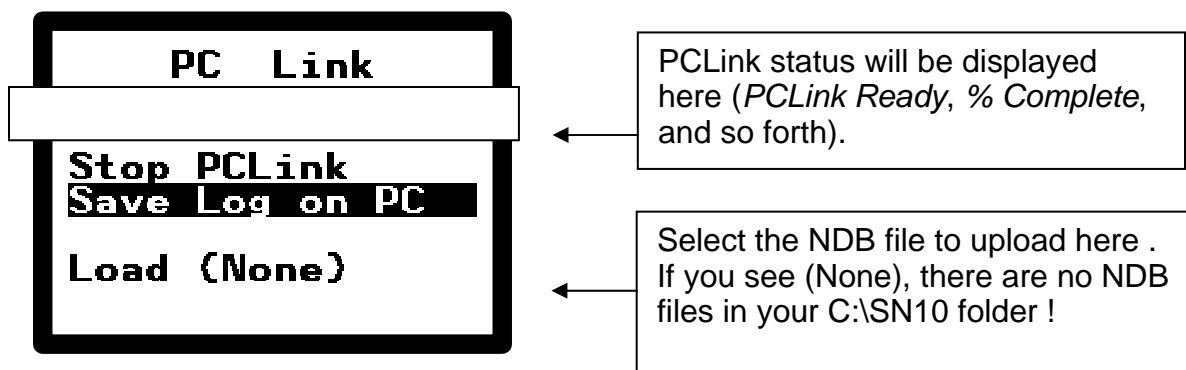

Place the cursor on the **Load** line, and change **VALUE** to select the NDB file you wish to load into the SN10. As you change **VALUE**, you'll see the text step through all of the NDB files you've placed in your C:\SN10 folder. When you find the NDB file you wish to load into the SN10, press **ENTER** to start the transfer.

NOTE

- If you see **Load (None)** as in the illustration, there are no NDB files available in the C:\SN10 folder. If you used Internet Explorer, and you think you really placed an NDB file in this folder, you may have fallen victim to Windows and Internet Explorer adding a .TXT suffix to the file name – in this case, try again following the instructions above in [Using Prepared Site Database Files \(NDB files\)](#).
- If you get an error message regarding the file contents, you have a problem with the NDB file. Usually, this is caused by problems with Windows and Internet Explorer, please try again following the instructions above in [Using Prepared Site Database Files \(NDB files\)](#). If you prepared the NDB file yourself, please check the file with the DBC database check program (see [Preparing a Custom Site Database File \(NDB file\)](#)) and correct its contents.

6.6 Download a Flight Record from the SN10 to a PC

Start the PC Link (see [Starting the SN10 to PC Link](#) above).

You will see the PCLink screen as follows:

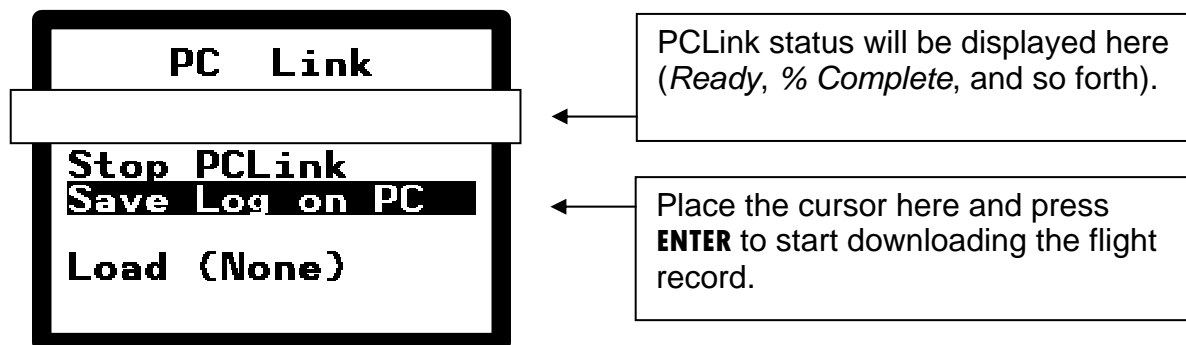

Place the cursor on the **Save Log on PC** and press **ENTER** to start downloading the flight record.

If you have not already stopped the flight recorder, it will be stopped now, and the SN10 will compute the flight record security key. Have patience, as the security computation can take several minutes ! You will see **The SN10 will now compute the IGC file security signature** message on the SN10. As soon as the security computation finishes, the PC Link will transfer the flight record to the PC.

While the PC Link transfers the flight record to the PC, the SN10 will show a status message with the percentage complete. When the transfer completes, you will see a message giving the name of the flight record file (a funny-looking name as specified by the IGC).

NOTE

- To save time during the download process, just after your flight, turn to the *Flight Recorder* page, place the cursor on **Stop** and press **ENTER** to stop the flight recorder. This starts the SN10 security key computation (which can take a few minutes), and the flight record will be ready to download when you bring your PC to the glider.
- To verify an SN10 flight log has not been tampered with or falsified, use the provided VALI-IEC MS-DOS program, per the IGC rules.

6.7 Preparing a Custom Site Database File (NDB file)

To prepare your own NDB file, we recommend you use the optional *StrePla* program, available from your ILEC dealer. Alternatively, in the USA, you can use Don Malin's *Site Planner* to create a site database from the FAA airport library (*Site Planner* is available from the Knauff & Grove web site www.eqlider.org).

In any case, make sure to place the NDB file you create in the C:\SN10 folder on your computer, so it is available to the PCLink program !

NOTE

- The NDB file consists of a list of points, optionally followed by airspace data. The airspace data is pre-processed text and not human editable. If you want to modify an NDB file that contains airspace information, remove and save the airspace data from the end of the NDB file, modify the file, and then replace the airspace data at the end of the file.
This is because *StrePla* and *Site Planner* don't do this automatically...
- If you're an experienced computer user, you can directly create an NDB file with any text editor like NOTEPAD. Do NOT use a word processor that inserts formatting information in the file, and do not use a spreadsheet program ! See the file **DBformat.TXT** in C:\SN10 for a detailed description of the NDB file format. After preparing or modifying an NDB file, use the database (NDB file) check program DBC.EXE (in C:\SN10). Run DBC in a DOS window (type **DBC mypoints.NDB** for example).

6.8 Preparing Map Data for Use with the SN10

It is possible to create your own map data for the SN10, but it is very time-consuming, and recommended for advanced PC users only. See the file **MapHelp.TXT** in C:\SN10 for details about preparing and using your own map data.

6.9 Updating the SN10 Operating Software

Periodically, Nadler & Associates and ILEC release a new version of the SN10 software. A major benefit of owning an ILEC SN10 is you can load this new software directly into the SN10, without removing the SN10 from the glider. All of your option settings and database information will be preserved.

Obtain a new version of the SN10 software, and install it on your PC (see [Installing SN10 Support Software on Your PC](#) above). Make sure any *power saver* features for your laptop serial port are disabled, make sure all DOS boxes are closed, and make sure no other programs are using the serial port. Then, start the SN10 *Software Load* program on the PC as follows:

- **Microsoft Windows 95, 98, Me, NT, 2000, and Mac:** Click on your Windows *Start* button, then on *Program Files*, then *SN10 Utilities*, then **Load New SN10 Software (SL32)**.
- **Microsoft Windows 3.x:** Open the *SN10 Utilities* program group on your desktop, and double-click on **Load New SN10 Software (SL)**.
- **Microsoft MS-DOS:** Change directory to your SN10 directory (type **C:** and then **CD \SN10**). Run the SL.EXE program (type **SL**).

You will now see the PC program trying to connect to the SN10. Connect the PC serial port to the SN10 panel connector, using the ILEC-supplied PC cable.

 CAUTION	<p>Using the wrong cable may damage your PC.</p> <p>You MUST use the ILEC PC cable supplied with your SN10 to connect to your PC.</p>
--	---

On the SN10, enter *Setup* mode, turn to the *SN10 Resets* page, place the cursor on **Load**, and press **ENTER**. After you press **ENTER** a second time to confirm, the SN10 screen will go blank (possibly with a blue appearance). This is normal. On the PC, you will see the software upload progress. After 4 or 5 minutes, the SN10 will restart with the new software.

While the software is loading, do not do anything else with your PC, do not interrupt the power, and do not disconnect the PC cable. If for any reason the software load process is interrupted, your SN10 will not function ! If this happens, stop the Software Load program on the PC (type Ctrl-C or Ctrl-Break), turn the SN10 off and on, then restart the Software Load program on the PC.

If you accidentally attempt to load the older SN10 software into an SN10B or visa-versa, the SN10 screen will be blank but you will hear an audio (dot-dot-dot-dash-dash-dash-dot-dot-dot). Just load the correct software (after the SOS, the SN10 will sit and wait for new software).

6.10 Updating the 2nd Seat SN10-2 Operating Software

The SN10-2 repeater unit (the 2nd seat SN10) requires software updates with some but not all version upgrades (check the release notes; the last required update for the repeater is 2.10 as of this manual).

Obtain a new version of the SN10 software, and install it on your PC (see [Installing SN10 Support Software on Your PC](#) above). Make sure any *power saver* features for your laptop serial port are disabled, make sure all DOS boxes are closed, and make sure no other programs are using the serial port. Then, start the SN10-2 2nd Seat Software Load program on the PC as follows:

- **Microsoft Windows 95, 98, Me, NT, 2000, and Mac:** Click on the Windows Start button, then on *Program Files*, then *SN10 Utilities*, then **Load 2nd Seat SN10 Software (SL32_SLV)**.
- **Microsoft Windows 3.x:** Open the SN10 Utilities group on the desktop, and Double-Click on the **Load 2nd Seat SN10 Software (SL_SLAVE) icon**.
- **Microsoft MS-DOS:** Change directory to the SN10 directory (type **C:**, then **CD \SN10**). Run the SL_SLAVE.BAT program (type **SL_SLAVE**).

You will now see the PC program trying to connect to the SN10.

Connect your PC serial port to the SN10-2 (2nd seat SN10 unit) **right-side** (right side of glider) DB9 connector, labeled "PC" using the ILEC-supplied PC cable.

 CAUTION	<p>Using the wrong cable may damage your PC.</p> <p>You MUST use the ILEC PC cable supplied with your SN10 to connect to your PC.</p>
--	---

Take a paper clip and straighten 2" of it. Gently insert the straightened end of the paper clip into the small reset hole just **left** of top-dead-center on the SN10-2 (2nd seat SN10 unit) face (careful: **not** the hole at top center). Press in gently and you will feel a small switch click. While holding in the paper clip, turn on the main SN10. The SN10-2 screen will go blank (possibly with a blue appearance). This is normal. On the PC, you will see the software upload progress for about 2 minutes, and then the SN10-2 will restart.

While the software is loading, do not do anything else with the PC, do not interrupt the power, and do not disconnect the PC cable. If for any reason the software load process is interrupted, your SN10 will not function ! If this happens, stop the Software Load program on the PC (type Ctrl-C or Escape), turn the SN10 off and on, then restart the Software Load SL_SLAVE program on the PC.

6.11 Communication Problems with Microsoft Windows 98 & ME

Serial communications under Microsoft Windows 98 and ME is extremely buggy. Sometimes, a serial port just stops working properly, and even shutting down and restarting/rebooting Windows does not fix the problem. This problem has been observed on different brands of computer, using software for many different brands of flight computers and flight recorders !

If this happens to you, try the following:

- Right-Click on the *My Computer* icon on your desktop,
- Left-click on the *Properties* menu choice,
- Left-click on the *Device Manager* tab,
- Left-click on the + symbol next to *Ports (COM and LPT)* to show all ports,
- Right-click on the serial port you are trying to use (normally COM1),
- Left-click on the *Remove* menu choice,
- Click on *OK* to remove the device,
- Shut down and restart windows (don't just suspend and resume). When Windows restarts, it will discover the COM (serial) port, reinstall the driver, and it will resume operation, at least for a while.

Sometimes, this painful procedure must be repeated every few days !

6.12 Communication Problems with Microsoft Windows NT, 2000, XP

Serial communications under Microsoft Windows NT, 2000, and XP is buggy.

The Suspend/Resume and Hibernate/Resume features of these versions of Windows often leave the serial port dysfunctional after resume. If you have a problem with your notebook computer's serial port after using the Suspend/Resume feature, try restarting the computer (click on the *Start* button, select *Shut Down*, then select *Restart* – and please do not ask us why you must press *Start* to stop the computer).

Rarely, a serial port just stops working properly, and even shutting down and restarting/rebooting Windows does not fix the problem. In this case removing the device driver (as described above for Windows 98 & ME) may cure the problem. In some cases with NT and 2000, it is necessary to remove the device driver as above, boot to the BIOS SETUP and disable the COM port at the BIOS level, restart NT/2000 and verify that it has removed the serial port, reboot to the BIOS SETUP, re-enable the COM port, and then restart NT/2000. When NT/2000 is restarted, it will rediscover the serial port and install the serial drivers properly. If you are not an experienced computer driver, you may want to get help before attempting this procedure.

6.13 USB Serial Communication Problems

Many new PCs and Macs do not have classic serial ports; instead they have USB. You need a **USB-to-Serial-Adapter** for these PCs to communicate with the ILEC SN10. Unfortunately, the device drivers provided with many of the adapters are extremely buggy, to the point that they only work with certain communications settings, crash the computer on attempting to resume after a “suspend” operation, etc.

To avoid problems:

- PC users, buy a Belkin brand USB-to-Serial adapter, and ignore the Windows warning messages when installing the driver. Mac users, buy Keyspan. Alternatively, if your computer has a PC-Card (PCMCIA) slot, you can purchase a Socket PCMCIA RS-232 card.
- Configure the adapter's serial port in the range COM1 to COM8.

We maintain a list of customer experiences with different adapters (some work properly, most do not) at:

http://www.nadler.com/sn10/SN10_USB_Serial_Notes.html

7 SN10 Club Mode

SN10 Club Mode is for the pilot who wants the simplest possible final glide, alternate airport, airspace, and wind information. Club Mode allows instant use of the SN10 by pilots with little or no introduction to the instrument. In Club Mode, the SN10 shows everything you need on just 4 pages: a moving map, final glide information, settings, and wind measurement.

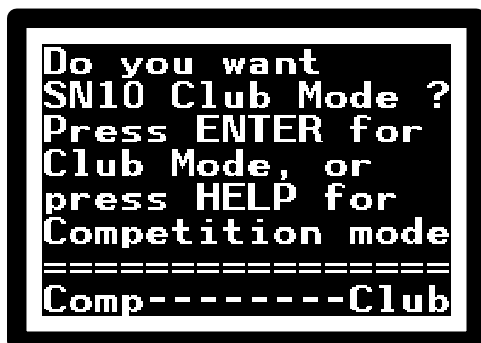

With *Club Mode* enabled, each time you turn on the SN10 you will be asked whether you want *Club Mode* or *Competition Mode*. This makes the SN10 ideal for clubs with pilots who prefer *Club Mode* as well as pilots who want the full *Competition Mode* for badge, competition, and record flying.

When the GPS commences operation, the SN10 finds the current airfield information in the database, and asks the question in the illustration.

Press **ENTER** to confirm this information. If you press the wrong button, turn the SN10 off and on again, and try again.

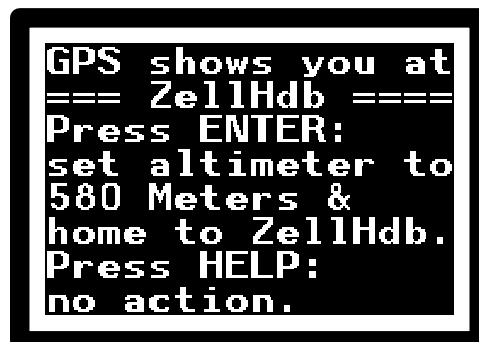

The SN10 will now display final glide information back to the home field, with an arrival altitude of 150 meters (500 feet). No further setup is required !

7.1 Club Mode Final Glide Page

Here's the final glide page:

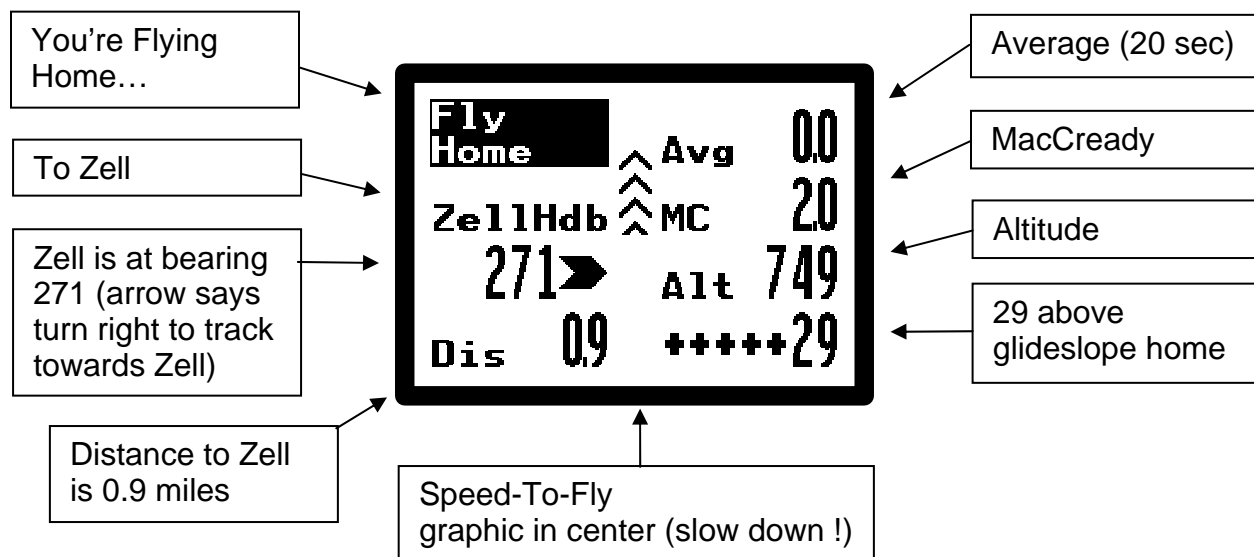

7.1.1 Club Mode Alternates

If you want to find an alternate landing point, place the cursor on **Fly Home**, and change **VALUE** until you see **Fly to Alternat** as below:

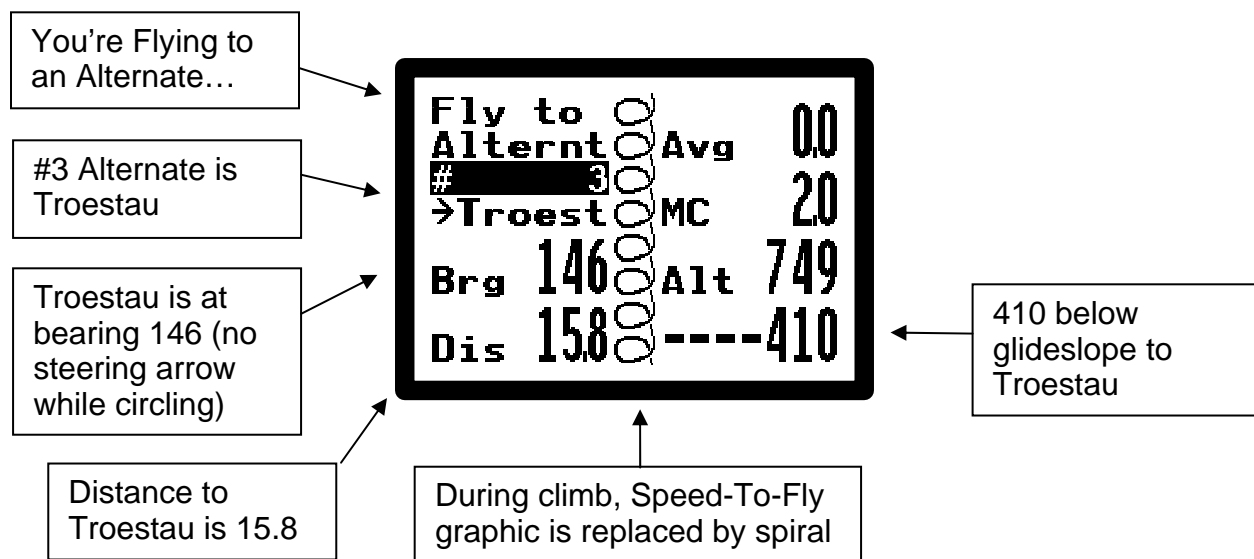

Troestau is the #3 alternate (3rd closest). Place the cursor on **#3** and rotate the **VALUE** knob to see the closest (#1) or other alternates. For information about Troestau, place the cursor on **Troest** and press **HELP**.

WARNING	<p>The landing point displayed by the SN10 may not be a safe place to land. You must be careful your SN10 database has current data. Airports become unlandable, farm fields entered as landing point may have high crops, and sometimes errors are made in entering coordinates or elevation into the database. Don't final glide to a point unless you are sure the coordinates and elevation are correct and it's currently a safe landing spot. We have heard about a pilot who final-glided to a heliport (accidentally entered in the database), and another who final-glided to a closed airport.</p> <p>Place the cursor on the selected alternate (Troest above) and press HELP to check the coordinates and airport information.</p> <p>There may be an obstacle between you and the landing point. The SN10 does not know about hills, mountains, and obstacles between you and the alternate landing point. Double-check with a current map. A famous pilot we know tried to final glide through a mountain (it didn't work).</p>
----------------	---

If you want to find a specific point other than home, place the cursor on **Fly Home**, and change **VALUE** until you see **Fly to Choice** as below. Then, place the cursor on the destination name, and adjust **VALUE** to select your destination (Wasserkuppe in the illustration below):

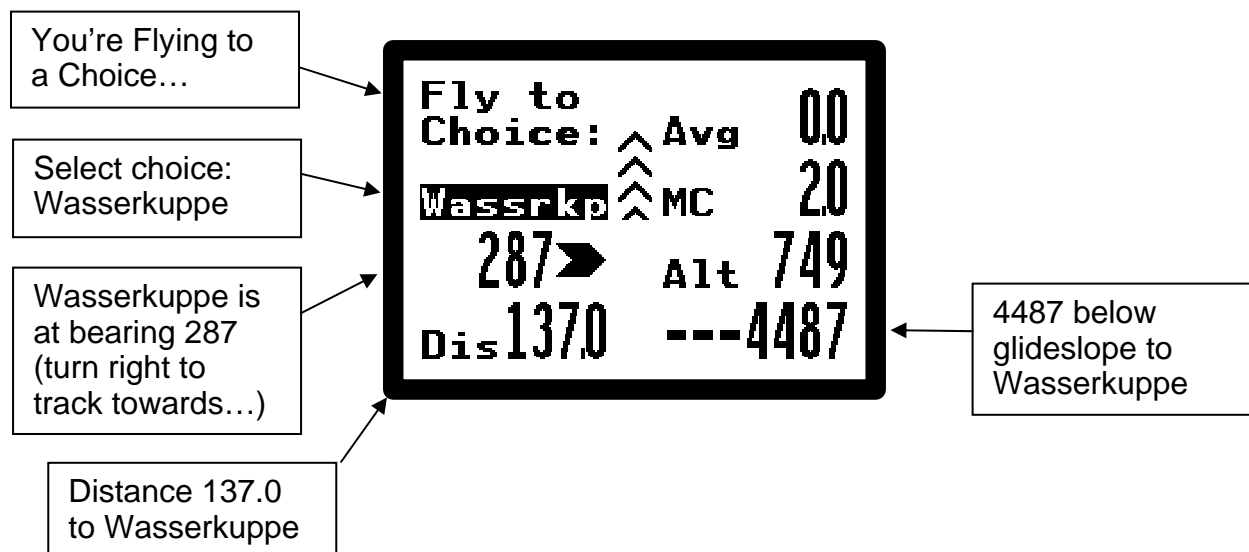

With the cursor on the destination **Wassrkp**, press **HELP** for complete information about the destination from the SN10 database.

7.2 Club Mode Settings Page

Use the *Club Settings* page to adjust the altimeter, change the desired arrival altitude for your final glide, or set the vario speed, water ballast, or percent decrease in max LD due to bugs on the wing.

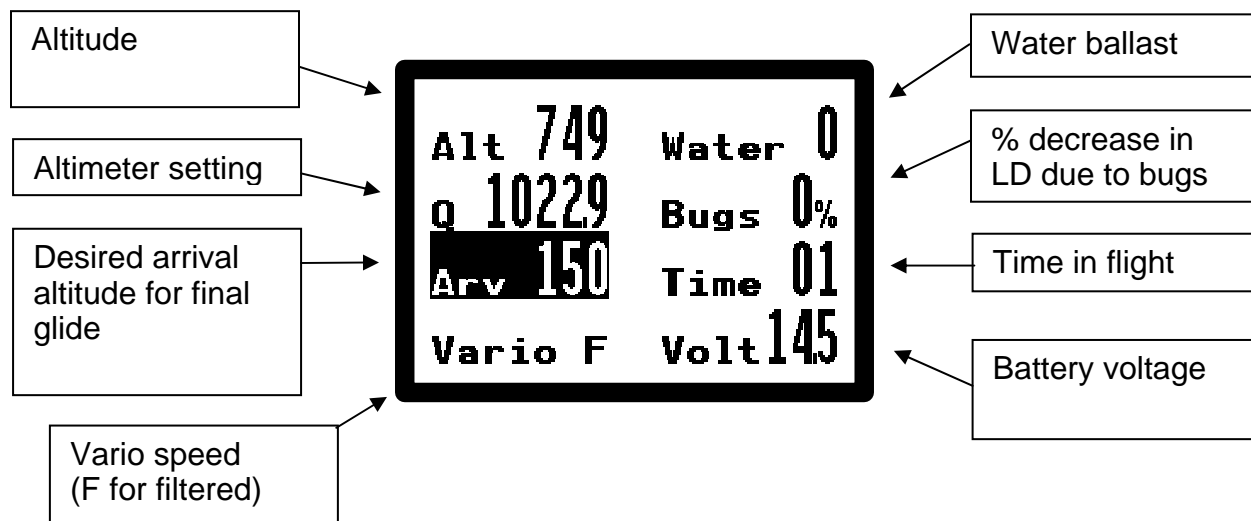

7.3 Club Mode Moving Map Page

The SN10 can show airspace boundaries, and the course-line to your selected destination (normally home). In the bottom center you see the glider, with the dotted line to the destination. The boxes show airspace boundaries. In the lower right, the arrow points North. In the lower left, you can change **VALUE** to zoom in and out, or place the cursor on one of the arrows and rotate the **VALUE** knob to scroll the map North-South or East-West.

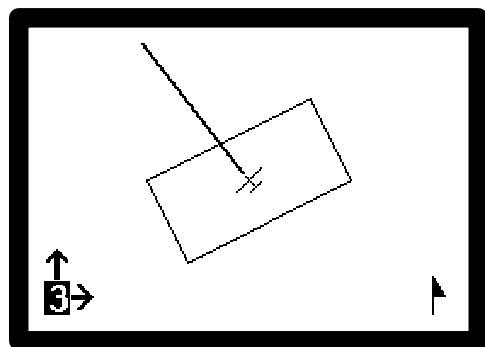
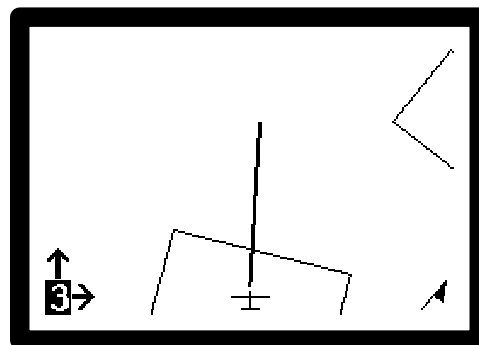

In the illustration above, the map is rotated to match what you see outside (we call this *Nose-Up*), and the arrow in the lower right rotates to point North. If you prefer, you can use the moving map *North-Up* as shown in the illustration at left. *North-Up* shows the map with North at the top, the North arrow in the lower right always points up, and the glider rotates in the center of the screen to show your current flight direction. Press **ENTER** to toggle the moving map between *North-Up* and *Nose-Up* presentations (this also resets any map scrolling).

7.3.1 Alternate Landing Points on the Club Moving Map Page

The SN10 optionally displays alternate landing points on the moving map, along with glideslope information for final glide to a selected alternate (check **MapAlt** on the [SN10 Options 1](#) page), as follows:

- The closest 5 landing points are displayed on the moving map (only if they are within the area currently displayed on-screen).
- A "+" symbol marks an alternate in range, "-" marks an alternate out of range, and "u" marks an alternate whose elevation is not known.
- The number at the top left of the screen selects an alternate. Set this number to "0" to use the moving map as normal. Change this number to 1 to select the closest alternate, 2 the next closest, up to 5 for the 5th closest.
- When an alternate is selected (the alternate number is set from 1 to 5 at top left):
 - a thick solid line is drawn from the glider to the alternate,
 - the selected alternate's name is displayed at the top of the screen,
 - the altitude above or below glideslope to the selected alternate is displayed at top right of the map, and
 - press **HELP** with the cursor on any of the fields at the top of the screen to display the description of the selected alternate (after the field help screen).
 - The glideslope to the selected alternate is calculated identically to the alternates calculation above, using the current wind, MC setting, an arrival altitude of 500 feet (150 meters) AGL, etc.

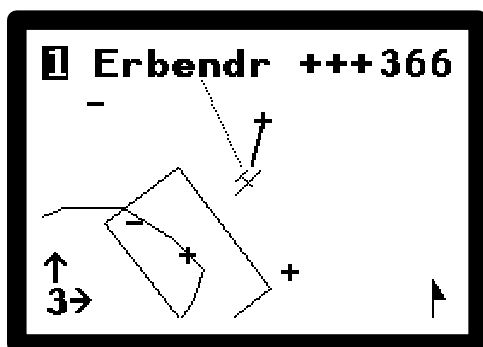

At left, the closest alternate **Erbendorf** has been selected (number **1** at top left). The pilot is **+++366** above glideslope. Erbendorf is a bit behind the glider, a solid line shows the route to Erbendorf, and the route home is displayed with a dotted line. Two other alternates are within reach (marked by "+" symbols), and a further two alternates are beyond reach ("- symbols).

WARNING

Alternates on the moving map are handled identically to the Alternates above, and subject to the same limitations and hazards. For your safety, make sure to study the [Club Alternates](#) above prior to using this feature.

7.4 Club Mode Wind Page

The SN10 automatically measures the wind speed and direction. You see the measured direction and strength, plus a wind-sock that shows the direction relative to your current flight direction (the windssock matches a windssock you would see on the ground, relative to the glider's orientation).

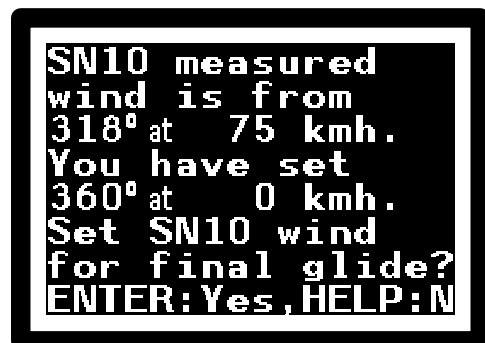
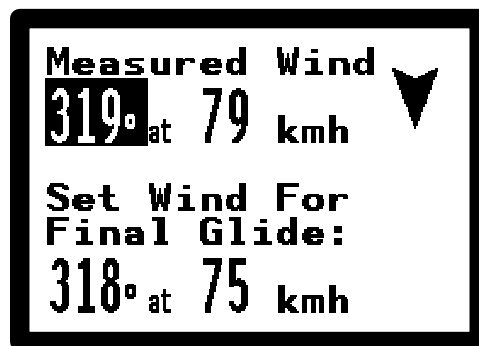

You, as pilot, must still decide what is a safe wind estimate for final glide. If the SN10 measures a wind that is very different from what is set for the final glide calculation, you will get this question.

This makes it easy to keep an appropriate wind setting for final glide.

7.5 Club Mode Setup

The SN10 options configured in *Competition Mode* are also used for *Club Mode*. Vario presentations, units, alternates displayed on moving map, sites, glider type, and other options should be configured in *Competition Mode* prior to flight.

The SN10 flight recorder operates automatically in *Club Mode* (see [Flight Recorder Page](#)). Retrieve the flight record using the PCLink (see [Download a Flight Record from the SN10 to a PC](#) below).

Some options are always reset each time the SN10 is turned on in *Club Mode*, especially the SN10 Standard Audio with standard damping, 150 meter arrival altitude, no water, and no bugs.

8 Assigned Area Task (AAT)

The Assigned Area Task replaces conventional fixed turnpoints with large areas within which you select your own turnpoints. In some countries, this task is also called the Turn Area Task (TAT) or Prescribed Area Speed Task (PAST). This chapter explains SN10 processing for AAT, which is significantly different than for normal (classic) tasks.

Enter the turn areas into the SN10, then adjust the actual turnpoint you plan to use within each of these areas. Use this feature to optimize your use of the available weather and time, both during pre-flight planning and during the flight. .

8.1 Entering an AAT Task

To enter an AAT task, change from Flight to Setup mode, turn to the [Task Rules page](#), and change the task type from **Classic** to **AAT** as depicted at right.

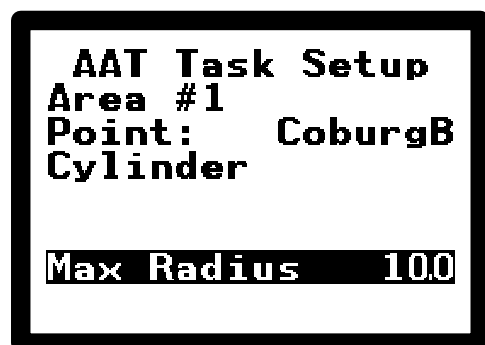
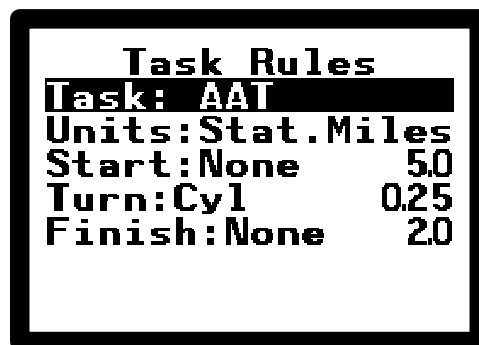

The AAT Task Setup page is available after you set the task type to AAT (this page is not visible when flying a classic task). Turn to the AAT Task Setup page, and enter the parameters of each area.

Select the number of the area to describe, and then select the point defining the area. Only points marked as “turnpoint” in the database will be available here. Do NOT select a point named “AAT Ptn” here !

To clear an area from the SN10, change the point to blank (spin **VALUE** counter-clockwise).

AAT areas may be simple cylinders (as shown above centered at Coburg), or a pie-slice wedge shape (shown at right). A pie-slice may also have a minimum as well as maximum radius. To enter a pie-slice, change **Cylinder** to **Sector**, and then enter the starting and ending radial (specified in a clockwise direction) and radius(s).

After entering the AAT task, change from Setup back to Flight mode.

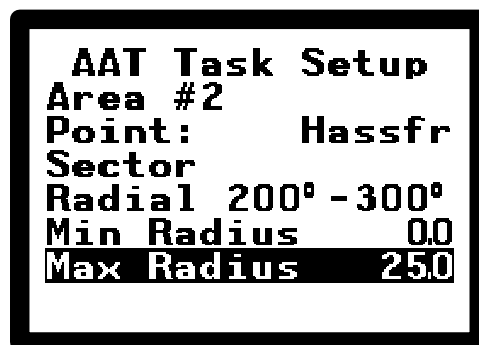

8.2 The Task Page in AAT Mode

After you enter an AAT task using the AAT Task Setup page, the Task page shows a list of automatically-created AAT turnpoints as shown at right. The ****AAT**** banner reminds you the AAT mode is selected. In AAT mode, you cannot change the turnpoints on the Task page (though you can adjust the start and finish points as always). To change an AAT task, you must use the AAT Task Setup page.

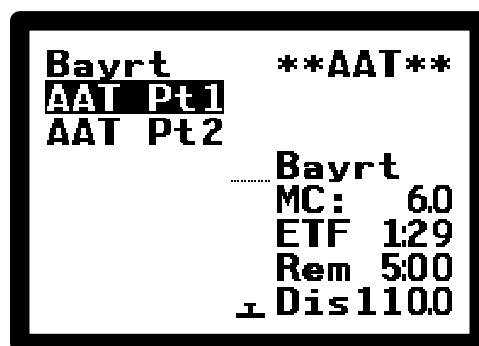

HELP for each AAT turnpoint repeats the area definition you entered on the AAT Task Setup page. As always, this help is available wherever the turnpoint is displayed.

8.3 Adjusting AAT Turnpoints

The moving map shows the area task described by the task entries above. The illustrated glider is sitting at the Bayreuth home point, the heavy line shows the first leg the center of the first turn area (Coburg), then on to the pie-slice at Hassfurt, and then home.

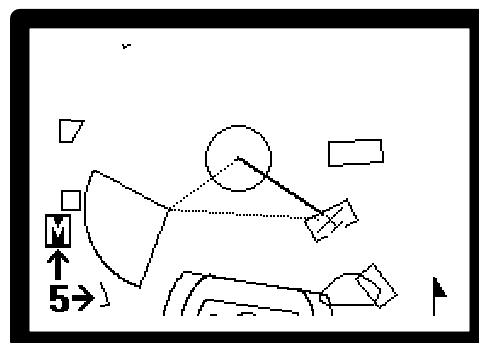

In AAT mode, a new field on the moving map controls the function of the map page. **M** is normal Map mode (shown above) - just as when a classic task is selected, the arrows scroll the map (up-down or left-right), and the number controls the scale (zoom).

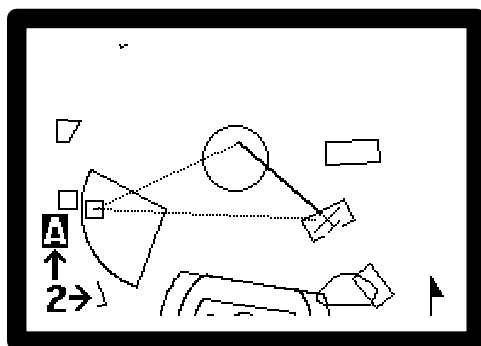

A is the AAT turnpoint adjust mode (shown at left), which allows you to move each planned turnpoint within the AAT area. Select which turnpoint you wish to move by changing the number at the lower left of the map (the exact center of the selected turnpoint will have a small box drawn around it on the screen). Move (drag) the turnpoint by placing the cursor on the up-down or left-right arrow and turning **VALUE**. At left, the turnpoint has been dragged from the apex of the sector to the left part of the Hassfurt area.

The SN10 uses the adjusted turnpoints for planning the task, including calculating ETF (Estimated Time to Finish) and final-glide around the turnpoints. Normally, you adjust the turnpoints on the ground for your planned flight. As you modify your plan during the flight, you may adjust the turnpoint locations in order to get updated ETF and final glide information.

8.4 AAT In Flight

When you fly into each AAT area on the task, the SN10 notifies you and gives you the opportunity to turn at this instant. If the weather is looking poor and it looks like you should turn now to shorten the task as much as possible, press **ENTER** and SN10 will mark and record that point then proceed on the next leg.



Normally, you will probably fly some distance into each turn area; in this case press **HELP** when you see this message. When you later decide to turn towards the next turnpoint, you must tell the SN10. Place the cursor on the turnpoint (for example **AAT Pt1**, on the task page, status page, or custom page), and press **ENTER**. The SN10 will update the present turnpoint to your current location, mark it 'achieved', redraw the moving map, and recalculate the ETF and final glide.

8.5 AAT Notes

Answers to a few common AAT questions:

- If you do not turn at the edge of the AAT area, the SN10 will not automatically notify you when you reach the planned turnpoint. You must tell the SN10 when you decide to turn.
- The SN10 creates automatic turnpoint entries in your database named **AAT Pt1** and so on. These points are automatically set whenever you create or edit an AAT. They will appear in your list of turnpoints but should be ignored. They can be deleted from the SN10 database if you like.
- Some contests use a final steering turnpoint, for example to ensure all finishers come from the same direction or to steer around illegal airspace. In this case, just enter an AAT cylinder area with the specified small radius.
- You can only change the AAT areas in SETUP mode. You should switch back to flight mode after entering an AAT to hide all the SN10 setup pages.

9 SN10 Installation

The performance of the SN10 depends on a high-quality installation. Please have this system installed and checked by a qualified mechanic, and ensure the guidelines suggested below are followed carefully.

9.1 Installation Preparation

Before installation, plan the installation carefully by reviewing the following points:

- **Is a fuse installed in the panel ?** A separate 1 Amp fuse for the SN10 is required; normally pilots prefer this to be installed in the panel where it is accessible. Use a second separate fuse for the GPS.
- **Is an external cruise/climb switch desired ?** Some pilots like the automatic 'G' sensing cruise/climb switching, but many prefer a switch on the flaps, the trim (non-flapped gliders), or the stick. Ensure the appropriate switches and wiring (shielded cable) are ready to install, and that the planned wiring routing cannot interfere with motion of flight controls.
- **Mechanical fit OK ?** Before cutting any holes, is there adequate space for the instrument and meters ? Check for interference between the instruments and the instrument panel (sides, top, bottom, and internal supporting structure for tilt-panels). Make sure to allow space in back of the SN10 for electrical and pneumatic connections. Note the SN10 is fractionally taller (87mm) than wide (83mm), and you will need some clearance to other instruments for the SN10 instrument case screws.
- **Will an external speaker be required ?** For most sailplanes this is not necessary, however for sailplanes with a well-sealed instrument panel or very loud sailplanes, it may be difficult to hear the speaker inside the instrument. We also recommend an external speaker be installed in the rear instrument panel for two-seat sailplanes. If you will install an external speaker, see [Installing an External Speaker](#) below; make sure to disable the internal SN10 speaker prior to installation; and add the required leads to either the main wiring harness or the two-seater cable prior to installation.
- **Temperature Probe access OK ?** The temperature probe needs to be installed where it can measure outside air temperature (and not the temperature of air sitting still in a warm duct). Plan the installation of the probe, and the probe wiring routing (especially so it cannot interfere with a nose release).
- **Motion OK for wiring ?** Make sure there is a safe routing for the wiring, so it cannot interfere with flight controls, or be stressed during operation of the tilt-panel.
- **Leak-Check kit ready ?** Make sure a proper leak-check test kit is ready to use (including couplers for testing pitot, static, and TE) before changing any flight-critical pneumatic connections.

- **Motor-Run Switch Input Needed ?** If this is a motor-glider installation and you wish to signal the motor on/off events in the SN10 flight record, provide a switch closure for motor-on. Add leads to the main wiring harness prior to any installation (see [Wiring Diagrams](#) below).
- **Will a Remote Control be used ?** The remote control is recommended for gliders with reclined seating where it is not easy to reach the panel, but it is not necessary for gliders with more upright seating like the Duo Discus. If you will use the remote control, make sure it can either be left plugged in to the connector on the left side of the SN10, or alternatively, ensure the panel cable will be located where it is convenient to plug in the remote for use during flight.
- **Where will the Panel Cable be installed ?** The panel cable will be used to connect a PC for loading a new database into the SN10, or for retrieving flight records from the SN10 to a PC. It can also be used to connect a remote control for use during flight. Plan a suitable location where a square cutout for the square end of the panel connector can be made, with space for the two mounting ears. Do not try to make a cut-out just for the DB9 portion of the connector, as this will usually result in the PC cable not seating completely (this has caused problems in a number of installations).
- **GPS installation and wiring planned ?** The SN10 is connected to a (single) GPS or flight recorder with NMEA output. Make sure to prepare the wiring (GPS to Panel Cable) before any installation (see [Wiring Diagrams](#) below).

9.2 Installing the SN10 Main Unit

Remove the knobs (pop off the colored knob covers with the edge of a knife blade or similar, then, slightly loosen but do not entirely remove the knob fastening screws). Remove the SN10 mounting screws from the top two holes, and the hollow mounting screws from the bottom two holes. Insert the SN10 into the panel.

CAUTION	When removing and tightening the on/off/volume knob, hold the knob with pliers in the half-volume position. You will break the switch if you twist against the stops of the switch when you loosen or tighten the knob's set-screw.
----------------	--

Ensure the instrument panel is flat where the SN10 contacts the panel. Tightening the mounting screws against an irregular surface applies great torque to the instrument and can crack the faceplate or glass.

If you have limited working space in the panel, you may want to remove the SN10 and ensure all electrical connections are completed, prior to mounting the instrument in the panel.

Replace the mounting screws at top and hollow screws at bottom. Tighten firmly, but take care not to over-tighten.

Reinstall the volume knob at the top (this knob has a larger shaft size). Reinstall the lower three knobs, taking care to allow adequate clearance between the knob and the instrument panel. Make sure the knobs are tight and cannot slip. Check when each knob is depressed fully it does not contact the hollow mounting screws or the panel (otherwise, the **HELP** and **ENTER** functions won't work).

9.3 Temperature Probe Installation

The temperature probe should be installed so it can accurately sense the outside air temperature. Many features of the SN10 rely on accurate temperature measurement, without which many functions will not work properly. A good location is at the very front of the nose inside the air intake.

Do NOT install the temperature probe inside an air vent duct with limited air flow. This will cause incorrect (high) temperature readings and result in improper operation of the SN10 (incorrect true airspeed and wind calculations).

Make sure the probe is not located where it can be damaged, and that the wiring cannot interfere with operation of a nose hook.

9.4 Pneumatic Connections

For the SN10, use the same pitot and static connections as you use for the airspeed, which should be per the aircraft manual. Using a non-standard pitot-static for the SN10 gives you an un-calibrated airspeed, which can result in improper SN10 operation.

Connect the TE to a good quality TE probe (we recommend ILEC's high quality TE probes). Do not use any gust filters or restrictors (small water traps are OK).

Conduct a complete leak check on the airspeed pitot, airspeed static, and TE. Locate and repair any leaks before returning the aircraft to service.

9.5 Electrical Connections

Note: Details for all electrical connections are found in the [Wiring Information](#) Appendix.

Connect power leads for the SN10 wiring harness (heavy red lead to fused +12v, and heavy blue lead to ground).

Connect the GPS TX/RX to the panel cable, and plug the panel cable into the right side (as installed) of the SN10.

If you are using an external cruise/climb switch, connect it to the blue/black pair from the main wiring harness. Please note switch closed means climb, and switch open means

cruise. Leave these leads disconnected if you are not using an external cruise/climb switch.

Connect the optional external speaker, and the optional motor run switch.

For a two-seater, route the SN10 two-seat cable between the front and back panels. Make sure to install the cable so the yellow and green meter leads exit the cable in the panel where you will install the SN10-2 repeater unit. Connect the two-seat cable 2nd seat side (again, the end with the meter leads) to the left side of the SN10-2. Connect the two-seat cable main unit side (no meter leads) to the left side of the SN10.

9.6 Installing the optional Remote Control

The remote control units can be plugged into any available DB9 connector. On the main SN10, connect to the panel cable or the left-side DB9. For two-seaters, use the panel cable in the front, and the SN10-2 right-side connector in the back. For two-seaters, make sure the two remote controls are different (make sure to tell your dealer one must be a second-seat remote control).

9.7 Installing an External Speaker

If an external speaker is required: Obtain a suitable external speaker (8 Ohms only, with a small magnet so as not to disturb the compass). Disconnect the SN10 (main unit) internal speaker (remove lower case, clip and tape speaker wire). Contact the dealer or the factory for assistance if required. Connect to either the main wiring harness DB15 connector or the two-seat cable rear DB9 connector (see [Wiring Information](#) below).

9.8 Guidelines for Pneumatic Plumbing

Sailplane pneumatic systems and variometers often perform poorly for a number of common reasons. Follow these simple guidelines to avoid trouble:

- Avoid use of old and stiff tubing. It often causes leaks at connections.
- Avoid use of extremely soft tubing such as surgical or latex types, as any motion or change in cockpit pressure will stretch the tubing and cause erroneous instrument indications.
- Do not leave long lengths of tubing unsupported. Any motion or G-load will cause the tubing to move, which will change its internal volume and cause erroneous instrument indications. Long pneumatic runs are best installed with hard nylon pressure tubing such as Imperial Eastman Polyflow 44-P-1/4.
- Avoid soft-sided gust filters (we recommend no gust filters be used). The gust filter capacity must be extremely rigid, or any change in G-load or cockpit pressure (such as from changing airspeed) will change its internal volume and cause erroneous instrument indications. If in doubt, turn on your instruments and

test by pressing gently on the capacity. If there is any variometer motion throw the gust filter in the trash immediately.

- When using multiple variors, minimize crosstalk by placing the T joint in the TE line as far from the variometers as possible. For example, put the T under the seat, and run separate tubes forward to the panel for the two variometers.

9.9 Guidelines for Electrical Wiring

We strongly recommend all wiring in a sailplane use shielded cables. Use of unshielded cable will greatly increase the likelihood of interference between the radio and the variometer systems. Wiring should always have the shield connected to ground AT ONE END ONLY. Wiring which should be shielded includes (especially) wiring for the radio microphone, push-to-talk, radio speaker, and CRUISE/CLIMB switch. Example high-quality shielded 2-conductor cable includes Dearborn Type 1022401 or Belden Type 9501. Avoid running wiring around or immediately adjacent to the radio or antenna lead.

This is a good time to check the glider's antenna connection to the radio. The crimp-on BNC connectors are sometimes installed improperly, which can cause poor radio reception and interference problems with other instruments.

The battery should be fused as close to the battery terminals as possible. The battery fuse is a fuse of last resort, and should be easily in excess of the requirements of your instrumentation. Several in-flight fires in sailplanes have resulted where a fuse was installed in the instrument panel only, and a short occurred between the battery and the panel (usually under the seat). Separate power wiring from the battery to the radio and to other instruments is recommended.

A secondary battery with independent wiring to a selector switch on the panel is highly recommended, due to the tendency of batteries to fail during the most important flight of each season. Panasonic, Dry-Fit, or Powersonic 6.5 Amp hour (or higher) 12 volt gel cell or sealed electrolyte types are recommended (14 volt batteries provide no advantage for the SN10). The Minus terminal of each battery should always be connected to the sailplane ground and should never be switched. Never connect the Plus terminals of more than one battery together.

Power wiring should use 18 gauge or larger wire. Avoid use of inexpensive automotive switches, connectors, and fuse-holders. These are prone to contact corrosion leading to problems in operation of the sailplane instruments. The battery voltage indicated by the SN10 should be no more than .2 volts less than the voltage measured at the battery terminals (with a high quality voltmeter). If the difference is more than .2 volts, check the voltage drop across each segment of the electrical wiring until the high resistance components are located (usually oxidized connections, switches, or fuses), and repair.

9.10 Installation Checklist

After completing the SN10 installation, please review these two checklists prior to returning the aircraft to service.

9.10.1 Safety Check Before First Flight

- All controls, canopy hinges, tilt-up instrument panels, tow release, rudder adjusts, and all other mechanisms checked for no interference with the SN10 wiring or pneumatic runs. There must be absolutely no possibility of interference between any instrument components and the pilot or sailplane flight controls.
- The GPS and GPS antenna installation must not interfere with canopy jettison.
- Pneumatic system checked for leaks, including pitot, static, and TE.
- Airspeed and Altimeter are functioning correctly.
- Variometers functioning properly.
- Proper fuses installed (at battery, for SN10, and for GPS).
- If installed, check proper operation of [Cruise/Climb switch](#). Verify the *External Switch* option is selected on the [SN10 Options 1 page](#), turn up the audio, and cycle the cruise/climb switch (the audio should come on and off if *SN10 Standard* audio is selected).
- Battery voltage indicated by SN10 (on the [Vario Tuning Page](#)) is no more than .2 volts less than the voltage measured at the battery terminals (with a high quality voltmeter). If the difference is more than .2 volts, check the voltage drop across each segment of the electrical wiring until the high resistance components are located, and repair.

9.10.2 SN10 Configuration Check Before First Flight

- Audio style selected (we recommend SN10 standard). See [Audio Setup](#) above.
- Vario meter display choices entered. If there is any confusion about which meter is #1 etc; try changing the selection and see which meter moves (note that depending on whether the SN10 is in CRUISE or CLIMB, only one set of selections will cause the meters to move). See [Variometer Choices](#) above.
- Units selected per pilot preference. See [Units Setup](#) above.
- Glider polar selected, and both water capacity and empty (dry) gross weight for this particular sailplane and pilot entered. See [Glider Polar Setup](#) above.
- Options pages completed. We recommend reviewing all settings on the *SN10 Options 1* page, *SN10 Options 2* page at this time. See [SN10 Options 1 Setup](#) above.
- Set the SN10 to your local date and time.
- Initial database loaded into SN10 from a PC.
- Set *Flight Recorder* options including competition ID and pilot.

Appendix A: Frequently Asked Questions

Q: The **HELP** (or **ENTER**) button doesn't work !

A: This is caused when the push-button travel is limited because the knobs are too close to the panel. Loosen the knob, adjust it away from the panel, and tighten securely. When you press in the button, it must not contact the panel or the hollow mounting screw !

Q: I downloaded an NDB file from the World-Wide Turnpoint Exchange using Internet Explorer, and it won't load into the SN10 !

A: Windows and IE cause a number of problems when you try to download a file. Either use Netscape, or follow the instructions on the Web site, or follow the instructions above: see [Using Prepared Site Database Files \(NDB files\)](#).

Q: The time in flight resets to zero !

A: On the Timers page, set the time to your local time (if you leave it set to German time, the statistics get reset when the clock passes midnight during the flight).

Q: How come my SN10 switches between cruise and climb when it shouldn't ?

Q: Why doesn't automatic switching between cruise and climb work smoothly ?

A: Automatic switching between cruise and climb has a short delay (it must, otherwise it would drive you crazy jumping back and forth). If the SN10 switches when it should not, or doesn't switch when it should, check and adjust the G-meter; for instructions see [Raw Sensors Diagnostic Page](#) above.

Q: Why isn't the final glide wind set automatically from the measured wind ?

A: The wind in front of you is not necessarily the wind we measured behind you. Please read the discussion about this in [The Measured Wind Page](#) above. We know of at least one accident where a pilot did not think about the wind in front of him (he was using an older computer which automatically set the final glide wind from the measured wind).

Q: Why are there no numbers on the heightband page ?

Q: Why isn't more stuff shown on the moving map ?

A: We try to make it easy to get the information you need in a quick scan. If we put more on the screen, it becomes much harder to scan this quickly, and increases heads-down time.

Q: Why is there so much stuff on the status page ?

A: We placed all the in-flight settings that influence the final glide on the right hand side of the status page, with the navigation information on the left. This page really reduces page flipping. If you find it too busy, use the custom page !

Q: Why won't my PC talk to my SN10 ?

A: Check all power-saving features are disabled on your laptop, make sure no programs are contending for the serial port (like Palm's Hotsync), make sure all other DOS boxes are closed. Finally, if you are using Windows 98 or Me, see the section above on [Communication Problems with Microsoft Windows 98](#).

Q: Why am I getting lower performance than the SN10 expects on final glide (I keep ending up lower than I expect) ?

A: Make sure you have the correct polar selected, and the weight for your glider (including your weight and ready to fly without ballast) is set correctly.

Q: Why can't I select any turnpoints for my task ?

A: When you prepare a database for use with the SN10, make sure you set the *Turnpoint* attribute for all points you wish to use as turnpoints. Alternatively, use [Touring Mode](#), in which all airports are available as turnpoints.

Q: Why am I getting "No GPS Input" warnings ?

A: When you plug in the PC cable, the GPS input is disabled. Make sure to unplug the PC cable after you load new software or use PCLink.

Appendix B: Suggested Pre-Flight Checklists

We suggest the following for your pre-flight checklist (prior to every flight).

Competition Mode Takeoff Checklist

- Verify altimeter setting **Alt**. The SN10 will try to locate your takeoff point in the database and set the altimeter automatically, but please check.
- Set desired finish altitude in the **Fin** field (field elevation plus safety height).
- Check Battery Voltage **Volts** (on the *Vario Tuning* page, make sure your battery is properly charged).
- Set timers if applicable (**STI** start time interval, and **PST min** pilot-selected-task minimum time). To suppress the STI warning “You have 10 minutes remaining n your Start Time Interval”, set the STI interval to 0.
- Set the final glide **Wind** setting from the weather briefing.
- Set **Water** and **Bugs**.
- Set the planned **Task**, or your initial plan for a pilot-selected task.
- **“Task Rules” page:**
 - USA Contests: verify units for task rules set to “Statute Miles”.
 - USA GPS Start: Set Start to ‘Cylinder’ and set cylinder size.
 - USA GPS: Verify Finish type and size is set correctly.
 - USA Contests: Verify .25sm (.22nm, .40km) Turnpoint **Cylinder** Size.
 - Non-USA: Verify turnpoint **Cylinder** size

Club Mode Takeoff Checklist

CAUTION	<p>If you turn off the SN10 you will lose some settings. Each time you turn on the SN10 it will reset some settings to their default value, including the desired arrival altitude (this is only on the ground; no settings will be changed if you turn the SN10 off and on during flight). Do not turn off the SN10 after you done your checklist, or you will have to do the checklist again before you launch.</p>
----------------	--

CHECKLIST

- Verify the altimeter setting **Alt**. The SN10 will try to locate your takeoff point in the database and set the altimeter automatically, but please check.
- Set desired arrival altitude over the ground in the **Arv** field. The default is 150 meters (500 feet); increase this if you wish a larger arrival altitude.
- Set **Water** and **Bugs** (on the *Club Settings* page).
- Check Battery Voltage **Volts** (on the *Club Settings* page, make sure your battery is properly charged).
- Set the final glide **Wind** setting from the weather briefing (on the *Club Wind* page).

Appendix C: Specifications

Mechanical Specifications

The mechanical layout and dimensions of the SN10 (front view) follows:

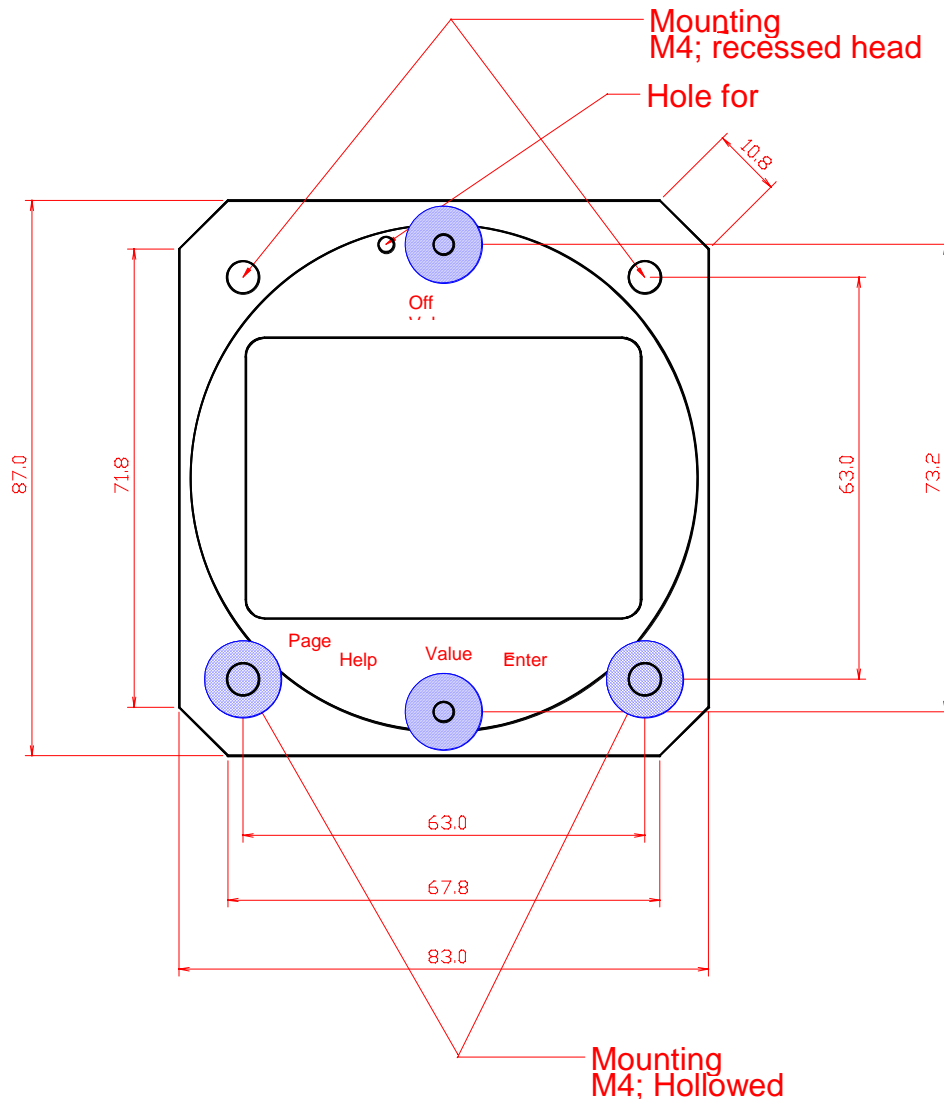

The emergency reset should never be necessary, and should be used only after instructions from ILEC. To operate the emergency reset, take a paper clip and straighten 2" of it. Gently insert the straightened end of the paper clip into the small reset hole just **left** of the volume knob on the main SN10 instrument. Press in gently and you will feel a small switch click. While holding in the paper clip, turn on the main SN10. The SN10 will then restart.

The mechanical dimensions of the SN10 and it's options are:**SN10 (main unit)**

80 mm (3 1/8 inch) standard cut-out;

85 x 89 x 160 mm (width x height x depth);

In addition to the 160 mm depth of the main unit you will need an additional 45 mm depth for the electric and pneumatic hook ups at the rear (lower half) of the instrument

SN10-2 (two seat repeater)

80 mm (3 1/8 inch) standard cut-out;

85 x 89 x 85 mm (width x height x depth);

In addition to the 85 mm depth of the main unit you will need an additional 45 mm depth for the electric and pneumatic hook ups at the rear (lower half) of the instrument

RAZ (external meter)

57 mm (2 1/4 inch) standard cut-out;

62 x 62 x 50 mm (width x height x depth);

Panel Cable

The panel cable may be installed anywhere in the front panel;

size: 32 (53 for mounting) x 15 mm , depth 40 mm;

recommended panel cutout 15 x 33 mm rectangle

General Specifications

Power Supply:	10 - 15 DCV
Current (volume off / full):	about 100 / 150 mA at 12 V (without GPS) about 250 / 300 mA at 12 V (with ILEC-supplied GPS)
Housing, Main Unit:	Ø 80 mm standard cut off in instrument panel required, 85 x 89 x 157 mm (without adapter)
Temperature Range:	-20 to +60 °C
Weight	about 0.7 Kg
Static Pressure Transducer	280 to 1045 hPa (about MSL to 9500m)
Pitot Pressure Transducer	1 to 45 hPa (about 45 to 310 km/h)
Variometer	+/- 15 m/s

Appendix D: Wiring Information

The following photo shows the components and wiring overview for the SN10:

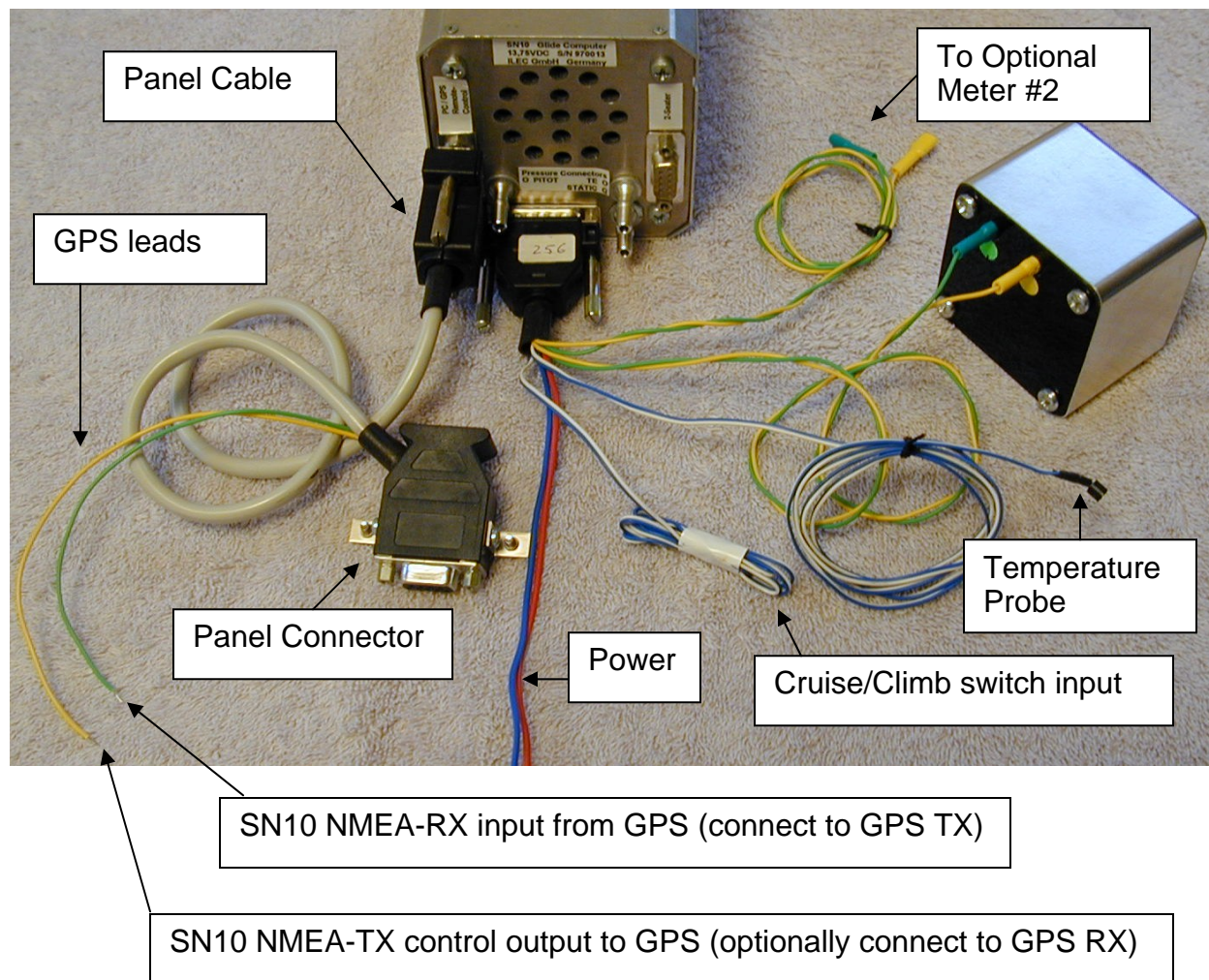

The 2-seat SN10 is cabled as follows:

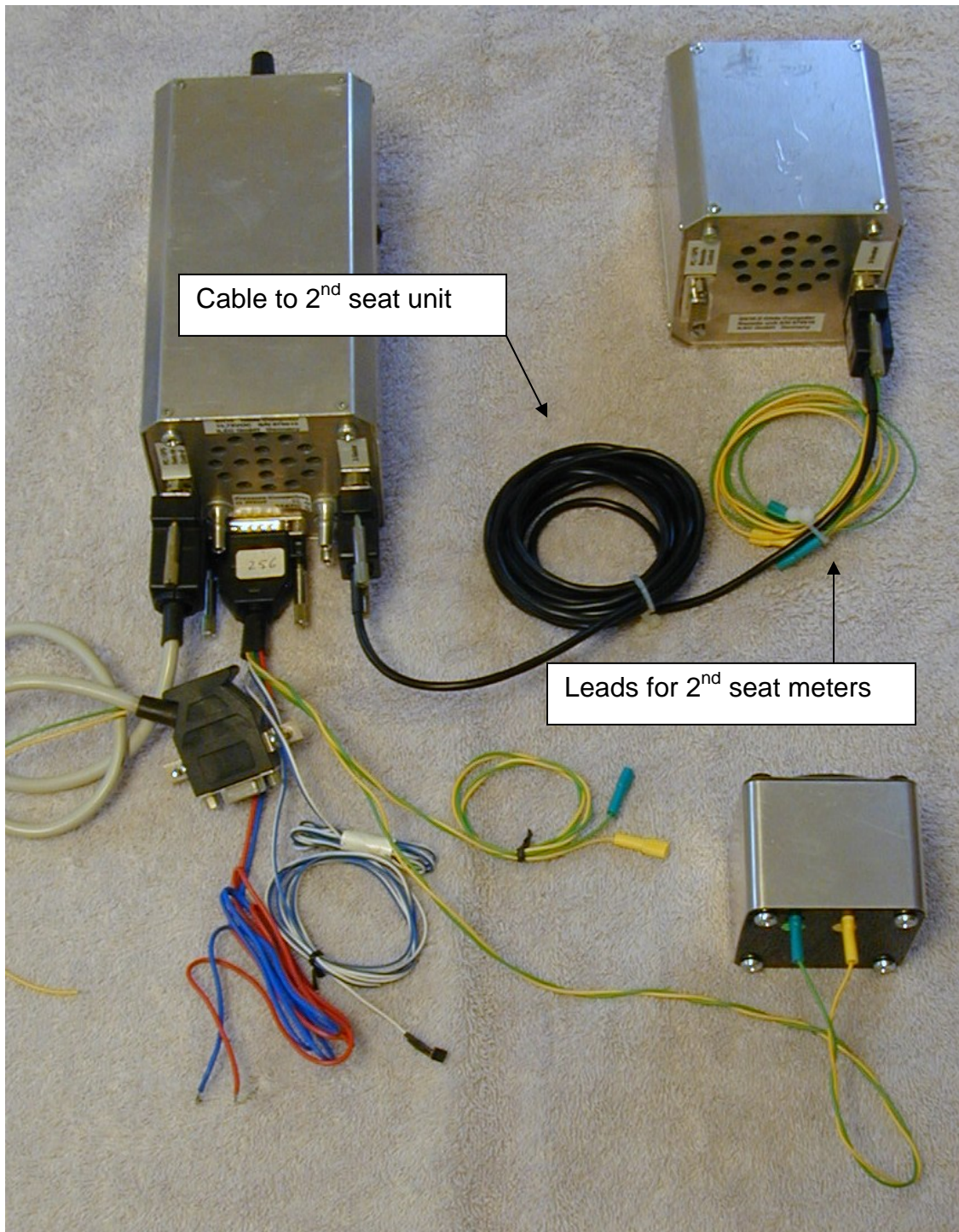

The SN10 has three electrical connectors at the rear of the instrument. Their connections, and also the color codes for the ILEC-supplied cables follows.

Main SN10 Connector (15-pin, DB15 female, bottom)

Pin No.	Description	Supplied Wiring Harness Color
1	External Temperature	white of blue/white cable
2	Ext. Temperature GND	blue of blue/white cable
3	External Speaker GND	NC
4	Cruise/Climb Switch GND	blue of open-ended blue/white cable
5	Cruise/Climb Switch Switch closed indicates CLIMB	white of open-ended blue/white cable
6	Ext. Switch B	NC
7	Turnpoint Camera switch input	NC (ground to pin 4 at photo)
8	Motor Run switch input	NC (ground to pin 4 for motor run)
9	External Speaker	NC
10	+12 V Battery via 1 amp fuse	red (thick cable)
11	GND Battery	blue (thick cable)
12	Meter 1 or 2 analog ref	Green
13	Meter 1 or 2 analog ref	Green
14	Meter 2	yellow (labeled 2)
15	Meter 1	yellow (labeled 1)

If you wish to use an external speaker, wire it to pins 9 and 3 (see [Installing an External Speaker](#) above).

To signal motor-run to the SN10, provide a connection to ground on pin 8 (do not apply any positive voltage input on this pin). This feature will record motor start and stop events in the flight record.

PC/GPS and remote control (serial numbers to xx0099)

Please note: Pin assignments and panel cable wiring are different for SN10s with serial numbers up to xx0099, and SN10s with later serial numbers. This section describes serial numbers up to xx0099. The PC/GPS and remote control connector is a 9-pin DB9 female, on the glider right side.

CAUTION	A Gray Panel cable will not work with SN10s serial numbers up to xxx0099. The panel cable for use with an SN10 serial xxx0099 or lower has a black cable housing.
----------------	--

Serial numbers up to xxx0099 only (later serial numbers see next section)

Pin No.	Description	Supplied Black Panel Cable External Lead Color
1	12 V switched for GPS (Volkslogger or Garmin GPS-35 only), absolute maximum peak current 100ma. CAUTION: Absolutely not for use with Cambridge flight recorders. CAI flight recorders draw too much power-on current and will damage the SN10.	Red
2	TX out to PC / GPS	Yellow
3	RX in from PC / GPS	Green
4	Do NOT connect this Pin	
5	GND	Blue
6	5V power supply to remote control	
7	B-Data; SN10 data bus	
8	A-Data; SN10 data bus	
9	GND	

The ILEC-supplied Panel Cable should be connected to the PC/GPS connector on the SN10. Wire your GPS's NMEA output to green, your GPS's NMEA input to Yellow, and the GPS signal ground to Blue. If you are using a Garmin GPS-35 or a Volkslogger, you can use the red-blue pair to power the GPS (the GPS will be switched on when you turn on the SN10). For other GPS types, you must use a separate power source (many types draw too much power on startup and will damage the SN10, especially Cambridge flight recorders).

PC/GPS and remote control (serial numbers xx0100 up)

Please note: Pin assignments and panel cable wiring are different for SN10s with serial numbers up to xx0099, and SN10s with later serial numbers. This section describes serial numbers xx0100 and later. The PC/GPS and remote control connector is a 9-pin DB9 female, on the glider right side.

CAUTION	A Black Panel cable will not work with SN10s serial numbers xx0100 and later. The panel cable for use with an SN10 serial xx0100 and later has gray cable housing.
----------------	---

Serial numbers xx0100 and later only (earlier serial numbers see previous section)

Pin No.	Description	Supplied Gray Panel Cable External Lead Color
1	12 V switched for GPS (Volkslogger or Garmin GPS-35 only), absolute maximum peak current 100ma. CAUTION: Absolutely not for use with Cambridge flight recorders. CAI flight recorders draw too much power-on current and will damage the SN10.	*Red
2	TX out to PC / GPS	Yellow
3	RX in from PC	
4	Relay switch input Ground to disable NMEA input.	
5	GND	*Blue
6	5V power supply to remote control	
7	B-Data; SN10 data bus	
8	A-Data; SN10 data bus	
9	RX in from GPS (NMEA GPS input)	Green

The ILEC-supplied Panel Cable should be connected to the PC/GPS connector on the SN10. Wire your GPS's NMEA output to green, your GPS's NMEA input to Yellow, and the GPS signal ground to Blue. If you are using a Garmin GPS-35 or a Volkslogger, you can use the optional red-blue pair to power the GPS (the GPS will be switched on when you turn on the SN10). For other GPS types, you must use a separate power source (many types draw too much power on startup and will damage the SN10, especially Cambridge flight recorders).

** Make sure the external GPS is grounded to glider battery or SN10 ground.

Connector for Two-seater repeater (9-pin, DB9 female, left)

Pin No.	Description	Supplied Two-Seat Repeater Cable External Lead Color
1	12 V switched	
2	Meter 1	Yellow (labeled 1)
3	Meter 2	Yellow (labeled 2)
4	Meter 1 and 2 analog ref	Two Green leads
5	GND	
6	5V power supply for remote control	
7	SN10 data bus (B-Data)	
8	SN10 data bus (A-Data)	
9	External Speaker	

With the SN10 repeater instrument for the 2nd seat in a two-seat glider, ILEC provides a two-seat repeater cable. The cable end with the external meter leads (yellow and green) must be connected to the 2nd seat repeater (left side of the repeater instrument), while the other end of the cable is connected to the main SN10 unit (left side of the main instrument).

The yellow and green leads are connected to the external meter or meters, just like the main SN10 unit.

You can connect an external speaker at the 2nd seat unit using pins 9 and 5 if you disable the main unit's internal speaker (see [Installing an External Speaker](#)).

Panel Cable and PC Cable Diagram

Cockpit Panel Cable

PC Cabling

SN10 Cockpit panel cabling S/N xxx001 to S/N xxx099

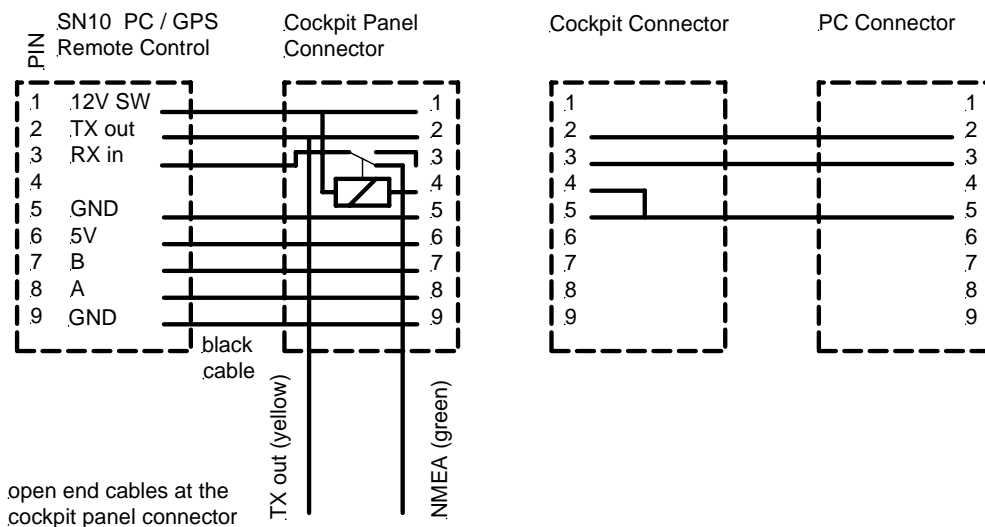

SN10 Cockpit panel cabling from S/N xxx100 up

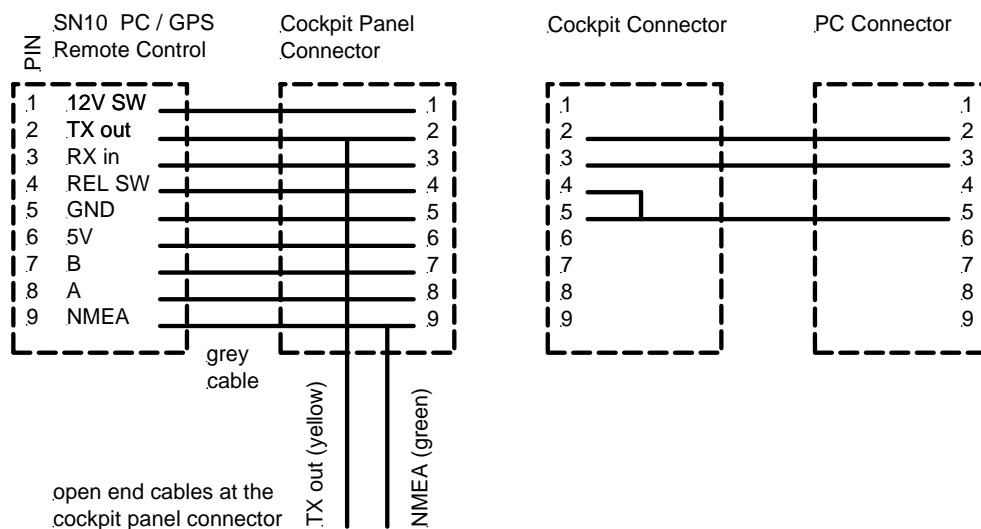

SN10 to Volkslogger RJ-45 Wiring

This wiring diagram applies to newer volksloggers using the RJ-45 connector (this connector looks like a computer network cable or a big telephone connector). For older Volksloggers with the round connector, please consult the Volkslogger manual.

Hold the connector clip side down, with the cable to the bottom. Pin 1 is at the left.

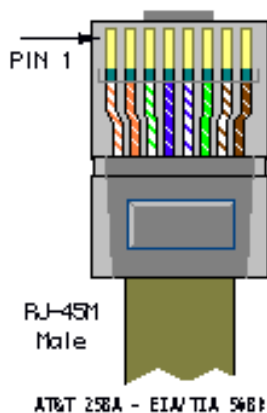

If you have a cable with standard computer network color coding, the colors will match this diagram and the table below. If not, carefully use the pin numbers to determine the correct connections.

RJ45 pin	RJ45 color	VL function	SN10 color	SN10 Panel Cable Pin at SN10 DB9 connector
1	White-Orange	Ground		
2	Orange	Ground		
3	White-Green	serial input	yellow	2
4	Blue	NMEA output	green	9 (except 3 thru #99)
5	White-Blue			
6	Green			
7	White-Brown	+12		
8	Brown	+12		

SN10 to Cambridge Aero Instruments Flight Recorder Wiring

The CAI flight recorder uses a 6-wire telephone-style cable for the NMEA data connection, routed through big black ferrite lumps to try preventing radio noise escaping the CAI equipment. This telephone cable has a standard color code. Take the CAI “data” cable, and hold one of the ends with the connector oriented as below (connector to your right, locking tab down, cable to the left). If the color of the wire closest to you isn’t blue, try the other end. Cut the cable in half, and discard the end that doesn’t have the blue wire oriented as shown. Connect the telephone cable to the SN10 panel cable per the table below. Note: If you don’t have the blue wire oriented as below, the color codes below won’t work !

SN10 Panel Cable	Signal	CAI Color
		Blue
Yellow	NMEA →	Yellow
		Green
Green	← NMEA	Red
		Black
Blue	GND	White

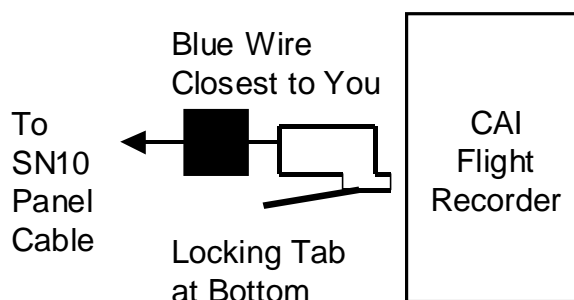

Appendix E: Using The SN10 Without GPS

GPS receivers are extremely inexpensive, and most pilots will choose to connect their SN10 to a GPS. However, the SN10 is capable of functioning in a limited fashion without a GPS. To use the SN10 without GPS input, you must disable the GPS input (on either the [GPS page](#) or the [SN10 Options / page, GPS Type](#)). If there is an in-flight GPS failure, disable the GPS functions by selecting GPS “Off” on the [GPS page](#) and then use the SN10 as described below.

With GPS disabled, the SN10 can perform dead-reckoning navigation and wind estimation, with the following differences:

- No GPS wind page.
- The SN10 depends on you to set a task, and an initial wind estimate. It will perform dead-reckoning assuming you are flying approximately on course using MacCready-theory speeds.
- When arriving at a turnpoint, you must tell the SN10 the glider has achieved the turnpoint by pressing **ENTER** with the cursor on the turnpoint, or optionally, by pressing an external camera button. This fixes your position at the turnpoint.
- When you give a position fix, for example at a turnpoint, the SN10 will estimate the wind.

Position Tracking During The Task without GPS

Without GPS, the SN10 estimates the glider’s position during the flight. While flying along each leg the distance to the next turnpoint (*Out*) will count down and the distance left or right of course will change.

The SN10 continually estimates the glider's position by integrating airspeed and heading, where heading is estimated based on the current leg. The SN10 assumes you are flying on course with an appropriate crab angle for the wind, and that the glider drifts with the wind while circling.

You must periodically update the glider’s position in the SN10 to reflect your actual location and remove any accumulated errors, especially if you make any large deviations (see the next section for a discussion of how to update your position). As described below, updating your position will also help keep an accurate picture of the wind, which will in turn allow the SN10 to track the glider’s position more accurately.

Before starting a task, always set an initial wind direction and strength based on your weather briefing and your best initial estimate.

Flight Segments for No-GPS Wind Estimation

In the simplest case, each time you round a turnpoint, the SN10 recalculates the wind. If you make no large deviations and set a reasonable initial wind estimate, the SN-10 wind estimate will be remarkably accurate. You will get the best estimated wind when this procedure is repeated on multiple task legs (or leg segments) with very different headings, and where the segments are long (such as a complete task legs, or periods over 20 minutes).

No-GPS Position and Wind Calculations During the Task

Flying along a course leg, you should periodically check your position, and if required, adjust the distance to the next turnpoint (*OUT*) and the distance left or right of course. When you update your position, the SN10 recalculates the wind direction and strength to match the revised position. Similarly, adjusting the wind will cause the SN10 to update your estimated position. These wind and position calculations are based on the distance and direction flown through the air since your last position fix, described below. If the initial wind is reasonably close and you fly on the course, no adjustments will be required.

Position Fixes (No-GPS)

Telling the SN10 your exact position is referred to as *giving a position fix*. Each position fix restarts the SN10's wind calculation and eliminates any accumulated dead-reckoning errors. To give the SN10 a position fix, adjust the distance out and distance left or right of course, then (with the cursor on either the distance out or distance left or right of course) press **ENTER**. Normally, you adjust the position, the SN10 adjusts the wind, and you fix the position by pressing **ENTER**. If you wish to reset the position without the SN10 changing the wind, press **ENTER** with the cursor on distance out or left/right before adjusting the position. If you believe you have a better estimate of the wind ahead than the SN10 has calculated, correct the wind after the position fix. For best wind estimation results, give position fixes only when absolutely required, ideally just at turnpoints as described below.

Arriving at a Turnpoint (no-GPS)

Upon arriving at a turnpoint, you should inform the SN10 and fix your position at the turnpoint. If you are using cameras and have the optional turnpoint camera switch wired to the SN10, taking a picture tells the SN10 you are at the turnpoint. Otherwise, place the cursor on the turnpoint name (either on the task page or on the status page) and press **ENTER**.

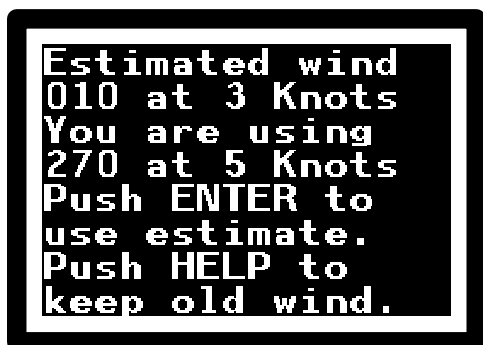
A screenshot of the SN10's monochrome display. The text is white on a black background and reads: "Estimated wind 010 at 3 Knots", "You are using 270 at 5 Knots", "Push ENTER to use estimate.", and "Push HELP to keep old wind." The text is arranged in four lines, with the first line being the longest and the last line being the shortest.

```
Estimated wind
010 at 3 Knots
You are using
270 at 5 Knots
Push ENTER to
use estimate.
Push HELP to
keep old wind.
```

Pressing **ENTER** with the cursor on the turnpoint name or using the optional turnpoint camera switch fixes your position at the turnpoint. The SN10 will ask if you wish to use the newly estimated wind, or if the wind you had previously entered should be preserved. Avoid using the newly estimated wind if you made any significant detours since the most recent position fix.

After you inform the SN10 you have arrived at the turnpoint, it will start tracking the next leg of the task. The next turnpoint name will be displayed on the status page, along with the compass heading and distance to the next turnpoint. Re-photographing a turnpoint with the optional camera switch does not cause problems; the SN10 will reset your position to the current turnpoint rather than advancing to the next turnpoint.

Appendix F: Quick Setup Guides

To quickly configure your SN10 for the specific use described, set your options to match the following pages. Please see [Appendix B: Suggested Pre-Flight Checklists](#) for pre-flight checklists.

USA Nationals

Here are the most common settings for USA National Competitions (regional competition rules may vary). Set statute miles for distance or your task distances will not match the scorer. Always set the units on the Task Rules page to statute miles, and set the turnpoint cylinder radius to .25 statute miles. Start and finish types and sizes may be changed each day in USA contests; take care that these are set correctly.

Units	
Height:	Feet
Dist:	Stat.Miles
Speed:	Knots
Climb:	Knots
Celsius	
Gallons	1/1000s
lbs	"Hg

Task Rules	
Task:	Classic
Units:	Stat.Miles
Start:Cyl	5.0
Turn:Cyl	0.25
Finish:Cyl	5.0

Badge Flights

For badge flights, please consult the FAI rules and/or rules from your national governing body. Typically, you will need to set start and finish to either "line" or "FAI sector," and set turnpoints to "FAI sector." FAI rules do not limit the size of the sector, so set a suitably large enough size to make the sector convenient to use.

Appendix G: Using the SN10 with a Volkslogger

The SN10 can automatically transfer the task to a Volkslogger flight recorder. With the Volkslogger off, set your task in the SN10. When you have finished entering the task, plug in the Volkslogger. The SN10 will ask if you want the task loaded into the Volkslogger. Press **ENTER** promptly, and the SN10 will send the task information to the Volkslogger.

NOTE

- You must press **ENTER** within a few seconds of receiving the “Do you want to download the task to the Volkslogger” question, or this won't work.
- Requires Volkslogger firmware version 1.73 or later. If your Volkslogger has an older firmware version, contact your dealer for a Volkslogger software upgrade.
- The SN10 transfers the home airport, task start point, task turnpoints, task endpoint, turnpoint notification style (FAI sector or cylinder), pilot name, contest ID, and glider type to the Volkslogger. Other information you must enter directly into the Volkslogger (glider ID etc.).
- The SN10 will not transfer the SN10 database to the Volkslogger. The SN10 transfers only the information about the task selected in the SN10 when the Volkslogger is connected. To use the task planning and other features of the Volkslogger, you must configure the Volkslogger with a PC (see the Volkslogger manual for details, or StrePla or SeeYou software).
- If you change the task after transferring it to the Volkslogger, the above process must be repeated. The SN10 cannot transmit task changes to the Volkslogger while in flight, due to IGC security requirements. In any case, your flight will be recorded in the Volkslogger, even if the declared task doesn't match the flight.

Appendix H: Warranty and Repair

ILEC Manufacturer's Warranty

All ILEC products come with a 2 year warranty covering failures in material and manufacturing of the product. ILEC will replace or repair parts of the instrument which have failed in the warranty period, provided the instrument has been returned free of charge, and provided it had been operated within the limits specified in this manual. In particular, no warranty can be claimed, where any liquid (e.g. water) or foreign particles have been allowed to penetrate into the pneumatic ports.

ILEC cannot be held responsible for consequential damages caused by a failure of the instrument, or any other cause that might be connected with the instrument.

Returning an Instrument to ILEC for Repair

In case of trouble, describe the problem as precisely as possible, so the instrument can be repaired as quickly as possible. Please give a phone number and email address where you can be reached, in case of questions about the problem you've encountered.

Tape your name, return address, and contact information to the instrument case. Pack the instrument carefully, ensuring no foreign particles or liquid can penetrate into the pneumatic ports. Seal the instrument in two layers of plastic bag, then pack with a thick layer of protective material.

Ship to (don't forget the telephone number on the address):

**ILEC GmbH
Friedrich-Puchta St. 6
D-95444 Bayreuth
Germany**

Telephone (0921)13733

NOTE

- On the customs slip, clearly mark:
 - Civil Aircraft Instruments for Repair TARIC 8803 90 91
 - value 200 Euro.
- From outside Europe: Please ship via Airmail service and if possible specify "letter airmail" (not "parcel airmail"). **Do Not use UPS, FedEx, or Express mail**, as this is actually slower (your instrument will sit in Frankfurt customs for days).

Index

Assigned Area Task	59
Audio	
Choices, Interpretation	24
Speaker	see Speaker, external
Volume.....	see Controls, Volume
Averager, different types available	26
Battery Voltage	
Measured.....	17
Required	74
Controls	
Emergency Reset	73
HELP and ENTER buttons.....	2
PAGE, CURSOR, and VALUE knobs	2
Volume.....	2
Volume, increasing with speed	24
Cruise/Climb Switching	32, 69
Data Logger	see Flight Recorder
DBC (DataBase Check program for NDB files)	48
ETF (estimated time to finish the task).....	4, 5
Fin (final glide finish altitude).....	7
Flight Recorder	
Download a flight record to a PC	47
General Information	40
Fuse	
Battery	66, 67
SN10.....	62, 77
GPS	
Alerts for GPS malfunction.....	14
Blinker	14
Failure in flight	84
Mark Position	14
Logger	see Flight Recorder

OAT (Outside Air Temperature) 17

Position fix, no-GPS operation 85, 86

Remaing PST time (Rema) 4, 15

Setup Mode, how to select 17

Speaker, external 62, 65, 77, 80

Statistics 16

STI (Start Time Interval) 6, 15

TAT 59

Turnpoint
 Rounding without GPS..... 86

Turnpoint camera photo switch 31, 77, 85

Variometer
 Scale 17
 Speed and Damping 17
 Types of possible meter display..... 25

Volume see Controls, Volume

Wind Estimation without GPS 86