

## General Description

The AOZ1321DI is a P-channel high-side load switch with controlled slew rate. Three slew rate options are available. The AOZ1321DI-01L and AOZ1321DI-04L have slew rates of 800 $\mu$ s. The AOZ1321DI-02L and AOZ1321DI-05L feature fast Slew Rate (less than 1 $\mu$ s). The slew rate of AOZ1321DI-03L and AOZ1321DI-06L is 100 $\mu$ s. The AOZ1321DI-03L, AOZ1321DI-04L, and AOZ1321DI-05L provide an output discharge circuit to quickly discharge the output when the switch is disabled.

The P-channel MOSFET has typical on resistance of 60m $\Omega$ . The very low  $R_{DS(ON)}$  significantly reduces the power path dissipation. The input voltage range of AOZ1321DI is from 1.6V to 5.5V. The control input is compatible with both TTL and CMOS logic. Ultra low quiescent current makes this product suitable for any portable applications.

The AOZ1321DI is available in 4-pin 1.2x1.6 DFN package and is rated over the -40 $^{\circ}$ C to +85 $^{\circ}$ C ambient temperature range.

## Features

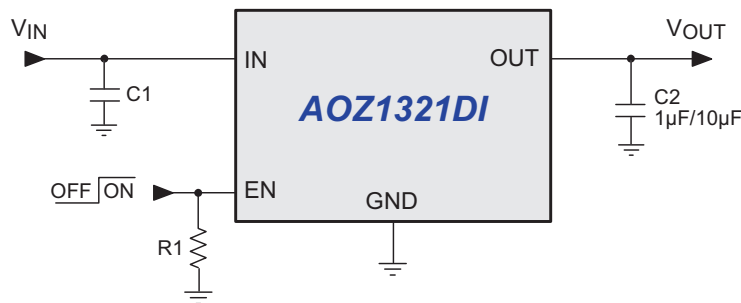
- 1.6V to 5.5V input voltage range
- Low  $R_{DS(ON)}$  (60m $\Omega$  typical at 5V)
- Controlled turn-on slew rate
  - 800 $\mu$ s (AOZ1321DI-01L, -04L)
  - 100 $\mu$ s (AOZ1321DI-03L, -06L)
  - 1 $\mu$ s (AOZ1321DI-02L, -05L)
- Output discharge function (-03L, -04L, -05L)
- Low quiescent current (1.0 $\mu$ A typical)
- Low shutdown current (<1 $\mu$ A)
- 4kV ESD Rating
- Tiny 1.2x1.6 DFN package

## Applications

- Cellular phones
- MP3 players
- Personal media players
- Notebook computers
- Digital still cameras
- Hot-swap applications



## Typical Application



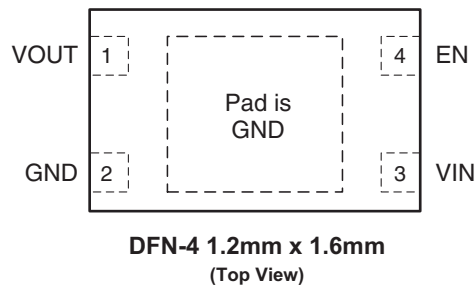
## Ordering Information

Part Number	Slew Rate	Output Discharge	Package	Environmental
AOZ1321DI-04L	800 $\mu$ s	Yes	1.2 x 1.6 DFN-4	Green Product
AOZ1321DI-01L	800 $\mu$ s	No		
AOZ1321DI-05L	1 $\mu$ s	Yes		
AOZ1321DI-02L	1 $\mu$ s	No		
AOZ1321DI-03L	100 $\mu$ s	Yes		
AOZ1321DI-06L	100 $\mu$ s	No		

- All AOS products are offered in packages with Pb-free plating and compliant to RoHS standards.
- Parts marked as Green Products (with "L" suffix) use reduced levels of Halogens, and are also RoHS compliant.

Please visit [www.aosmd.com/web/quality/rohs\\_compliant.jsp](http://www.aosmd.com/web/quality/rohs_compliant.jsp) for additional information.

## Pin Configuration



## Pin Description

Pin Name	Pin Number	Pin Function
IN	3	Input. IN is the drain of the P-channel MOSFET. It is the supply input of the IC.
GND	2	Ground.
OUT	1	Output. OUT is the source of the P-channel MOSFET.
EN	4	Enable. The P-channel MOSFET turns on when EN is logic HIGH.

## Absolute Maximum Ratings

Exceeding the Absolute Maximum ratings may damage the device.

Parameter	Rating
Input Voltage ( $V_{IN}$ )	6V
Enable Voltage ( $V_{IN}$ )	6V
Continuous Drain Current ( $I_D$ ) $T_A = 25^\circ\text{C}$ $T_A = 85^\circ\text{C}$	$\pm 2\text{A}$ $\pm 1.4\text{A}$
Pulsed Drain Current ( $I_{DP}$ )	$\pm 6\text{A}$
Continuous Diode Current ( $I_S$ )	-50mA
Storage Temperature ( $T_S$ )	-55 $^\circ\text{C}$ to +150 $^\circ\text{C}$
ESD Rating <sup>(1)</sup>	4kV

### Note:

1. Devices are inherently ESD sensitive, handling precautions are required. Human body model is a 100pF capacitor discharging through a 1.5k $\Omega$  resistor.

## Recommend Operating Ratings

The device is not guaranteed to operate beyond the Maximum Operating Ratings.

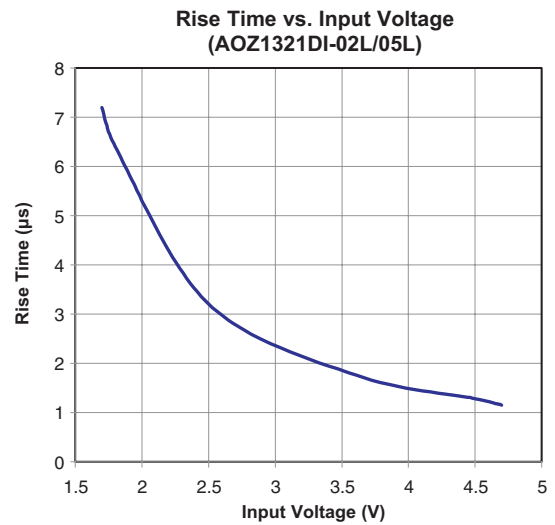
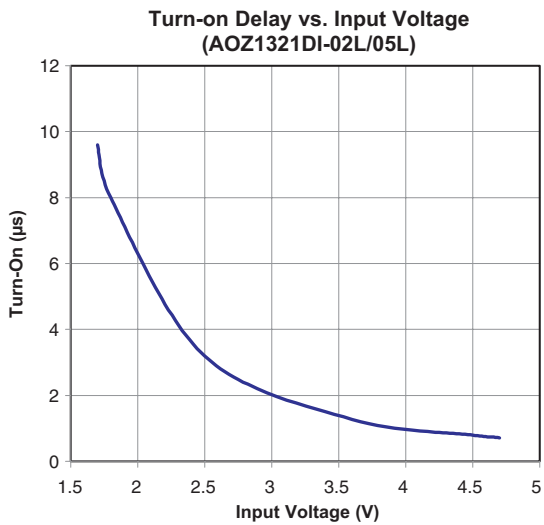
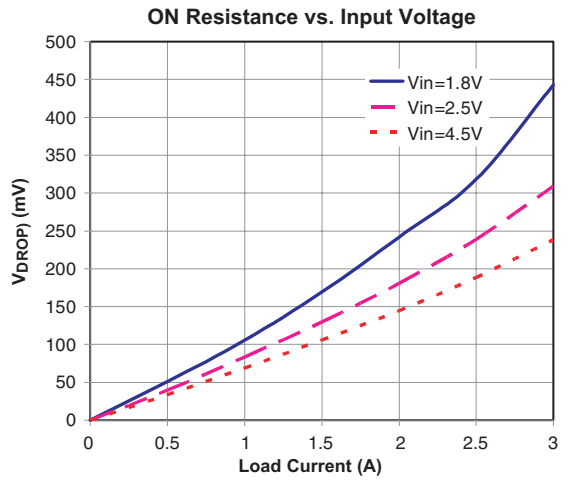
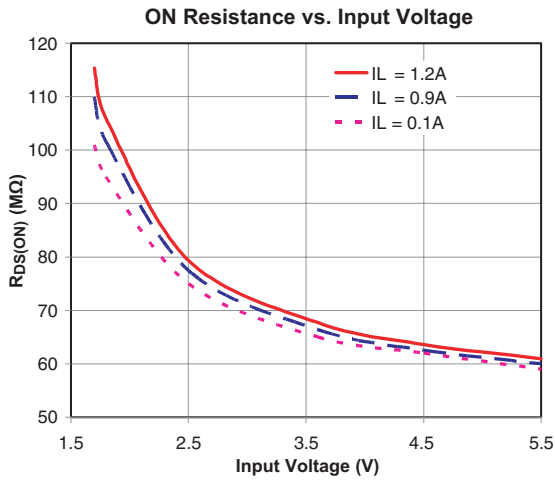
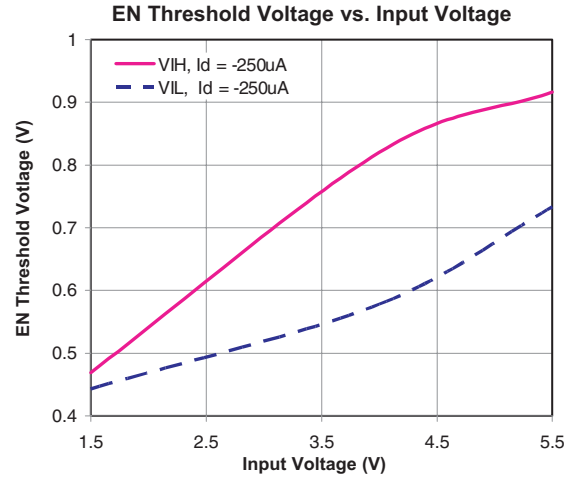
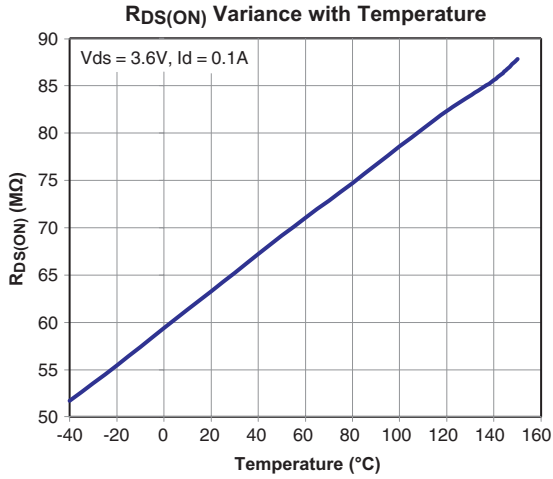
Parameter	Rating
Input Voltage ( $V_{IN}$ )	1.6V to 5.5V
Junction Temperature ( $T_J$ )	-40 $^\circ\text{C}$ to +125 $^\circ\text{C}$
Package Thermal Resistance 1.2 x 1.6 DFN-4 ( $\Theta_{JA}$ ) 1.2 x 1.6 DFN-4 ( $\Theta_{JC}$ )	143.17 $^\circ\text{C}/\text{W}$ 128.1 $^\circ\text{C}/\text{W}$

## Electrical Characteristics

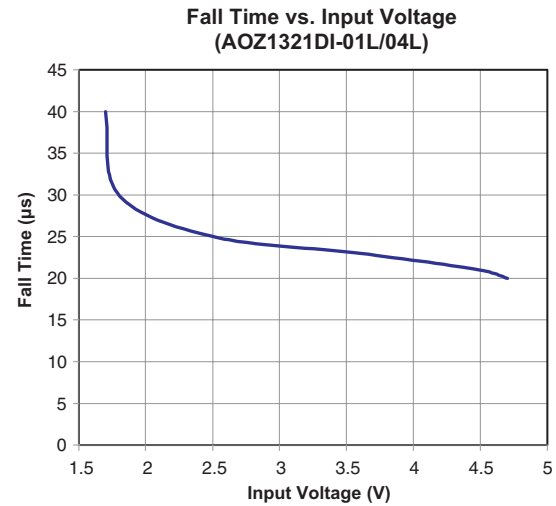
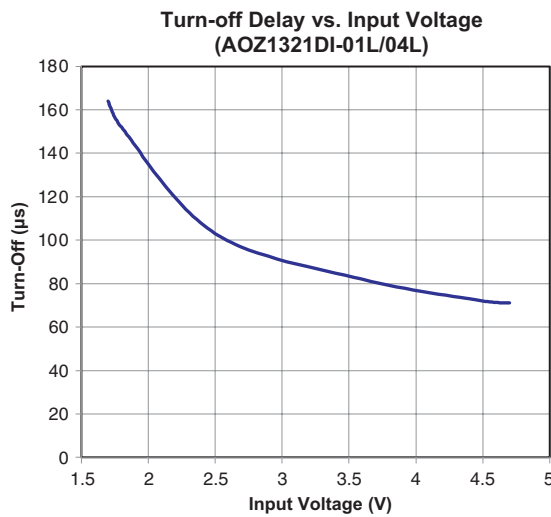
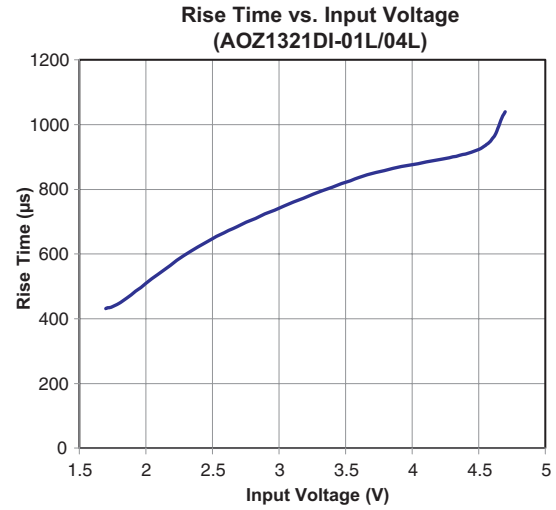
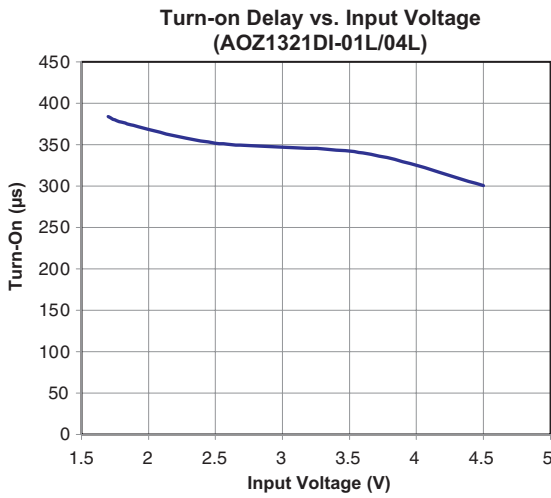
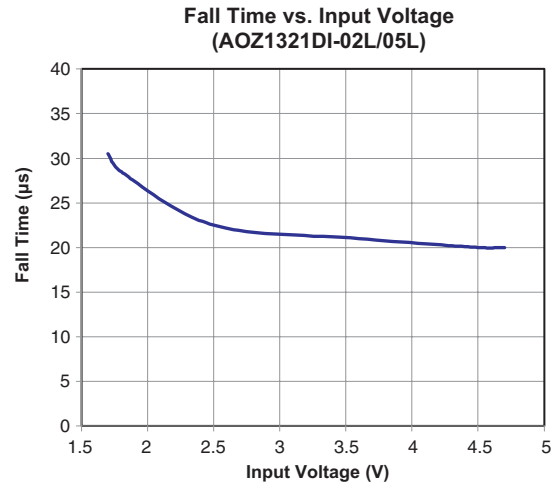
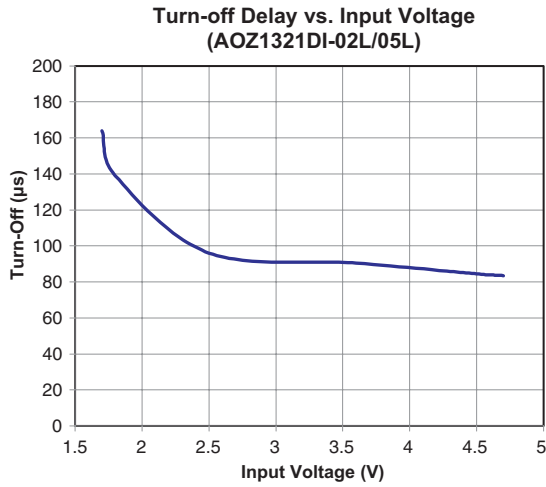
$T_A = 25^\circ\text{C}$ ,  $V_{IN} = V_{EN} = 5\text{V}$ , unless otherwise specified.

Symbol	Parameter	Conditions	Min.	Typ.	Max.	Units
$V_{EN\_TH}$	Enable Threshold Voltage	$V_{IN} = 1.6\text{V to } 4.5\text{V}$ , $I_D = -250\mu\text{A}$	0.3		1.2	V
$I_{IN}$	Quiescent Supply Current AOZ1321DI -02L/05L	$V_{IN} = V_{EN} = 5.5\text{V}$		1	3	$\mu\text{A}$
	AOZ1321DI -01L/03L/04L/06L			1.6	3	
$I_{OFF}$	OFF State Leakage Current	$V_{IN} = +5.5\text{V}$ , $V_{EN} = 0\text{V}$			1	$\mu\text{A}$
$R_{DS(ON)}$	Switch On-Resistance	$V_{IN} = 5.0\text{V}$ , $I_D = -100\text{mA}$ , $V_{EN} = 1.5\text{V}$		60	85	m $\Omega$
		$V_{IN} = 4.5\text{V}$ , $I_D = -100\text{mA}$ , $V_{EN} = 1.5\text{V}$		62	90	
		$V_{IN} = 3.6\text{V}$ , $I_D = -100\text{mA}$ , $V_{EN} = 1.5\text{V}$		65	95	
		$V_{IN} = 2.5\text{V}$ , $I_D = -100\text{mA}$ , $V_{EN} = 1.5\text{V}$		75	120	
		$V_{IN} = 1.8\text{V}$ , $I_D = -100\text{mA}$ , $V_{EN} = 1.5\text{V}$		95	180	
		$V_{IN} = 1.7\text{V}$ , $I_D = -100\text{mA}$ , $V_{EN} = 1.5\text{V}$		101	195	
		$V_{IN} = 1.6\text{V}$ , $I_D = -100\text{mA}$ , $V_{EN} = 1.5\text{V}$		114	223	
$R_{SHUTDOWN}$	Turn-Off Resistance	$V_{IN} = 3.6\text{V}$ , $I_{TEST} = 1\text{mA}$ , $V_{EN} = 0\text{V}$		162	220	$\Omega$
<b>AOZ1321DI-05L (<math>T_R = 1\mu\text{s}</math> with Output Discharge)</b>						
$T_{D(ON)}$	Output Turn-on delay	$V_{IN} = 3.6\text{V}$ , $I_D = -100\text{mA}$ , $V_{EN} = 1.5\text{V}$		1.3	2.5	$\mu\text{s}$
$T_R$	Output Rise-time		0.5	1.7	4.0	$\mu\text{s}$
$T_{D(OFF)}$	Output Turn-off delay			100	200	ns
$T_F$	Output Fall-time			20	100	ns
<b>AOZ1321DI-02L (<math>T_R = 1\mu\text{s}</math> without Output Discharge)</b>						
$T_{D(ON)}$	Output Turn-On Delay	$V_{IN} = 3.6\text{V}$ , $I_D = -100\text{mA}$ , $V_{EN} = 1.5\text{V}$		1.3	2.5	$\mu\text{s}$
$T_R$	Output Rise-time		0.5	1.7	4.0	$\mu\text{s}$
$T_{D(OFF)}$	Output Turn-Off Delay			100	200	ns
$T_F$	Output Fall-time			20	100	ns
<b>AOZ1321DI-04L (<math>T_R = 800\mu\text{s}</math> with Output Discharge)</b>						
$T_{D(ON)}$	Output Turn-On Delay	$V_{IN} = 3.6\text{V}$ , $I_D = -100\text{mA}$ , $V_{EN} = 1.5\text{V}$		320	700	$\mu\text{s}$
$T_R$	Output Rise Time		500	800	1500	$\mu\text{s}$
$T_{D(OFF)}$	Output Turn-Off Delay			60	200	ns
$T_F$	Output Fall-time			20	100	ns
<b>AOZ1321DI-01L (<math>T_R = 800\mu\text{s}</math> without Output Discharge)</b>						
$T_{D(ON)}$	Output Turn-On Delay	$V_{IN} = 3.6\text{V}$ , $I_D = -100\text{mA}$ , $V_{EN} = 1.5\text{V}$		320	700	$\mu\text{s}$
$T_R$	Output Rise Time		500	800	1500	$\mu\text{s}$
$T_{D(OFF)}$	Output Turn-Off Delay			60	200	ns
$T_F$	Output Fall-time			20	100	ns
<b>AOZ1321DI-03L (<math>T_R = 100\mu\text{s}</math> with Output Discharge)</b>						
$T_{D(ON)}$	Output Turn-On Delay	$V_{IN} = 3.6\text{V}$ , $I_D = -100\text{mA}$ , $V_{EN} = 1.5\text{V}$		120	220	$\mu\text{s}$
$T_R$	Output Rise Time		50	100	200	$\mu\text{s}$
$T_{D(OFF)}$	Output Turn-Off Delay			110	200	ns
$T_F$	Output Fall-time			20	100	ns
<b>AOZ1321DI-06L (<math>T_R = 100\mu\text{s}</math> without Output Discharge)</b>						
$T_{D(ON)}$	Output Turn-On Delay	$V_{IN} = 3.6\text{V}$ , $I_D = -100\text{mA}$ , $V_{EN} = 1.5\text{V}$		120	220	$\mu\text{s}$
$T_R$	Output Rise Time		50	100	200	$\mu\text{s}$
$T_{D(OFF)}$	Output Turn-Off Delay			110	200	ns
$T_F$	Output Fall-time			20	100	ns

## Typical Operating Characteristics

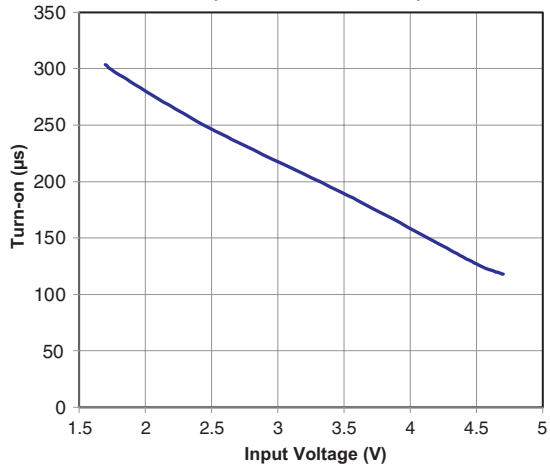


Typical Operating Characteristics (Continued)

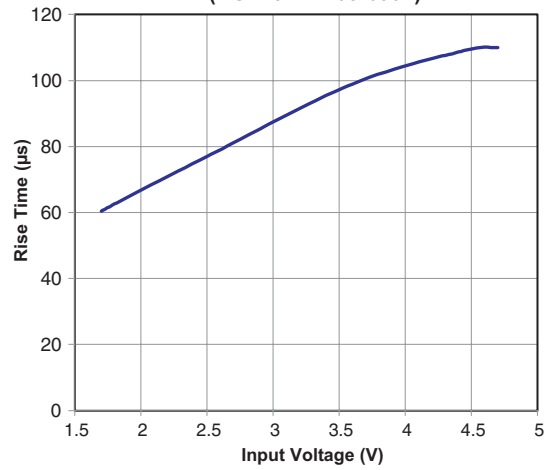


**Typical Operating Characteristics** (Continued)

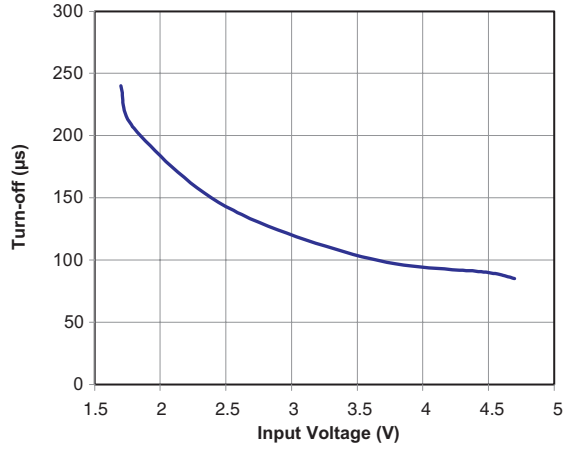
**Turn-on Delay vs. Input Voltage**  
(AOZ1321DI-03L/06L)



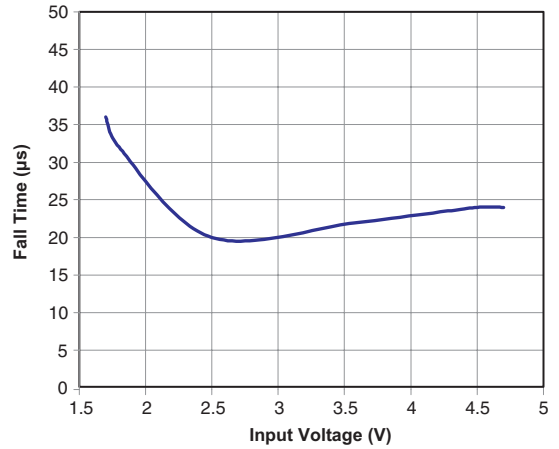
**Rise Time vs. Input Voltage**  
(AOZ1321DI-03L/06L)



**Turn-off Delay vs. Input Voltage**  
(AOZ1321DI-03L/06L)



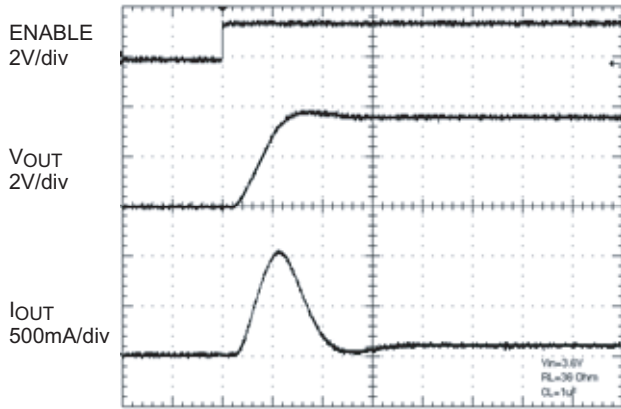
**Fall Time vs. Input Voltage**  
(AOZ1321DI-03L/06L)



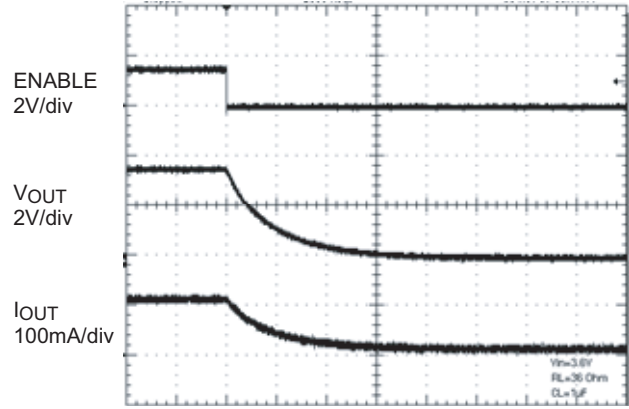
## Functional Characteristics

AOZ1321DI-02L, AOZ1321DI-05L

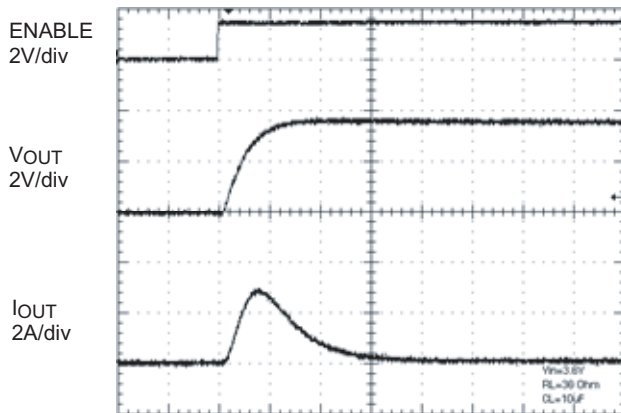
Turn-On Timing



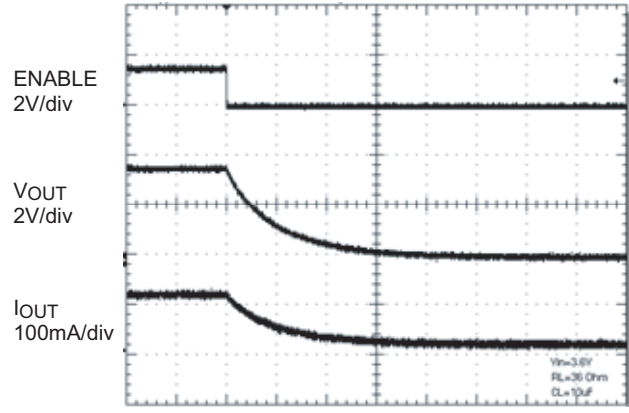
Turn-Off Timing



Turn-On Timing



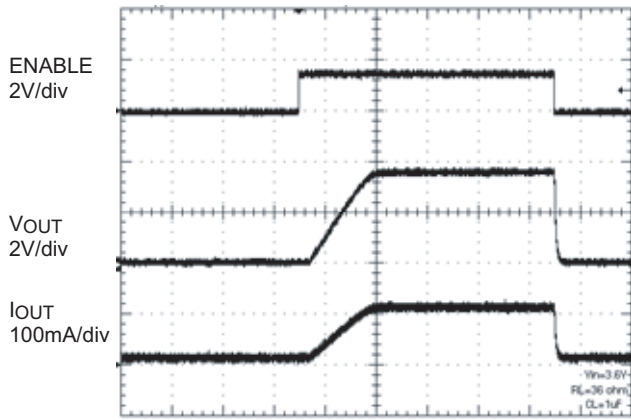
Turn-Off Timing



Functional Characteristics (Continued)

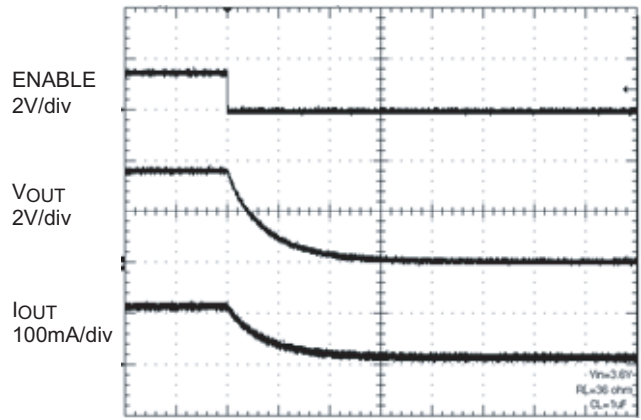
AOZ1321DI-01L, AOZ1321DI-04L

Turn-On/Turn-Off Timing



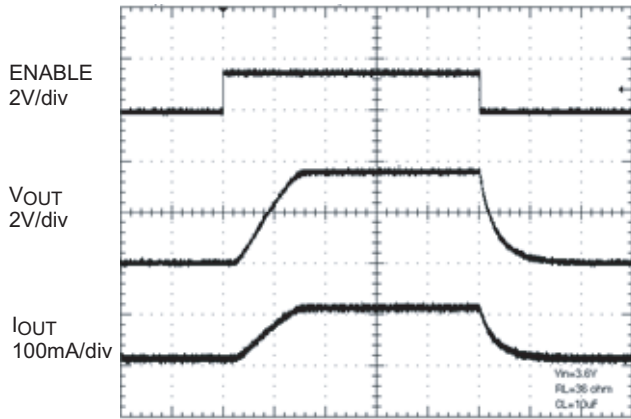
Time: 1ms/div

Turn-Off Timing



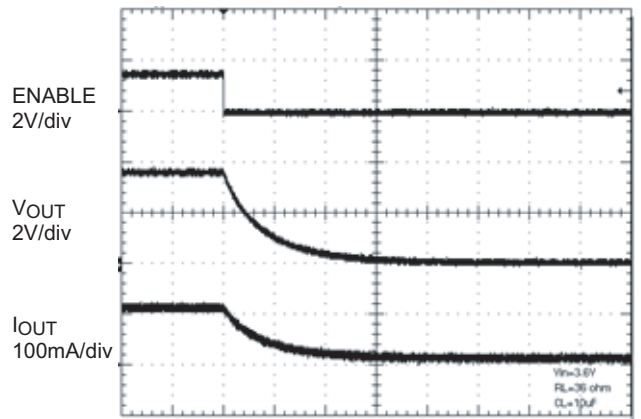
Time: 40µs/div

Turn-On/Turn-Off Timing



Time: 1ms/div

Turn-Off Timing



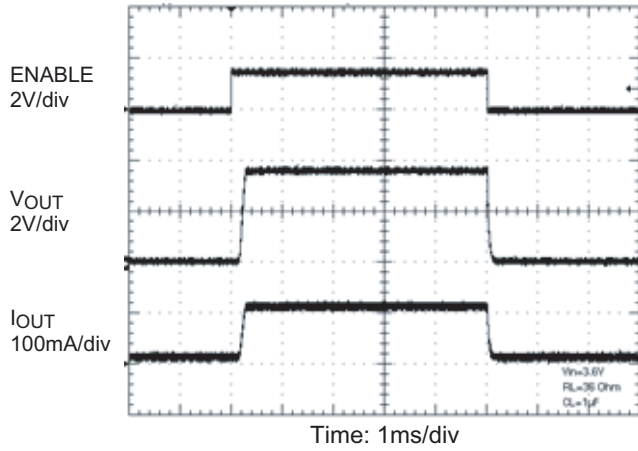
Time: 400µs/div



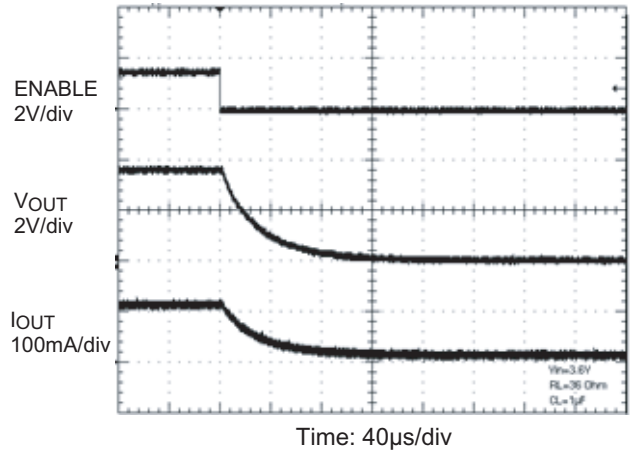
Functional Characteristics (Continued)

AOZ1321DI-03L, AOZ1321DI-06L

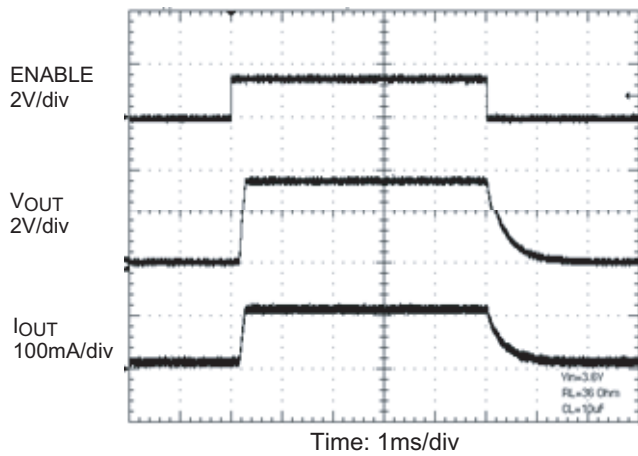
Turn-On/Turn-Off Timing



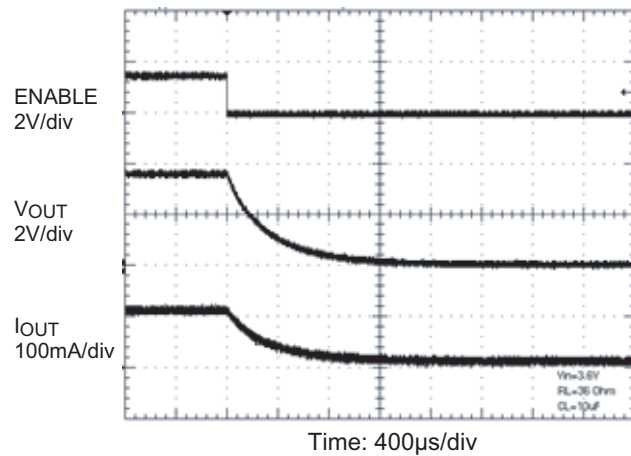
Turn-Off Timing



Turn-On/Turn-Off Timing



Turn-Off Timing



### Timing Diagram

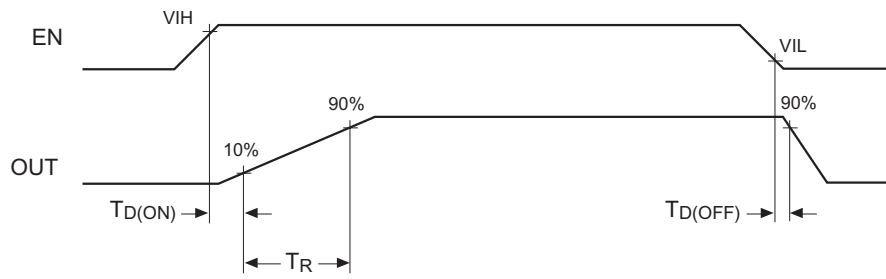


Figure 1. AOZ1321 Timing Diagram

### Functional Block Diagram

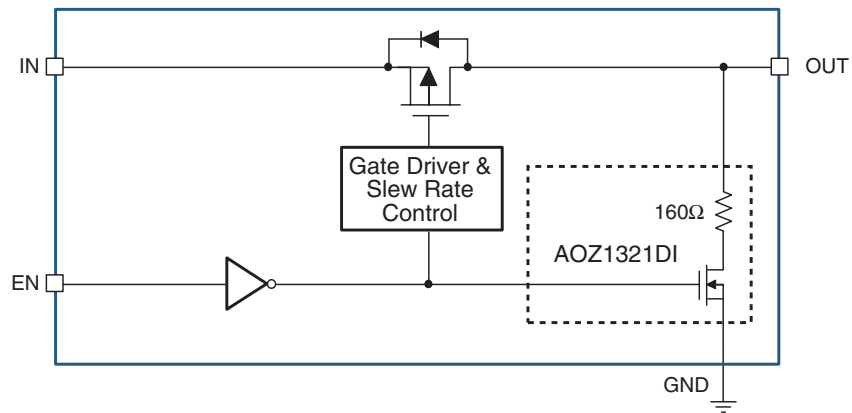


Figure 2. Functional Block Diagram

---

## Detailed Description

### Internal Discharge Resistor

The AOZ1321DI has an internal 160Ω resistor to discharge any remaining voltage from the system to the ground that is store in a capacitive load. This provides a safe shutdown of the system to prevent any damages to the devices. This function is controlled from the Enable pin.

### Slew Rate Control

The AOZ1321DI is a family of P-channel high-side load switches with controlled slew rate. The device is enabled when the EN pin is high. Once enabled, the gate driver and slew-rate control circuitry immediately raises the source-to-gate voltage of the P-channel MOSFET to its threshold level, and then gradually turns on the MOSFET by linearly increasing the source-to-gate voltage. This slow turn-on action effectively limits the input inrush current and provides a nice ramp for the output voltage. After the MOSFET is fully enhanced, the AOZ1321DI quickly increases the source-to-gate voltage to the full input voltage to minimize on resistance and reduce power dissipation.

Three slew-rate options are available. AOZ1321DI-01L and AOZ1321DI-04L have slew rate of 800us. This option significantly reduces the inrush current when the MOSFET turns on, allowing the use of very small input capacitor. AOZ1321DI-02L and -05L have no slew rate control and the MOSFET can be turned on within 1us. This option is suitable for applications that require very fast switching. AOZ1321DI-03L and -06L have moderate slew rate to 100μs. The AOZ1321DI-03L, -04L and -05L options include an internal output discharge circuit that quickly discharges the output to ground when the device is disabled.

### On/Off Control

The AOZ1321DI is enabled when the EN pin is asserted high. The device is disabled when the EN pin is asserted low. The EN input is compatible with both TTL and CMOS logic.

---

## Applications Information

### Input Capacitor Selection

Use a 1μF or larger capacitor for input bypassing. Place the capacitor close to the IN pins of AOZ1321DI.

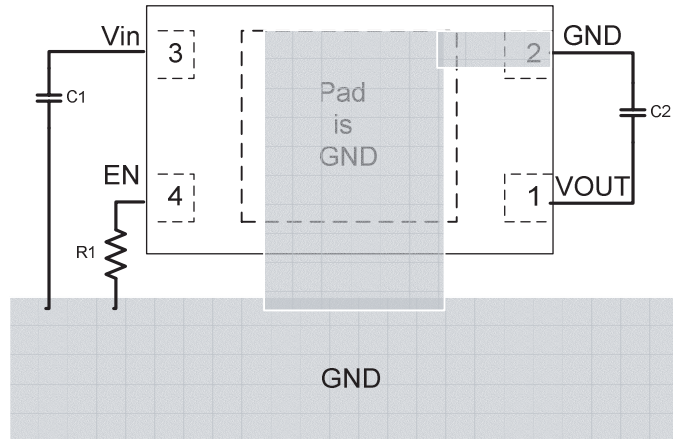
### Output Capacitor Selection

Use a 0.1μF or larger capacitor between OUT and GND. The capacitance does not affect the turn-on slew rate. However, a larger capacitor makes the initial turn-on transient smoother.

### Layout Guidelines

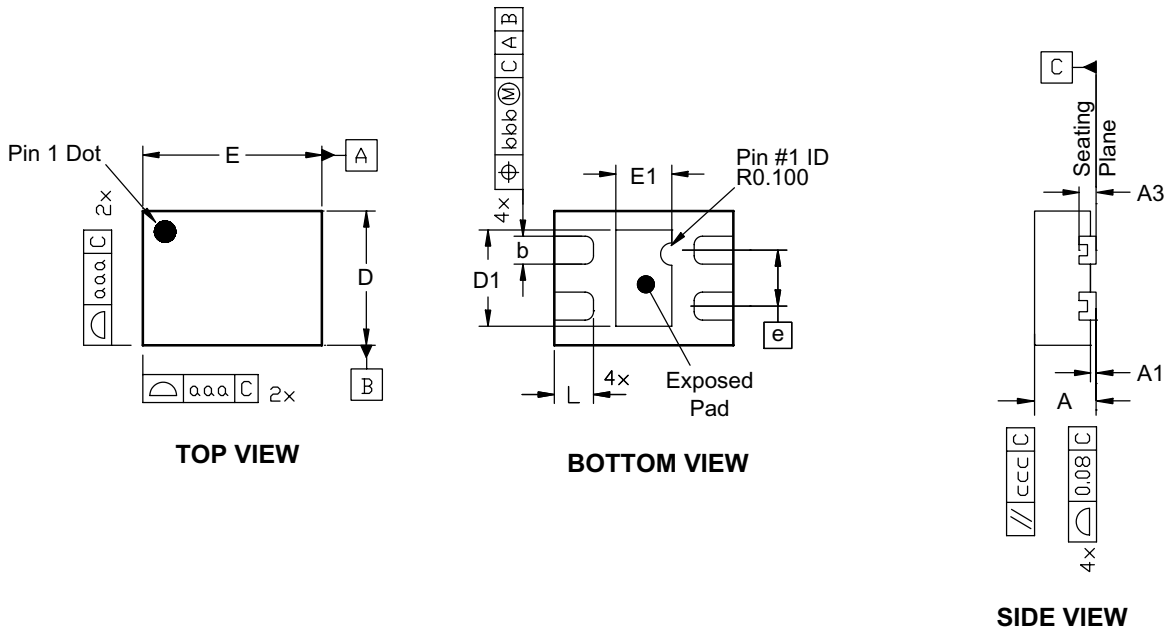
Good PCB is important for improving the thermal performance of AOZ1321DI. Place the input and output bypass capacitors close to the IN and OUT pins. The input and output PCB traces should be as wide as possible for the given PCB space. Use a ground plane to enhance the

power dissipation capability of the device. The AOZ1321DI evaluation board can be used as a layout example. The PCB layout of AOZ1321DI evaluation board is shown in Figure 3.

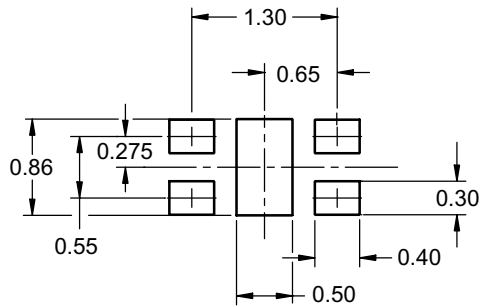


**Figure 3. AOZ1321DI PCB Layout**

Package Dimensions, DFN 1.2 x 1.6 4L



RECOMMENDED LAND PATTERN



UNIT: mm

Dimensions in millimeters

Symbols	Min.	Nom.	Max.
A	0.50	0.55	0.60
A1	0	—	0.05
A3	0.152 REF.		
b	0.20	0.25	0.30
E	1.55	1.60	1.65
E1	0.45	0.50	0.55
D	1.15	1.20	1.25
D1	0.81	0.86	0.91
e	0.5 BSC		
L	0.30	0.35	0.40
aaa	—	0.15	—
bbb	—	0.10	—
ccc	—	0.10	—

Dimensions in inches

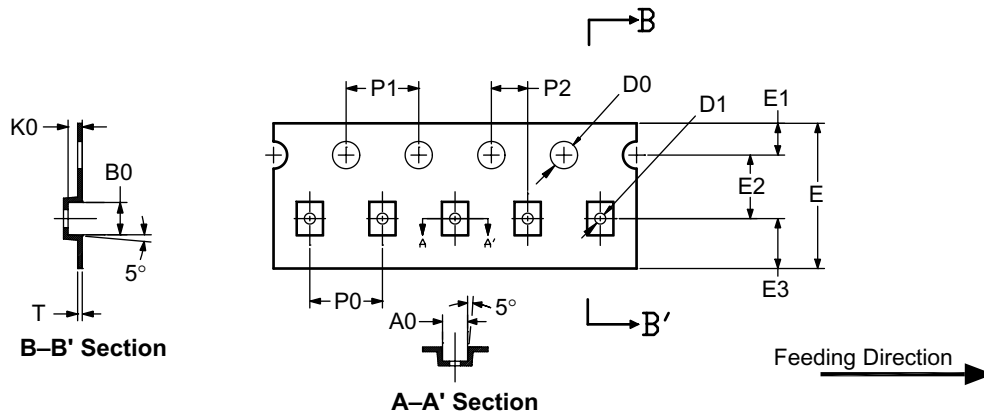
Symbols	Min.	Nom.	Max.
A	0.020	0.022	0.024
A1	0	—	0.002
A3	0.006 REF.		
b	0.008	0.010	0.012
E	0.061	0.063	0.065
E1	0.018	0.020	0.022
D	0.045	0.047	0.049
D1	0.032	0.034	0.036
e	0.020 BSC		
L	0.012	0.014	0.016
aaa	—	0.006	—
bbb	—	0.004	—
ccc	—	0.004	—

Notes:

- Controlling dimension is millimeter, converted inch dimensions are not necessarily exact.
- Coplanarity ccc applies to the terminals and all other bottom surface metallization.

## Tape and Reel Dimensions, DFN 1.2 x 1.6 4L

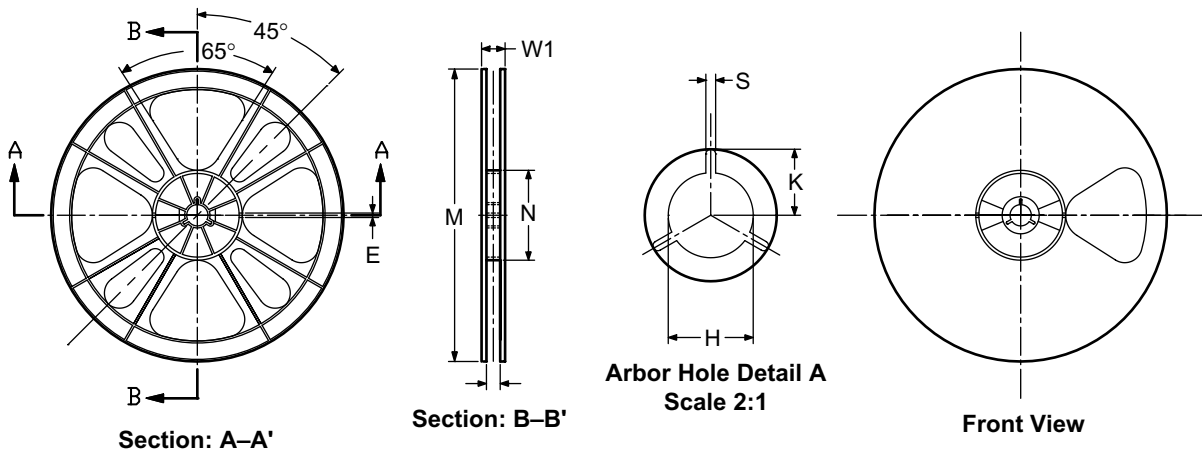
### Carrier Tape



UNIT: mm

Package	T	B0	A0	K0	D0	D1	E	E1	E2	P0	P1	P2
DFN 1.2x1.6	0.254 ±0.02	1.78 ±0.05	1.38 ±0.05	0.78 ±0.05	∅1.5 ±0.10	∅0.6 ±0.05	8.00 +0.30/-0.10	1.75 ±0.10	3.50 ±0.05	4.00 ±0.10	4.00 ±0.10	2.00 ±0.05

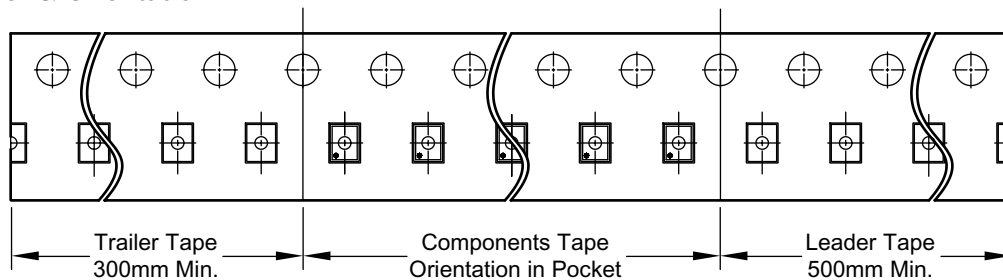
### Reel



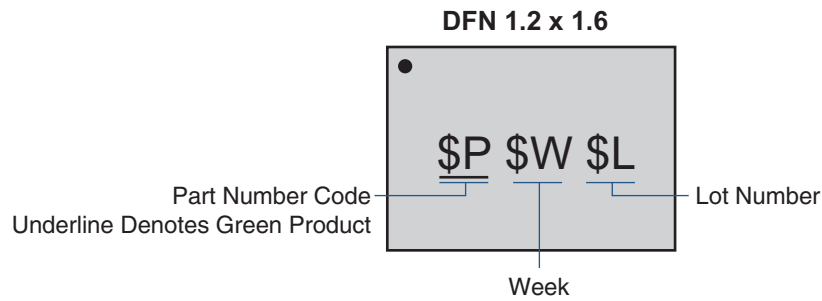
UNIT: mm

Tape Size	Reel Size	M	N	W	W1	H	S	K	E
8mm	∅149	∅179.0 ±0.50	∅55.0 ±0.5	8.4 +1.5/-0.0	14.4 Max.	∅13.0 +0.5/-0.2	1.5 Min.	10.1 Min.	2.70 ±0.2

### Leader / Trailer & Orientation



## Package Marking



**Alpha & Omega Semiconductor reserves the right to make changes at any time without notice.**

### LIFE SUPPORT POLICY

ALPHA & OMEGA SEMICONDUCTOR PRODUCTS ARE NOT AUTHORIZED FOR USE AS CRITICAL COMPONENTS IN LIFE SUPPORT DEVICES OR SYSTEMS.

As used herein:

- |   |   |
|---|---|
| <p>1. Life support devices or systems are devices or systems which, (a) are intended for surgical implant into the body or (b) support or sustain life, and (c) whose failure to perform when properly used in accordance with instructions for use provided in the labeling, can be reasonably expected to result in a significant injury of the user.</p> | <p>2. A critical component in any component of a life support, device, or system whose failure to perform can be reasonably expected to cause the failure of the life support device or system, or to affect its safety or effectiveness.</p> |
|---|---|