



Technical Data Sheet

Chip LED with Bi-Color(Multi-Color)

19-22/S2T1D-A30/2T

Features

- Package in 8mm tape on 7" diameter reel.
- Compatible with automatic placement equipment.
- Compatible with infrared and vapor phase reflow solder process.
- Multi-color type.
- Pb-free.
- The product itself will remain within RoHS compliant version.

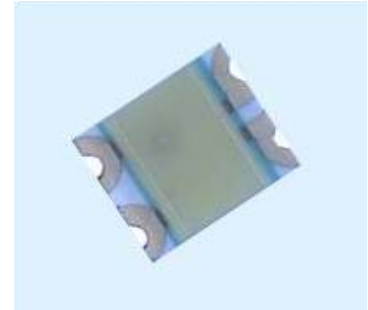

Descriptions

- The 19-22 SMD Taping is much smaller than lead frame type components, thus enable smaller board size, higher packing density, reduced storage space and finally smaller equipment to be obtained.
- Besides, lightweight makes them ideal for miniature applications. etc.

Applications

- Backlighting in dashboard and switch.
- Telecommunication: indicator and backlighting in telephone and fax.
- Flat backlight for LCD, switch and symbol.
- General use.
- Indoor signboard use.

Device Selection Guide

Chip			Lens Color
Type	Material	Emitted Color	
S2	AlGaInP	Brilliant Orange	Yellow Diffused
T1	InGaN	Pure White	

Package Outline Dimensions

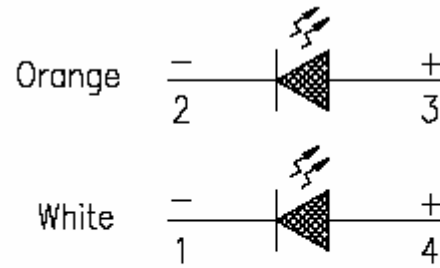
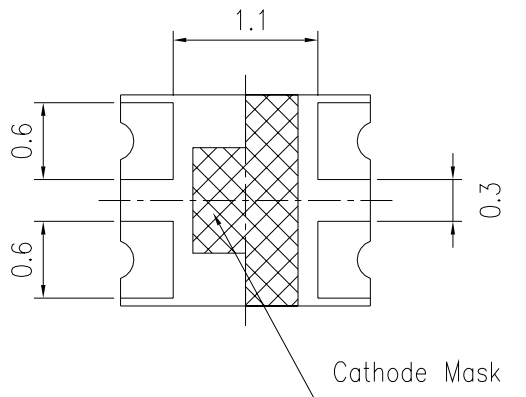
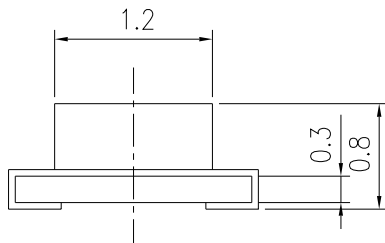
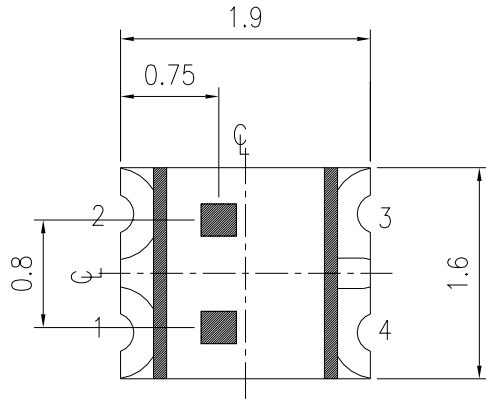

Polarity

For reflow soldering

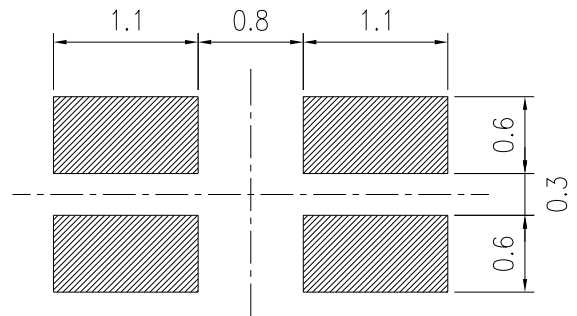

Note: The tolerances unless mentioned is $\pm 0.1\text{mm}$, Unit = mm

**Absolute Maximum Ratings (Ta=25°C)**

Parameter	Symbol	Rating	Unit
Reverse Voltage	V _R	5	V
Forward Current	I _F	S2:25 T1:25	mA
Peak Forward Current (Duty 1/10 @1KHz)	I _{FP}	S2:60 T1:100	mA
Power Dissipation	P _d	S2:60 T1:110	mW
Electrostatic Discharge(HBM)	ESD	S2:2000 T1:150	V
Operating Temperature	Topr	-40 ~ +85	°C
Storage Temperature	Tstg	-40~ +90	°C
Soldering Temperature	Tsol	Reflow Soldering : 260 °C for 10 sec. Hand Soldering : 350 °C for 3 sec.	

Electro-Optical Characteristics (Ta=25°C)

Parameter	Symbol	Min.	Typ.	Max.	Unit	Condition
Luminous Intensity	I _v S2	72.0	----	180	mcd	I _F =20mA
	T1	90.0	----	225		
Viewing Angle	2θ 1/2	-----	130	-----	deg	
Peak Wavelength	λ _p S2	----	611	-----	nm	
Dominant Wavelength	λ _d S2	-----	605	-----	nm	
Spectrum Radiation Bandwidth	Δλ S2	-----	17	-----	nm	
Forward Voltage	V _F S2	1.7	2.0	2.4	V	
	T1	2.7	3.3	3.7		
Reverse Current	I _R S2	-----	-----	10	μA	V _R =5V
	T1	-----	-----	50		

Notes:
1.Tolerance of Luminous Intensity ±10%

Bin Range Of Luminous Intensity**S2****Bin Range Of Luminous Intensity**

Bin	Min	Max	Unit	Condition
Q	72.0	112	mcd	I _F =20mA
R	112	180		

T1**Bin Range Of Luminous Intensity**

Bin	Min	Max	Unit	Condition
1	90.0	140	mcd	I _F =20mA
2	140	225		

Notes:

- 1.Tolerance of Luminous Intensity $\pm 10\%$

Typical Electro-Optical Characteristics Curves

S2

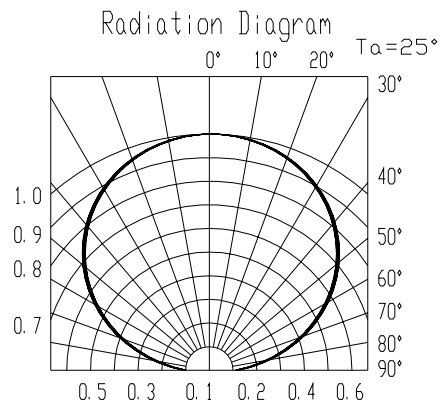
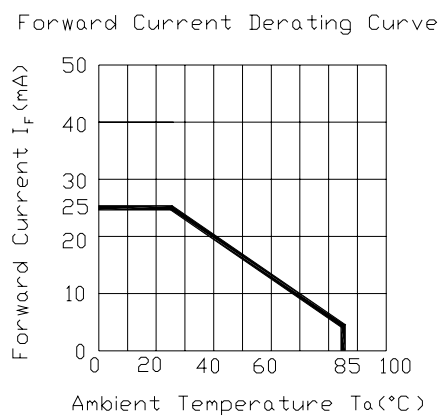
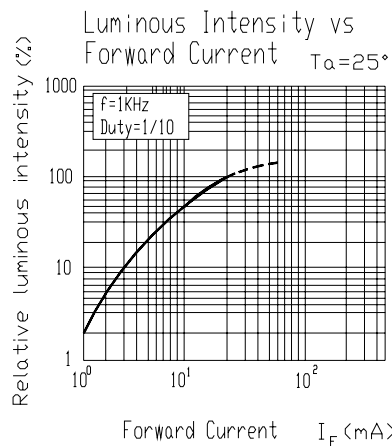
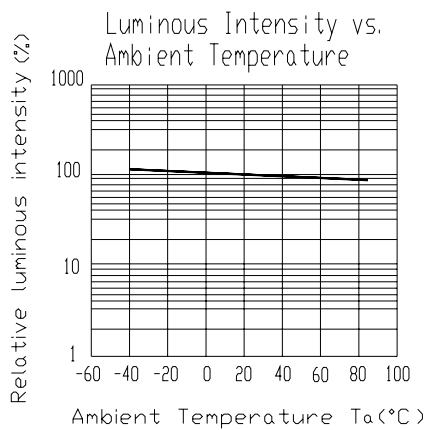
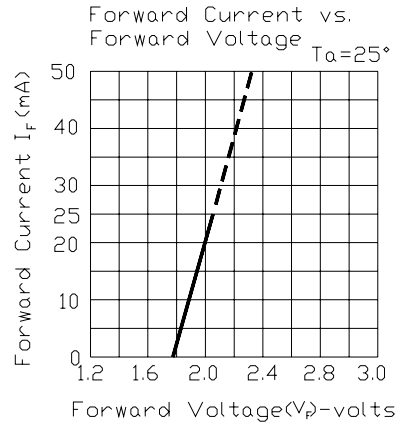
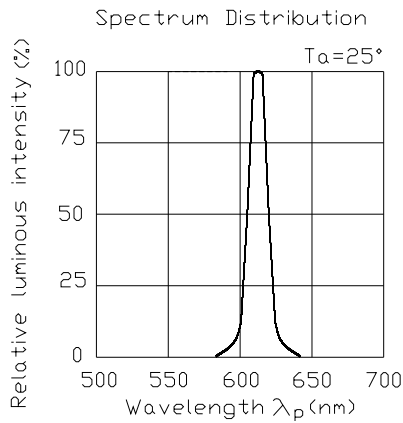

Typical Electro-Optical Characteristics Curves

T1

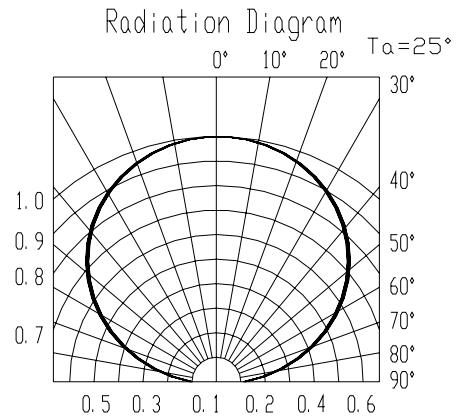
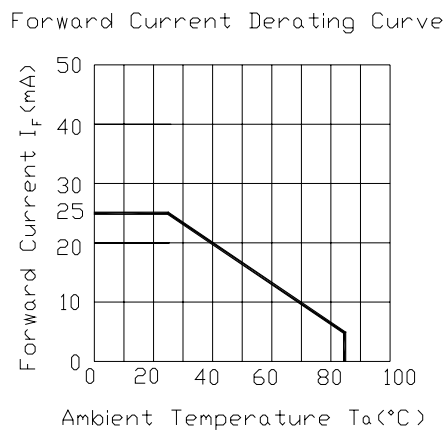
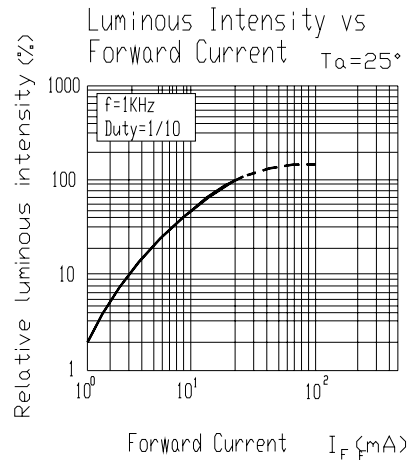
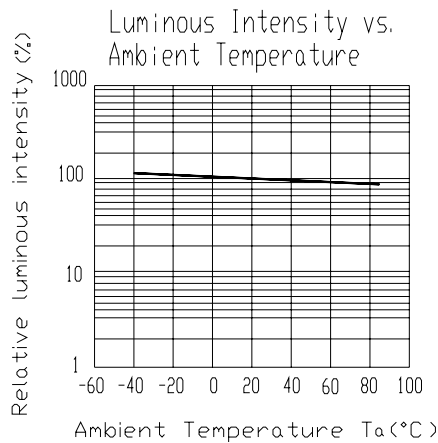
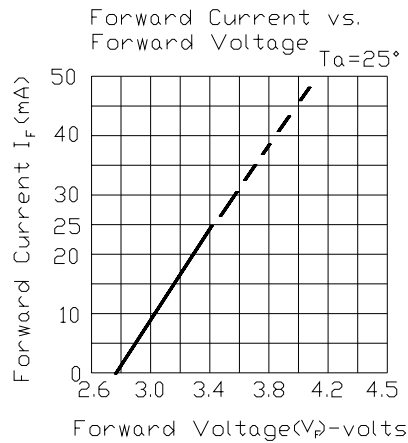
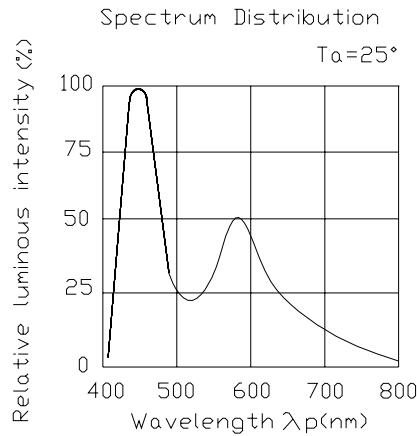

Chromaticity Coordinates Specifications for Bin Grading

Groups	Bin Code	CIE_x	CIE_y	Condition
A	1	0.274	0.226	I _F =20mA
		0.274	0.258	
		0.294	0.286	
		0.294	0.254	
	2	0.274	0.258	
		0.274	0.291	
		0.294	0.319	
		0.294	0.286	
	3	0.294	0.254	
		0.294	0.286	
		0.314	0.315	
		0.314	0.282	
	4	0.294	0.286	
		0.294	0.319	
		0.314	0.347	
		0.314	0.315	
	5	0.314	0.282	
		0.314	0.315	
		0.334	0.343	
		0.334	0.311	
	6	0.314	0.315	
		0.314	0.347	
		0.334	0.376	
		0.334	0.343	

Notes:

- 1.The C.I.E. 1931 chromaticity diagram (Tolerance ± 0.01).**
- 2.The products are sensitive to static electricity and care must be fully taken when handling products.**

Label explanation

CAT: Luminous Intensity Rank

HUE: Dom. Wavelength Rank

REF: Forward Voltage Rank

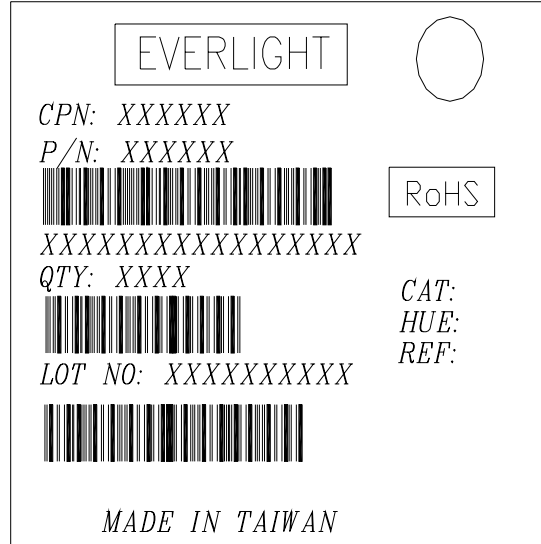

Reel Dimensions

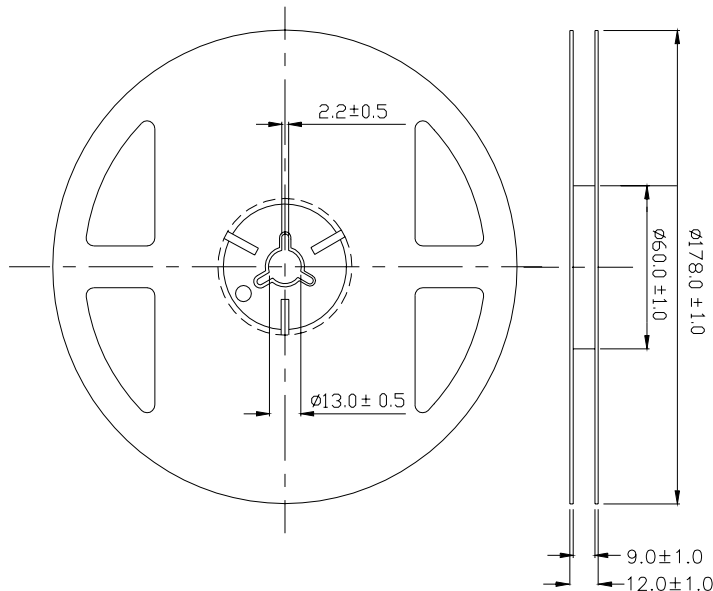

Note: The tolerances unless mentioned is $\pm 0.1\text{mm}$, Unit = mm

Carrier Tape Dimensions: Loaded quantity 2000 PCS per reel

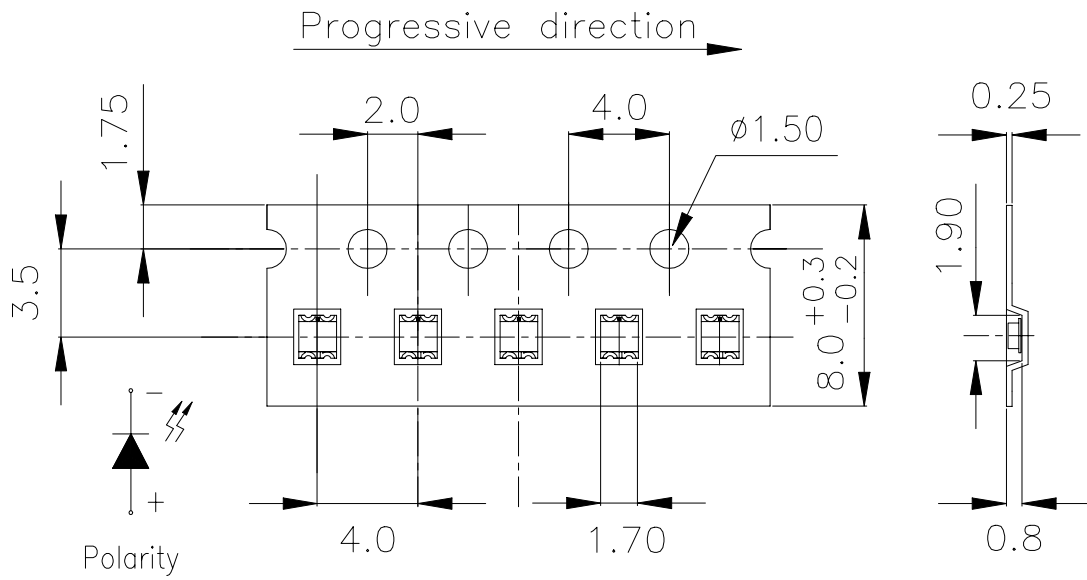

Note: The tolerances unless mentioned is $\pm 0.1\text{mm}$, Unit = mm

Moisture Resistant Packaging

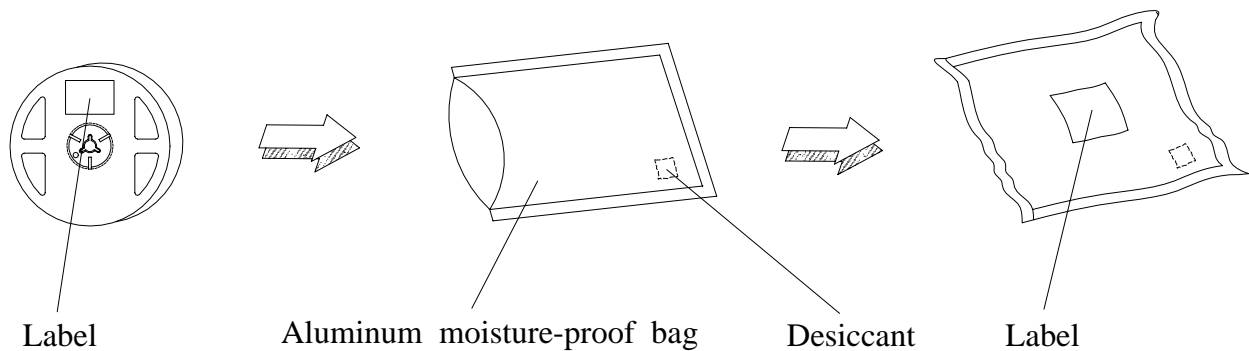

Reliability Test Items And Conditions

The reliability of products shall be satisfied with items listed below.

Confidence level : 90%

LTPD : 10%

No.	Items	Test Condition	Test Hours/Cycles	Sample Size	Ac/Re
1	Reflow Soldering	Temp. : 260°C ±5°C Min. 5sec.	6 Min.	22 PCS.	0/1
2	Temperature Cycle	H : +100°C 15min ∫ 5 min L : -40°C 15min	300 Cycles	22 PCS.	0/1
3	Thermal Shock	H : +100°C 5min ∫ 10 sec L : -10°C 5min	300 Cycles	22 PCS.	0/1
4	High Temperature Storage	Temp. : 100°C	1000 Hrs.	22 PCS.	0/1
5	Low Temperature Storage	Temp. : -40°C	1000 Hrs.	22 PCS.	0/1
6	DC Operating Life	I _F = 20 mA	1000 Hrs.	22 PCS.	0/1
7	High Temperature / High Humidity	85°C / 85%RH	1000 Hrs.	22 PCS.	0/1

Precautions For Use

1. Over-current-proof

Customer must apply resistors for protection, otherwise slight voltage shift will cause big current change (Burn out will happen).

2. Storage

2.1 Do not open moisture proof bag before the products are ready to use.

2.2 Before opening the package: The LEDs should be kept at 30°C or less and 90%RH or less.

2.3 After opening the package: The LED's floor life is 1 year under 30°C or less and 60% RH or less.

If unused LEDs remain, it should be stored in moisture proof packages.

2.4 If the moisture absorbent material (silica gel) has faded away or the LEDs have exceeded the storage time, baking treatment should be performed using the following conditions.

Baking treatment : 60±5°C for 24 hours.

3. Soldering Condition

3.1 Pb-free solder temperature profile

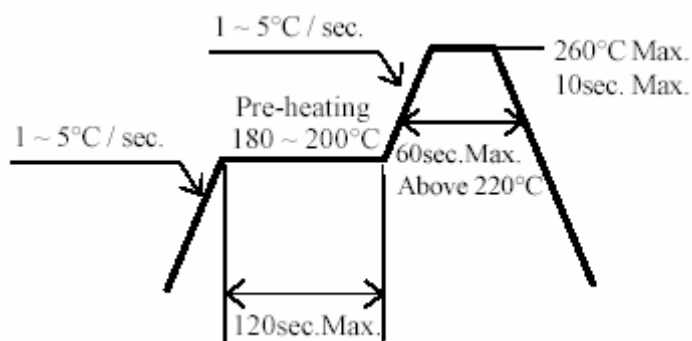

3.2 Reflow soldering should not be done more than two times.

3.3 When soldering, do not put stress on the LEDs during heating.

3.4 After soldering, do not warp the circuit board.

4.Soldering Iron

Each terminal is to go to the tip of soldering iron temperature less than 350°C for 3 seconds within once in less than the soldering iron capacity 25W. Leave two seconds and more intervals, and do soldering of each terminal. Be careful because the damage of the product is often started at the time of the hand solder.

5.Repairing

Repair should not be done after the LEDs have been soldered. When repairing is unavoidable, a double-head soldering iron should be used (as below figure). It should be confirmed beforehand whether the characteristics of the LEDs will or will not be damaged by repairing.

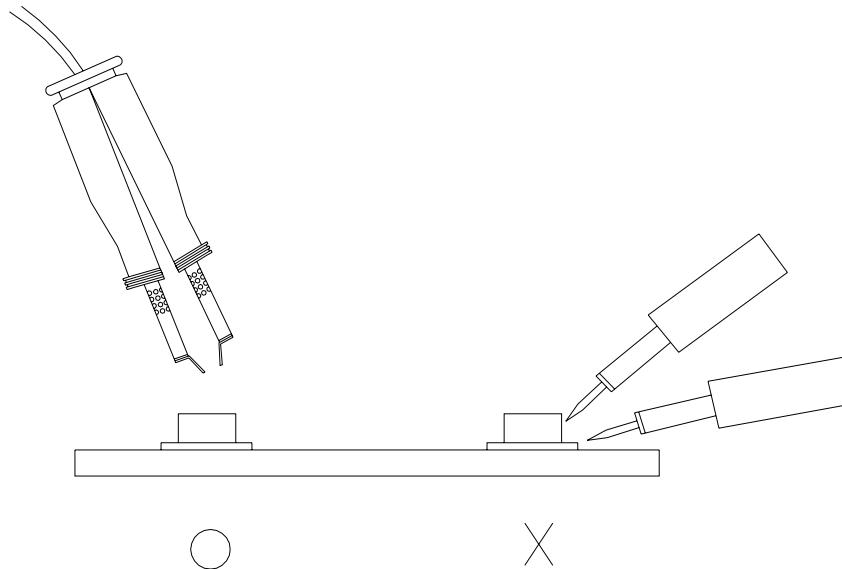

EVERLIGHT ELECTRONICS CO., LTD.

Office: No 25, Lane 76, Sec 3, Chung Yang Rd,
Tucheng, Taipei 236, Taiwan, R.O.C

Tel: 886-2-2267-2000, 2267-9936

Fax: 886-2267-6244, 2267-6189, 2267-6306

<http://www.everlight.com>