

SMD ■ Side View LEDs

99-218GUN2C/L6575G6J7U37/TR8-T



Features

- . Side view white LED
- . White SMT package
- . Lead frame package with individual 2 pins
- . Wide viewing angle
- . Soldering methods: IR reflow soldering
- . Pb-free
- . The product itself will remain within RoHS compliant version.
- . Compliance with EU REACH.
- . Compliance Halogen Free .(Br <900 ppm ,Cl <900 ppm , Br+Cl < 1500 ppm).

Descriptions

- . Due to the package design, 99-218G has wide viewing angle, low power consumption and white LEDs are devices that are materialized by combing blue chips and special phosphor. This feature makes the LED ideal for light guide application.

Applications

- . LCD Back Light
- . Mobile Phones
- . Indicators
- . Illuminations
- . Switch Light

Coding:

99-218GUN2C /LXX XX XX X/TR8-T

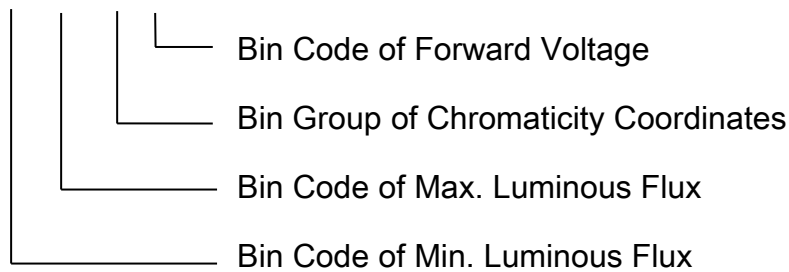

Device Selection Guide

Chip Materials	Emitted Color	Resin Color
InGaN	Pure White	Water Clear

Absolute Maximum Ratings (Ta=25°C)

Parameter	Symbol	Rating	Unit
Reverse Voltage	V_R	5	V
Forward Current	I_F	30	mA
Peak Forward Current (Duty 1/10 @10ms)	I_{FP}	60	mA
Power Dissipation	P_d	110	mW
Operating Temperature	T_{opr}	-40 ~ +85	°C
Storage Temperature	T_{stg}	-40 ~ +90	°C
Soldering Temperature	T_{sol}	Reflow Soldering : 260 °C for 10 sec. Hand Soldering : 350 °C for 3 sec.	

Notes: *1The products are sensitive to static electricity and must be carefully taken when handling products.

Electro-Optical Characteristics (Ta=25°C)

Parameter	Symbol	Min.	Typ.	Max.	Unit	Condition
Luminous Flux	Φ	6.50	-----	7.75	lm	
Viewing Angle	2θ 1/2	-----	120	-----	deg	IF=20mA
Forward Voltage	V_F	2.80	-----	3.30	V	
Reverse Current	IR	-----	-----	1	μ A	$V_R=5V$

Notes:

1. Tolerance of Luminous Flux: $\pm 5\%$
2. Tolerance of Forward Voltage: $\pm 0.05V$

Bin Range of Luminous Flux

Bin Code	Lm(Min.)	Lm(Max.)	Unit	Condition	Mcd(Min.)	Mcd(Max.)
L65	6.50	6.75			2325	2415
L67	6.75	7.00			2415	2505
L70	7.00	7.25	lm	I _F =20mA	2505	2595
L72	7.25	7.50			2595	2685
L75	7.50	7.75			2685	2775

Notes: Tolerance of Luminous Intensity, Luminous Flux: $\pm 5\%$

The spec. for intensity is quantified in lm, mcd is for reference only.

Bin Range of Forward Voltage

Bin Code	Min.	Max.	Unit	Condition
U3	2.80	2.90		
U4	2.90	3.00		
U5	3.00	3.10	V	I _F =20mA
U6	3.10	3.20		
U7	3.20	3.30		

Note: Tolerance of Forward Voltage: $\pm 0.05V$

Chromaticity Coordinates of Bin Code

Bin Code	CIE_x	CIE_y	Bin Code	CIE_x	CIE_y
G6	0.2650	0.2190	H6	0.2700	0.2282
	0.2650	0.2290		0.2700	0.2382
	0.2700	0.2382		0.2750	0.2474
	0.2700	0.2282		0.2750	0.2374
G7	0.2650	0.2090	H7	0.2700	0.2182
	0.2650	0.2190		0.2700	0.2282
	0.2700	0.2282		0.2750	0.2374
	0.2700	0.2182		0.2750	0.2274
I6	0.2750	0.2374	J6	0.2800	0.2466
	0.2750	0.2474		0.2800	0.2566
	0.2800	0.2566		0.2850	0.2658
	0.2800	0.2466		0.2850	0.2558
I7	0.2750	0.2274	J7	0.2800	0.2366
	0.2750	0.2374		0.2800	0.2466
	0.2800	0.2466		0.2850	0.2558
	0.2800	0.2366		0.2850	0.2458

Note: Tolerance of Chromaticity Coordinates: ± 0.005

The C.I.E. 1931 Chromaticity Diagram

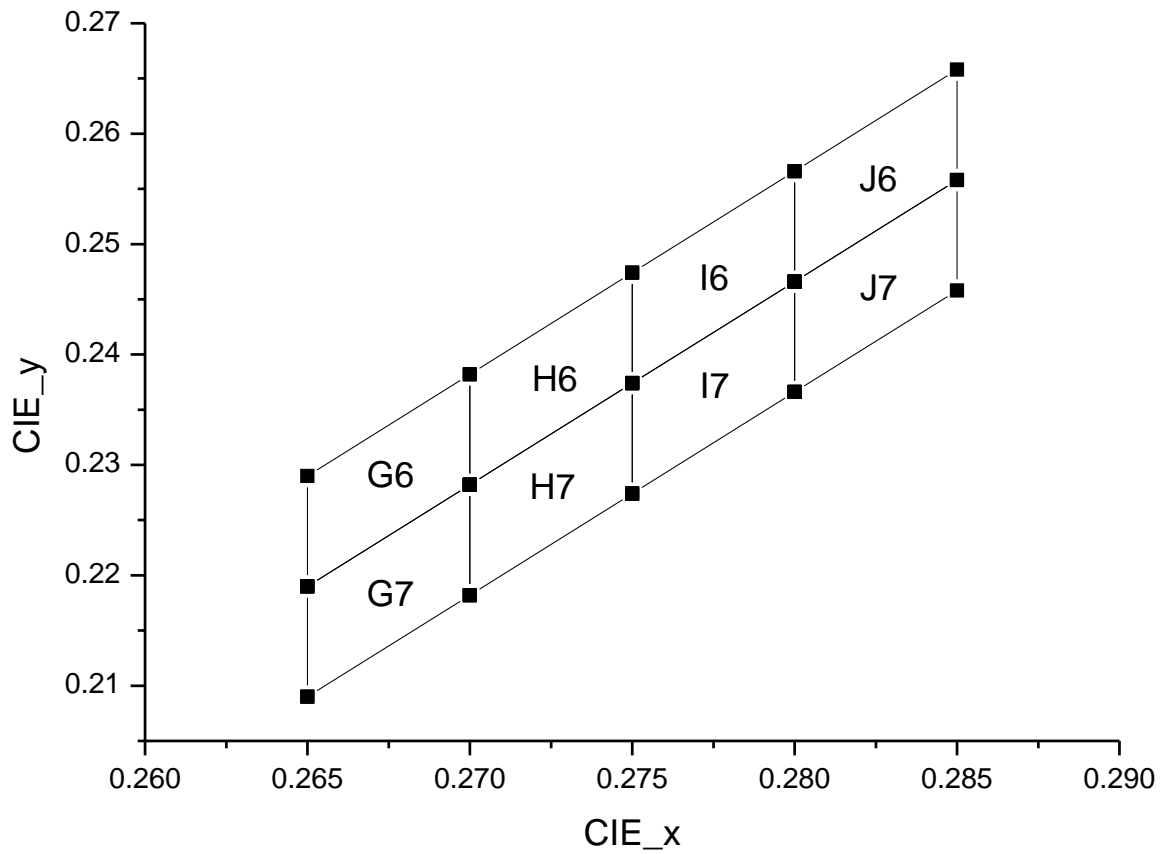

Package Outline Dimensions

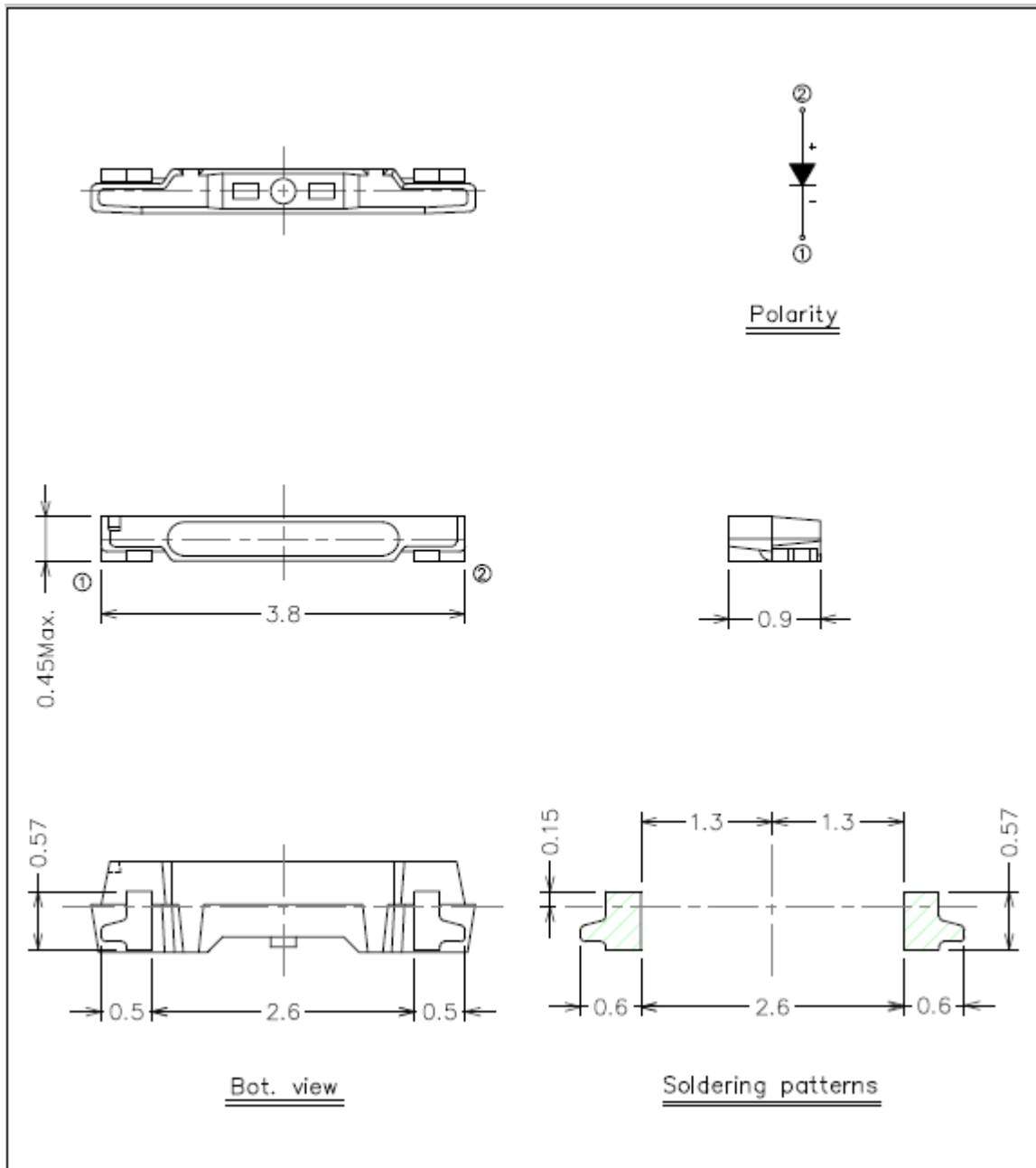

Note: The tolerances unless dimensions are ± 0.1 mm.

Typical Electro-Optical-Thermal Characteristics Curves

1. Spectrum Distribution Current

($T_A=25^\circ\text{C}$, $I_F=20\text{mA}$)

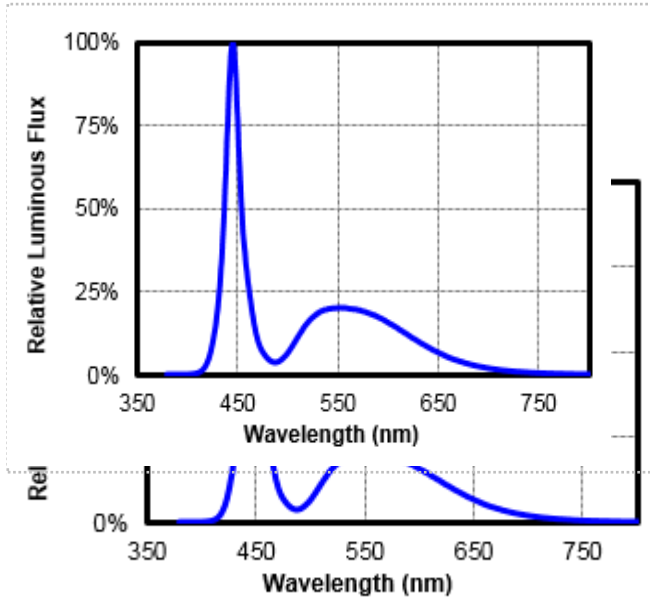

2. Relative Luminous Intensity vs. Forward

($T_A=25^\circ\text{C}$)

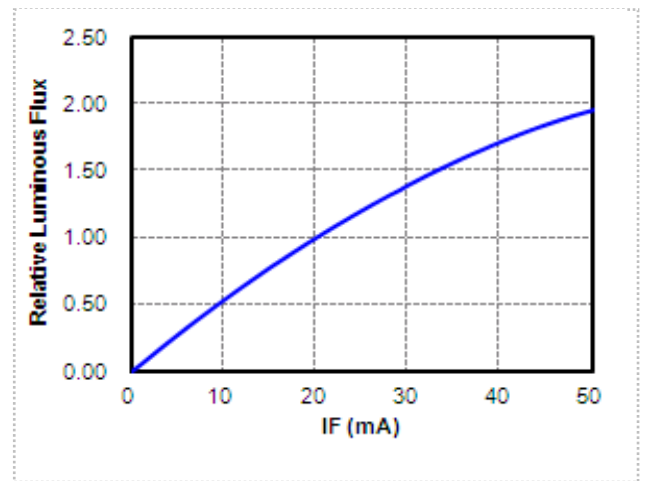

4. Radiation Diagram

($T_A=25^\circ\text{C}$, $I_F=20\text{mA}$)

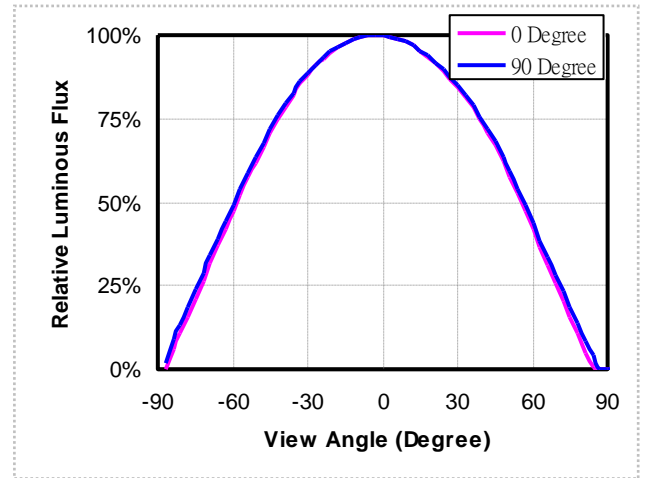
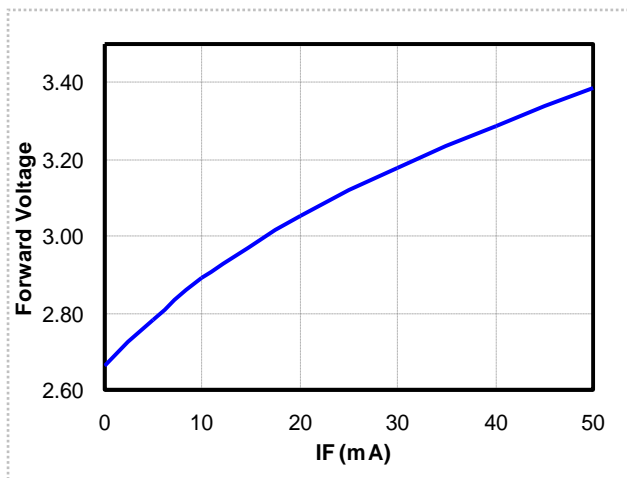

Typical Electro-Optical-Thermal Characteristics Curves

5. Relative Luminous Flux vs. Ambient Temperature
 (IF=20mA)

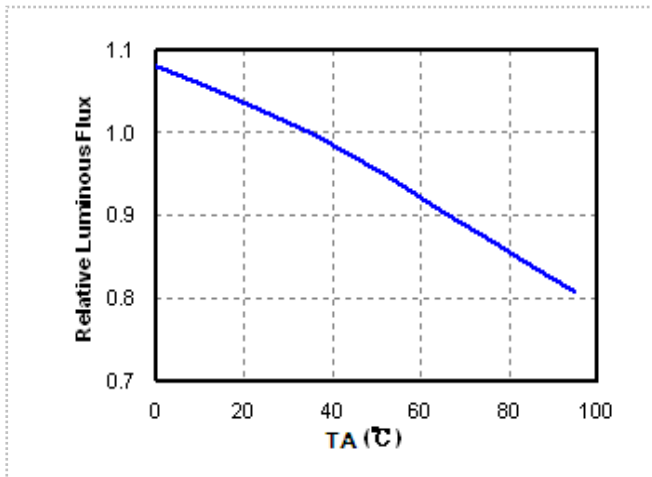

6. Forward Voltage vs. Ambient Temperature
 (IF=20mA)

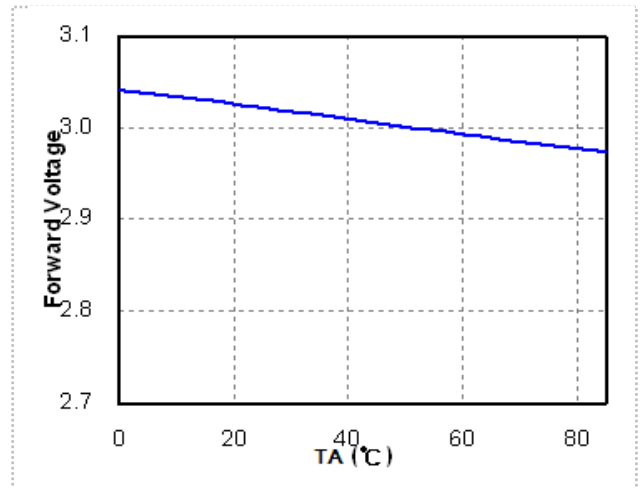

7. Chromaticity Coordinates vs. Ambient Temperature
 (IF=20mA)

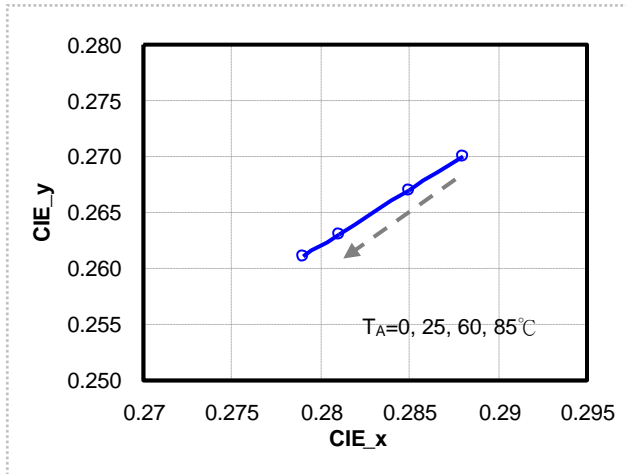

8. Forward Current De-rating Curve

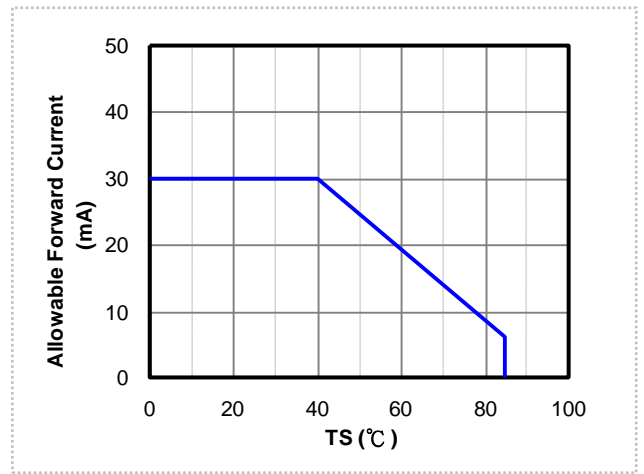

Label Explanation

- CPN: Customer's Product Number
- P/N: Product Number
- QTY: Packing Quantity
- CAT: Luminous Intensity Rank
- HUE: C.I.E Range Code Of Group
- REF: Forward Voltage Rank
- LOT No: Lot Number



Reel Dimensions

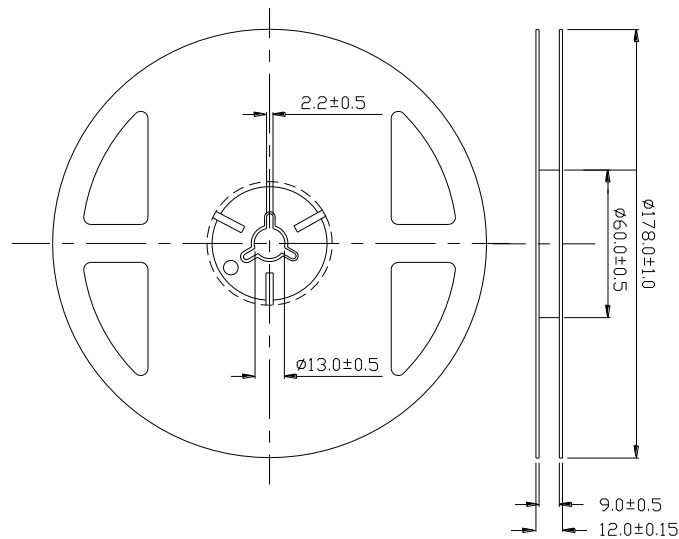

Note: The tolerances unless dimension are ± 0.1 mm.

Carrier Tape Dimensions:

Loaded Quantity 250 up/500/1000/2000 pcs. Per Reel

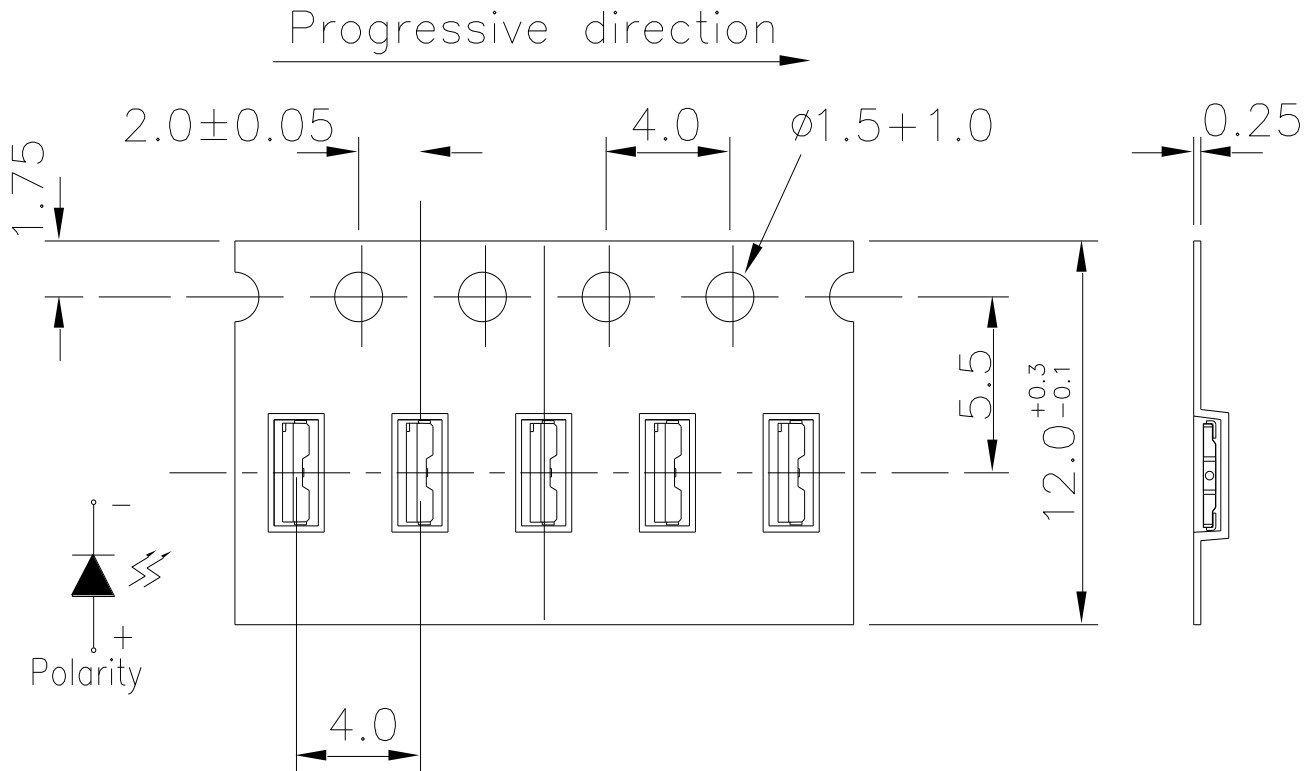

Note: The tolerances unless mentioned is ± 0.1 mm, Unit = mm.

Moisture Resistant Packaging

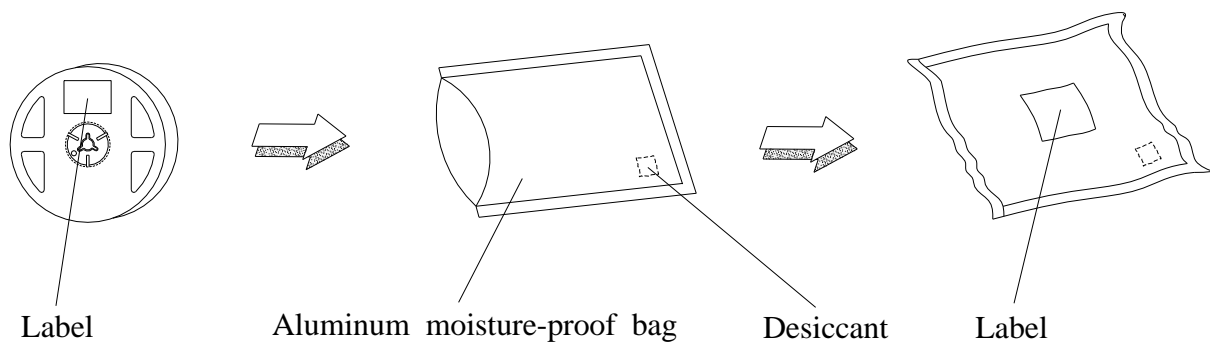

Note: Actual photo of standard packing bag

Reliability Test Items and Conditions

The reliability of products shall be satisfied with items listed below.

Confidence level : 90%

LTPD : 10%

NO	Item	Test Condition		Test Hours / Times	Criteria	
		Temp./ Humidity	I _F (mA)		I _v @ 20mA	V _F @ 20mA
1	Reflow Soldering	T _{Sld} = 260°C, Max. 10sec.		2 times	<±10%	<±10%
2	Temperature cycle	-40°C 30min.	~ (5min.)	100°C 30min.	200 cycles	
3	Thermal Shock	-10°C 20min.	~ (<15sec.)	100°C 20min.	200 cycles	
4	Low Temp. Storage	T _a = -40°C	--	1000 hrs		
5	High Temp. Storage	T _a = 100°C	--	1000 hrs		
6	Temp. Humidity Storage	T _a = 60°C/ 90%RH	--	1000 hrs		
7	Steady State Operating Life of Low Temp.	T _a = -40°C	20	1000 hrs		I _v > 70%, V _F < 110%,
8	Steady State Operating Life Condition 1	T _a = 25°C/ Room Humidity	20	1000 hrs		
9	Steady State Operating Life Condition 2	T _a = 60°C	20	1000 hrs		
10	Steady State Operating Life of High Temp.	T _a = 85°C	5	1000 hrs		
11	Steady State Operating Life of High Humidity Heat	T _a = 60°C/ 90%RH	20	1000 hrs		

Notes:

1. Sampling for each test item: 22 (pcs.)
2. Measurements are performed after allowing the LEDs to return to room temperature.

Precautions for Use

1. Over-current-proof

Customer must apply resistors for protection, otherwise slight voltage shift will cause big current change (Burn out will happen).

2. Storage

2.1 Do not open moisture proof bag before the products are ready to use.

2.2 Before opening the package: The LEDs should be used within one year and kept at 30°C or less and 70%RH or less.

2.3 After opening the package: We recommend that the LED should be soldered quickly (within 3 days). The soldering condition is 30°C or less and 60%RH or less. If unused LEDs remain, it should be stored in moisture proof packages.

2.4 If the moisture absorbent material (silica gel) has faded away or the LEDs have exceeded the storage time, baking treatment should be performed using the following conditions. Baking treatment: 60±5°C for 24 hours. (One time only)

3. Soldering Condition

3.1 Pb-free solder temperature profile

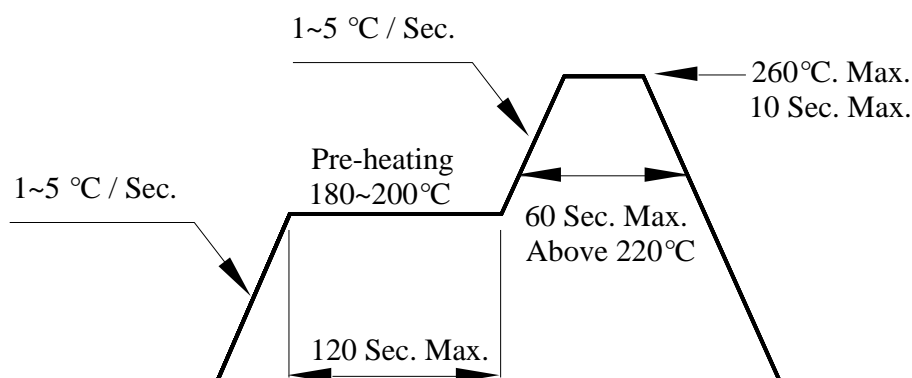

3.2 Reflow soldering should not be done more than two times.

3.3 When soldering, do not put stress on the LEDs during heating.

3.4 After soldering, do not warp the circuit board.

4. Soldering Iron

Each terminal is to go to the tip of soldering iron temperature less than 350°C for 3 seconds within once in less than the soldering iron capacity 25W. Leave two seconds and more intervals, and do soldering of each terminal. Be careful because the damage of the product is often started at the time of the hand solder.

5. Repairing

Repair should not be done after the LEDs have been soldered. When repairing is unavoidable, a double-head soldering iron should be used (as below figure). It should be confirmed beforehand whether the characteristics of the LEDs will or will not be damaged by repairing.

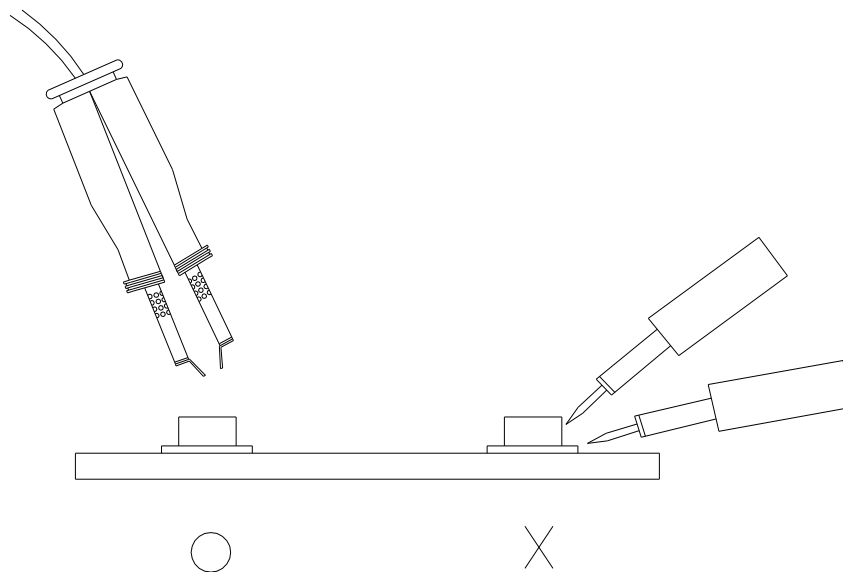

6. Handling Indications

During processing, mechanical stress on the surface should be minimized as much as possible. Sharp objects of all types should not be used to pierce the sealing compound.