

# MDS Medical AC-DC Open Frame

## 24Volt, 400Watt / MDS-400AUS24 B

# 400AUS24 B



### Highlights & Features

- Safety Approvals to IEC 60601-1 3.1rd ed. & IEC 60950-1
- Compliant with IEC 60601-1-2 4th Ed. Requirements
- Low touch current (<0.1mA Normal & ,0.3mA single fault)
- Over-Voltage/Load/Temperature & Short Circuit protections
- 2 Million Hours MTBF
- 2 x MOPP (means of patient protection)
- 3 years warranty

### Safety Standards



CB Certified for worldwide use

**Model Number:** MDS-400AUS24 B  
**Unit Weight:** 910 grams (32.1 ounces)  
**Dimensions (W x L x H):** 97x198x41.5 mm

## General Description

The MDS series of embedded power supply come with universal AC input at 90Vac to 264Vac. Other features include low earth leakage, risk management report available and the electric shock protection comply with 2 x MOPP. The MDS series is certified for EMC standards according to EN 55011 for industrial, scientific and medical (ISM) radio-frequency equipment and EN 55022 for Information Technology Equipment (ITE) radio-frequency equipment. In addition, only recognized Japanese capacitors are used.

The MDS series of embedded power supply come with both medical and ITE safety approvals including UL/cUL/CCC/CE and CB certification and are fully compliant with RoHS Directive 2011/65/EU for environmental protection.

## Model Information

### Medical AC-DC Open Frame

Model Number	Input Voltage Range	Output Voltage	Conversion Current Output	Forced Air Current Output
MDS-400AUS24 B	90-264Vac	24Vdc	12.5A	16.67A*

\*16.67A with 200LFM force air

## Model Numbering

<b>MDS</b> <small>Delta Medical power Supply</small>	-	<b>400</b> <small>Max wattage in the product series. Maybe lower at some voltage. 400 → 400W</small>	<b>AUS</b> <small>Family Code</small>	<b>24</b> <small>Output Voltage Single Output: 24 for 24V</small>	<b>B</b>
---	---	---	--	--	----------

# MDS Medical AC-DC Open Frame

## 24Volt, 400Watt / MDS-400AUS24 B

### Specifications

#### Input Ratings / Characteristics

Nominal Input Voltage	100-240Vac
Input Voltage Range	90-264Vac
Nominal Input Frequency	50-60Hz
Input Frequency Range	47-63Hz
Input Current (max)	5.5A @ 90Vac, 2.7A @ 264Vac
Efficiency (typ.)	91.94%, Reference Fig.1
Standby Power (max)	1.2W
Inrush Current (typ.)	60A @ 115Vac, 60A @ 230Vac
Earth Leakage Current (max)	0.1mA @ 240Vac NC <sup>1)</sup> , 0.3mA @ 264Vac SFC <sup>2)</sup>

1) NC: normal condition

2) SFC: single fault condition

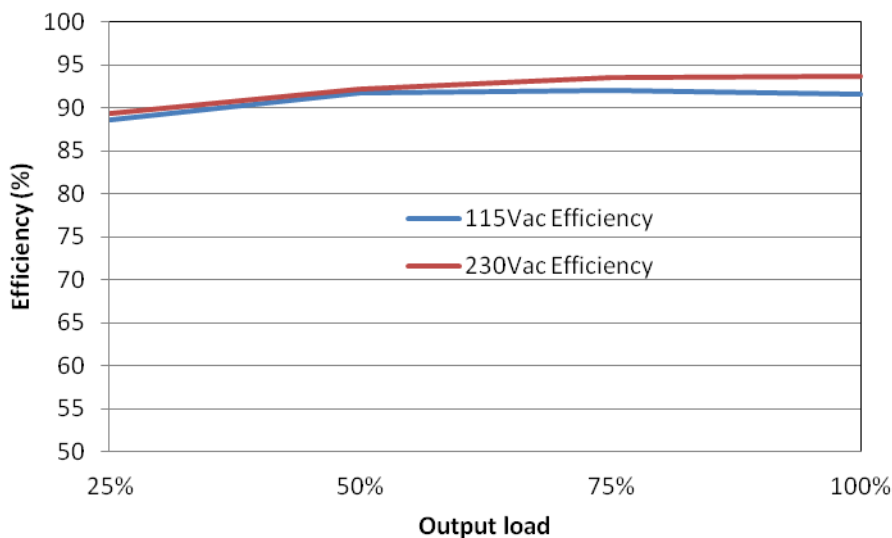

Fig.1 Efficiency versus output load

#### Output Ratings / Characteristics

Nominal Output Voltage	24Vdc
Output Voltage Tolerance	± 2%
Output Current	16.67A with 200LFM force air, 12.5A for convection
Output Power	400W with 200LFM force air, 300W for convection
Line Regulation (max)	±0.5%
Fan Supply	12V 0.25A
Remote Sense	Compensates for up to 500mV voltage drop
Ripple & Noise (typ.)	123.2mV pk-pk @ Full load, Reference Fig. 2,
Hold-up Time (min)	12ms @ 115Vac



# MDS Medical AC-DC Open Frame

## 24Volt, 400Watt / MDS-400AUS24 B

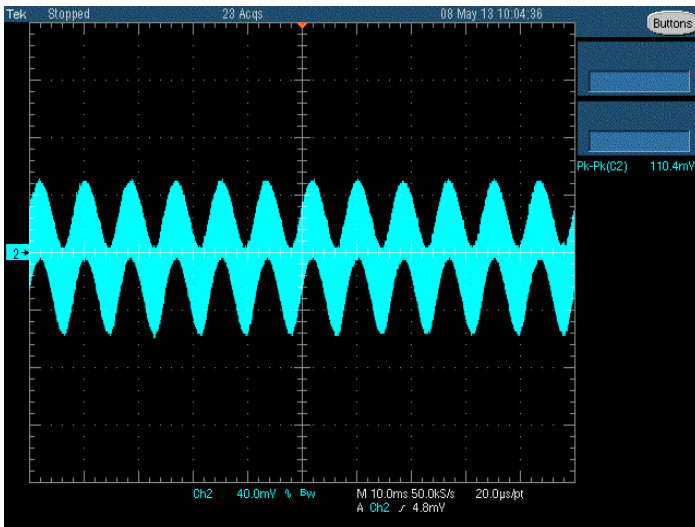

(a) 115V

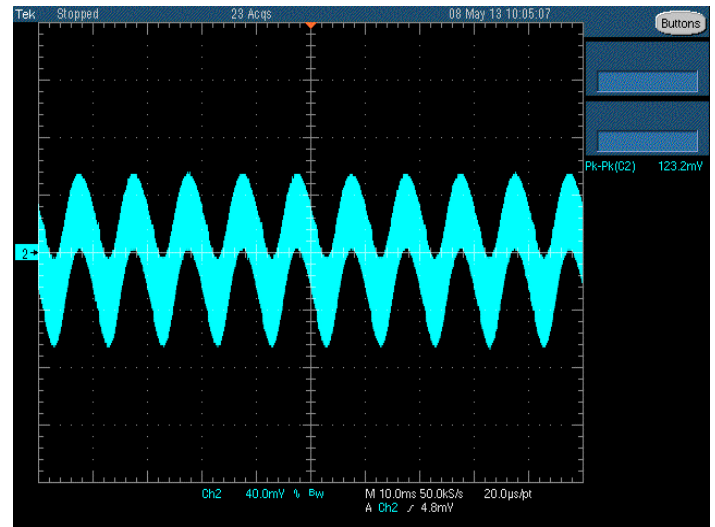

(b) 230V

Fig. 2 Ripple & Noise example, 20MHz BW

### Ripple & Noise measurement circuit

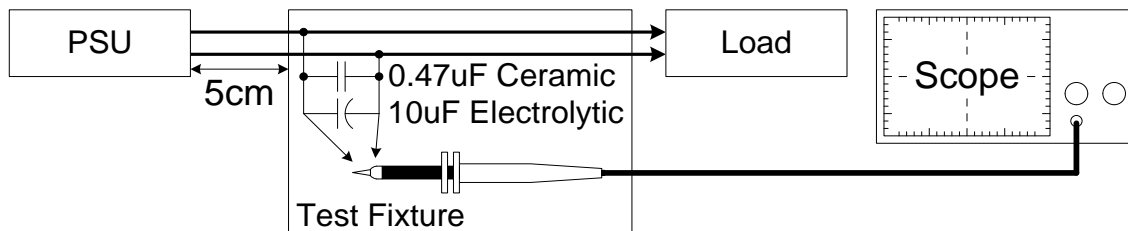

## Mechanical

Case Chassis	AL1100F(+Electrocoat)	
Case Cover	NA	
Dimensions (W x Lx H)	97.0x198.0x41.5 mm	
Unit Weight	910 grams (32.1 ounces)	
Power de-rating curve	See Fig. 3 (400W with forced air flow)	
Terminal	Input	DECA: T33-BM1103A301
	Output	DECA: T33-BM1104A301
DC Fan	Output	JWT: A2508WV0-2P

## Environment

Surrounding Air Temperature	Operating	-10°C to +70°C
	Storage	-40°C to +85°C
Power De-rating		-10°C to +50°C 100% load 50°C to 70°C with load de-rate power
Operating Humidity		10-95% RH (Non-Condensing)
Operating Altitude		3,000 meters (9,842 feet or 70kPa)
Shock Test (Non-Operating)		50G, 11ms, 3 shocks for each direction
Vibration (Operating)		5-500Hz, 2.09Grms, 20 minute for each three axis

# MDS Medical AC-DC Open Frame

## 24Volt, 400Watt / MDS-400AUS24 B

### Protections

Overvoltage (max)	150%, Latch Mode
Over load / Over current (max)	130% of rated load current, Hiccup Mode, (Non-Latching, Auto-Recovery)
Over Temperature	Latch Mode,
Short Circuit	Hiccup Mode, (Non-Latching, Auto-Recovery)
Protection Against Shock	Class I with PE* connection

\*PE: Protective Earth

### Reliability Data

MTBF	2 Million Hrs based on Telecordia SR-332
------	--

### Safety Standards / Directives

Electrical Safety	IEC60601-1 3 <sup>rd</sup> and 3.1 <sup>rd</sup> edition CB report IEC60601-1 edition 3.1rd (2012), EN60601-1 (2006) + A11 + A1 + A12, CAN/CSA-C22.2 NO. 60601-1:14, ANSI/AAMI ES60601-1:2005/(R)2012	
ITE	IEC60950-1 (Ed.2,2005), GB4943.1-2011, GB9254-2008, GB17625.1-2003	
CE	MDD Directive 93/42/EEC	
Material and Parts	RoHS Directive 2011/65/EU Compliant	
Galvanic Isolation	Input to Output	4000 Vac
	Input to Ground	1500 Vac
	Output to Ground	500 Vac

# MDS Medical AC-DC Open Frame

## 24Volt, 400Watt / MDS-400AUS24 B

### EMC (Compliant with IEC 60601-1-2 4th Ed. Requirements)

EMC / Emissions		EN55011/EN55022,FCC Title 47:Class B
Harmonic Current Emissions	IEC61000-3-2	Meet Class D limit
Immunity to		
Voltage Flicker	IEC61000-3-3	
Electrostatic Discharge	IEC61000-4-2	Level 4 Criteria A <sup>1)</sup> Air Discharge: 15kV Contact Discharge: 8kV
Radiated Field	IEC61000-4-3	Criteria A <sup>1)</sup> 80MHz-2700MHz, 10V/m AM modulation 385MHz-5785MHz, 28V/m Pulse mode and other modulation
Electrical Fast Transient / Burst	IEC61000-4-4	Level 3 Criteria A <sup>1)</sup> :2kV
Surge	IEC61000-4-5	Level 3 Criteria A <sup>1)</sup> Common Mode <sup>3)</sup> : 2kV Differential Mode <sup>4)</sup> : 1kV
Conducted	IEC61000-4-6	Level 2 Criteria A <sup>1)</sup> 150kHz-80MHz, 3Vrms, 6Vrms at ISM bands and Amateur radio bands
Power Frequency Magnetic Fields	IEC61000-4-8	Criteria A <sup>1)</sup> Magnetic field strength 30A/m
Voltage Dips	IEC61000-4-11	Criteria A <sup>1)</sup> 0% U <sub>r</sub> , 0.5 cycle (10ms) , 0°/45°/90°/135°/180°/225°/270°/315°/360°  Criteria A <sup>1)</sup> 0% U <sub>r</sub> , 1 cycle (20ms), 0°  Criteria B <sup>2)</sup> 70% U <sub>r</sub> , 25 cycle (500ms), 0°  Criteria B <sup>2)</sup> 0% U <sub>r</sub> , 250 cycle (5000ms), 0°

1) Criteria A: Normal performance within the specification limits

2) Criteria B: Output out of regulation, or shuts down during test. Automatically restore to normal operation after test.

3) Asymmetrical: Common mode (Line to earth)

4) Symmetrical: Differential mode (Line to line)

# MDS Medical AC-DC Open Frame

## 24Volt, 400Watt / MDS-400AUS24 B

### Block Diagram

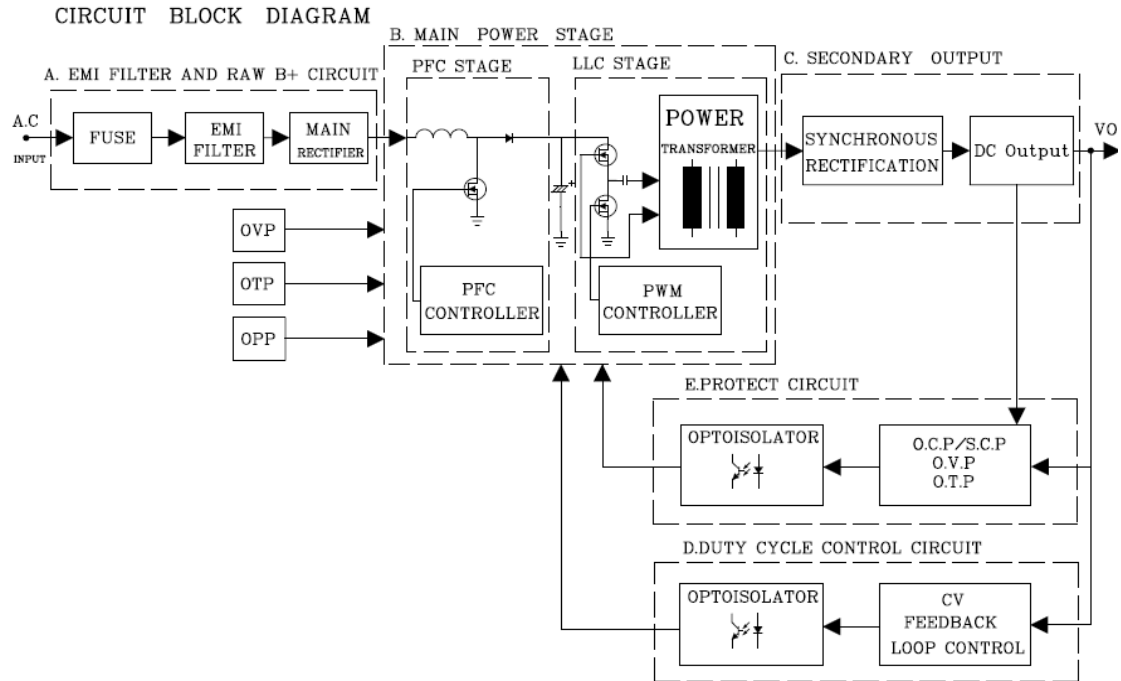

# MDS Medical AC-DC Open Frame

## 24Volt, 400Watt / MDS-400AUS24 B

### Dimensions

L x W x D: 97 x 198 x 41.5 mm

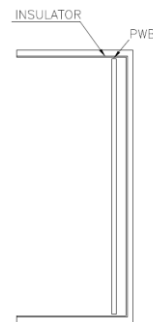
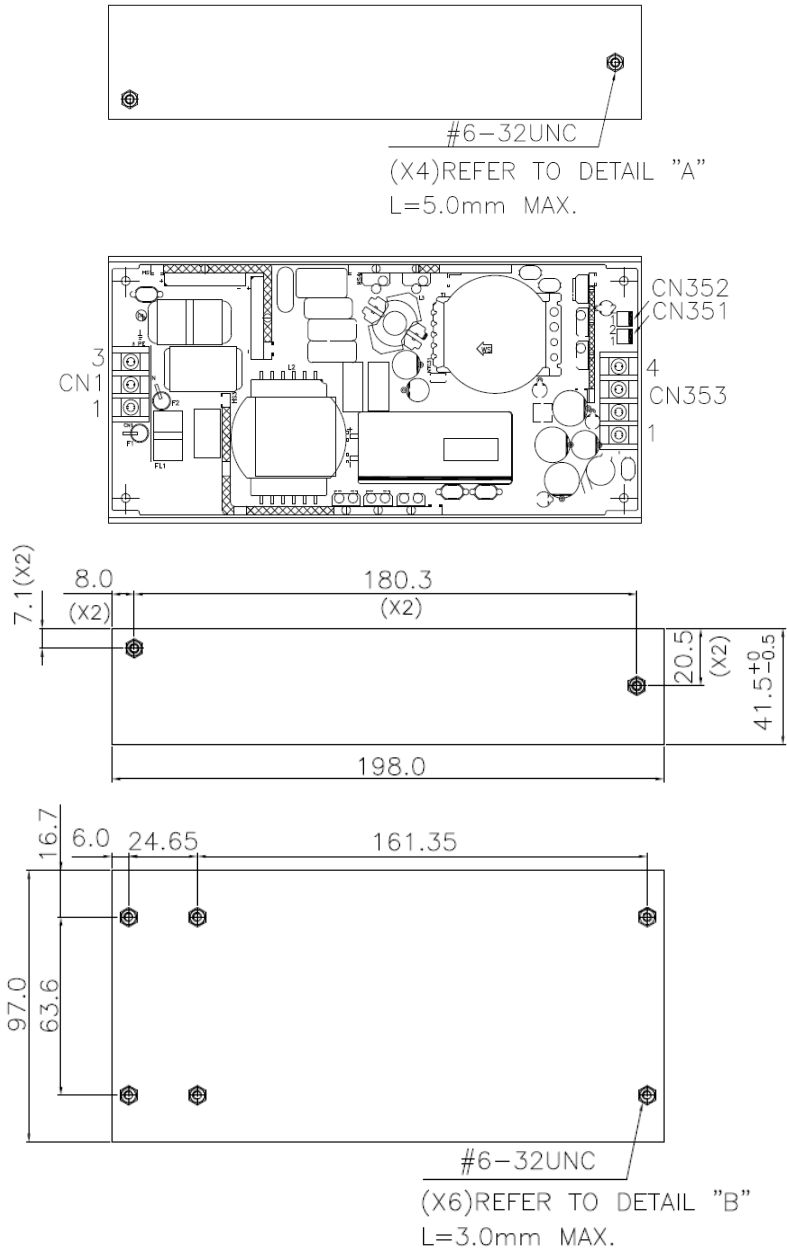

ITEM	PIN NAME	FUNCTION
CN1	1	L
	2	N
	3	PE
CN353	1	V+
	2	
	3	V-
4		
CN352	1	REMOTE SENSE V-
	2	REMOTE SENSE V+
CN351	1	GND (12V/0.25A)
	2	12V

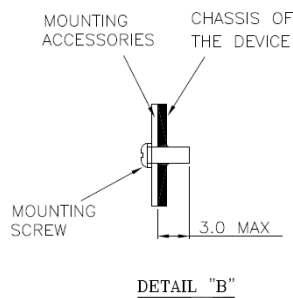
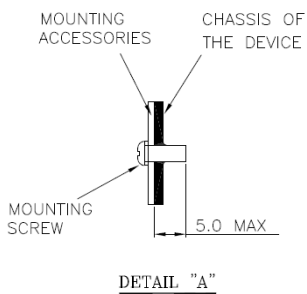

#### Notes

- Dimensions are in mm
- DIMENSION TOLERANCE IS  $\pm$ 0.5

# MDS Medical AC-DC Open Frame

## 24Volt, 400Watt / MDS-400AUS24 B

### De-rating Curve

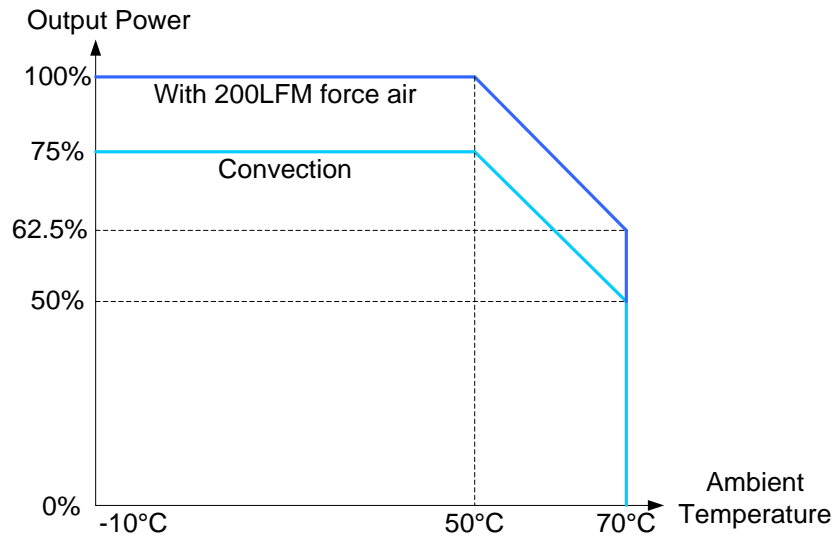

Fig.3

### Functions

#### Start-up Time

The time required for the output voltage ( $V_o$ ) to reach 90% of its set value, after the input AC voltage is applied.

#### Rise Time

The time required for the output voltage ( $V_o$ ) to change from 10% to 90% of its steady state value.

#### Hold-up Time

Hold up time is the time when the AC input collapses and output voltage retains regulation for a certain period of time. The time required for the output to reach 95% of its set value, after the input voltage is removed.

#### ■ Graph illustrating the Start-up Time, Rise Time, and Hold-up Time

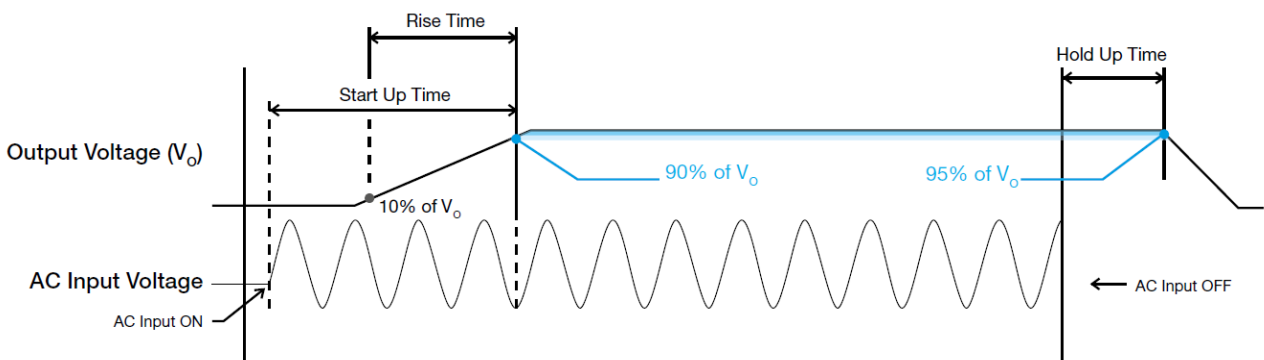



# MDS Medical AC-DC Open Frame

## 24Volt, 400Watt / MDS-400AUS24 B

### Dynamic Response

The power supply output voltage will remain within  $\pm 3\%$  of its steady state value, when subjected to a dynamic load change from 50 to 100% of its rated current.

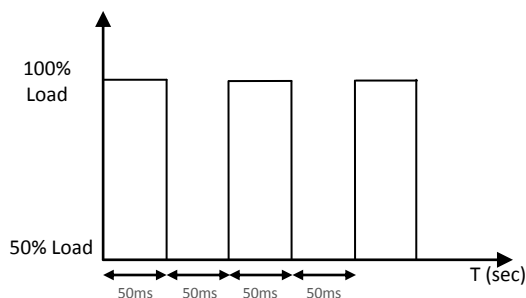

### Inrush Current

Inrush current is the input current that occurs when the input voltage is first applied. For AC input voltages, the maximum peak value of inrush current will occur during the first half cycle of the applied AC voltage. This peak value decreases exponentially during subsequent cycles of AC voltage.

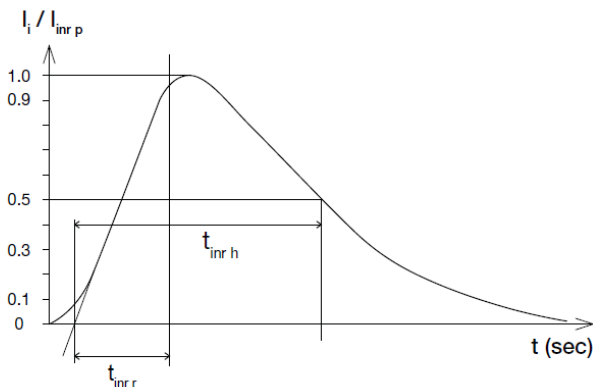

### Overvoltage Protection

The power supply's overvoltage circuit will be activated when its internal feedback circuit fails. The output voltage shall not exceed its specifications defined on Page 3 under "Protections". Power supply will latch off, and require removal/re-application of input AC voltage in order to restart.

### Short Circuit Protection

The power supply's output OLP/OCP function also provides protection against short circuits. When a short circuit is applied, the output current will operate in "Hiccup mode", as shown in the illustration in the OLP/OCP section on this page. The power

supply will return to normal operation after the short circuit is removed.

### Overload & Over current Protections

The power supply's Overload (OLP) and Over current (OCP) Protections will be activated when output current is between 110% and 130% of  $I_o$  (Max load). Upon such an occurrence,  $V_o$  will start to drop. Once the power supply has reached its maximum power limit, the protection will be activated, and the power supply will go into "Hiccup mode" (Auto-Recovery). The power supply will recover once the fault condition causing the OLP and OCP is removed and  $I_o$  is back within the specified limit.

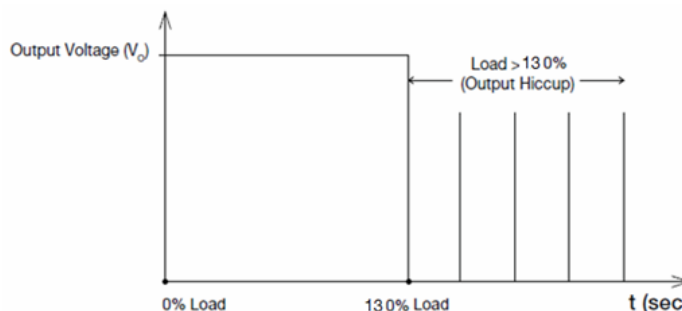

Additionally, if the  $I_o$  is  $< 130\%$  but  $> 110\%$  for a prolonged period of time (depending on the load), the Over Temperature Protection (OTP) will be activated due to high temperature on critical components. The power supply will then go into hiccup mode until the fault is removed; and, the input voltage is removed, then reapplied.

### Over Temperature Protection

As mentioned above, the power supply also has Over Temperature Protection (OTP). This is activated when the overload condition persists for an extended duration and the output current is below the overload trigger point but  $> 100\%$  load. In the event of a higher operating condition at 100% load, the power supply will run into OTP when the surrounding air temperature is higher than the operating temperature. When activated, the output voltage will go into hiccup mode until the input voltage is removed; then, reapplied, and the surrounding air temperature drops to its normal operating temperature.



# MDS Medical AC-DC Open Frame

## 24Volt, 400Watt / MDS-400AUS24 B

### Certificate



All Delta Medical Power products conform to the European directive 2011/65/EU. RoHS is the abbreviation for "Restriction of the use of certain hazardous substances."



Delta has been certified as meeting the requirement of ISO 13485: 2003 and EN ISO 13485:2012 for the design and manufacture of switching power supply and adaptor for medical device.



In addition to a UL Total Certification Program (TCP) approved client laboratory for IEC60950 and IEC60065. Delta also has participated UL Client Test Data Program (CDTP) for IEC 60601