

## Remote I/O R8 Series

### TOTALIZED PULSE INPUT MODULE, 4 points

(NPN / PNP / Voltage pulse input)

#### Functions & Features

- Space-saving remote I/O module of 4 points input pulse counter

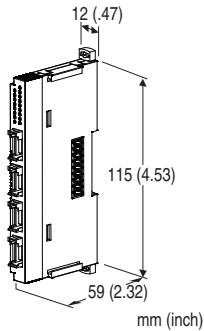

### MODEL: R8-PA4[1][2]

#### ORDERING INFORMATION

- Code number: R8-PA4-[1][2]

Specify a code from below for each [1] and [2].

(e.g. R8-PA4A/Q)

- Specify the specification for option code /Q  
(e.g. /C01)

#### [1] INPUT

A: NPN input

B: PNP input

C: Voltage pulse input

#### [2] OPTIONS

blank: none

/Q: With options (specify the specification)

#### SPECIFICATIONS OF OPTION: Q

**COATING (For the detail, refer to M-System's web site.)**

/C01: Silicone coating

/C02: Polyurethane coating

#### RELATED PRODUCTS

- PC configurator software (model: R8CFG)

Downloadable at M-System's web site.

A dedicated cable is required to connect the module to the PC. Please refer to the internet software download site or the users manual for the PC configurator for applicable cable types.

#### GENERAL SPECIFICATIONS

##### Connection

- **Input:** 4-pin e-CON connector  
PWB connector XN2D-1474-S002 (Omron)  
Recommended cable connector XN2A-1470 (Omron)  
Applicable wire size 0.08 mm<sup>2</sup> (AWG28) - 0.5 mm<sup>2</sup> (AWG20)  
Outer sheath diameter: max. 1.5 dia  
(The cable connector is not included in the package.  
Refer to the specifications of the product.)

##### •Excitation supply, internal bus:

Connected to internal bus connector

- **Internal power:** Supplied from internal bus connector

**Isolation:** Input or exc. supply to internal bus or internal power

**Module address:** With rotary switch

**Terminating resistor:** Built-in (DIP Switch, default: disable)

**Status indicator:** Bi-color (red/green) LED; Refer to the instruction manual.

**Input status indicator:** Green LED; Refer to the instruction manual.

#### INPUT SPECIFICATIONS

**Common:** Positive or negative common (NPN/PNP) per 4 points

**Number of inputs:** 4

**I/O status indicator:** LED turns on with closed contact.

- **NPN/PNP input** (internal supply with excitation supply input from network power module)

**Rated load voltage:** 24 V DC  $\pm 10\%$ ; ripple 5 %p-p max.

**ON voltage / ON resistance:**  $\leq 4$  V (input terminal to COM) /  $\leq 900 \Omega$

**OFF voltage / OFF resistance:**  $\geq 16$  V (input terminal to COM) /  $\geq 10 \text{ k}\Omega$

- **Voltage pulse input**

**Max. input voltage amplitude:** 24 V DC +  $\leq 10\%$

**ON voltage / ON current:**  $\geq 16$  V DC (input terminal to COM) /  $\geq 3.7$  mA

**OFF voltage / OFF current:**  $\leq 5$  V DC (input terminal to COM) /  $\leq 1$  mA

**Input current:**  $\leq 5.5$  mA / point (@24 V DC)

**Input resistance:** Approx. 4.4 k $\Omega$

**ON delay:**  $\leq 2.0$  msec.

**OFF delay:**  $\leq 2.0$  msec.

**Max. Frequency:** 100 Hz

**Minimum ON/OFF pulse requirements:** 5 ms

**Accumulated pulse count:** 0 - 4 294 967 295

**Max. accumulable pulse:** 1 - 4,294,967,295 (factory setting: 4,294,967,295)

**Overflow reset value:** 0 or 1 (factory setting: 0)

## INSTALLATION

**Max. current consumption:** 80 mA  
**Operating temperature:** -10 to +55°C (14 to 131°F)  
**Operating humidity:** 30 to 90 %RH (non-condensing)  
**Atmosphere:** No corrosive gas or heavy dust  
**Mounting:** DIN rail  
**Weight:** 60 g (2.12 oz)

## PERFORMANCE

**Data allocation:** 2  
**Module addresses in use:** 4  
**Power output (input terminal):** Rated current 0.1A DC per channel  
 (rated current 3 A for internal fuse (slow blow fuse  $i^2t$  (A<sup>2</sup>sec) max. 0.31)  
 Total 0.4 A DC  
**Insulation resistance:**  $\geq 100$  M $\Omega$  with 500 V DC  
**Dielectric strength:** 1500 V AC @ 1 minute  
 (input or exc. supply to internal bus or internal power to ground)

## STANDARDS & APPROVALS

**EU conformity:**  
 EMC Directive  
 EMI EN 61000-6-4  
 EMS EN 61000-6-2  
 RoHS Directive  
 EN 50581

## EXTERNAL VIEW

### FRONT VIEW

### SIDE VIEW

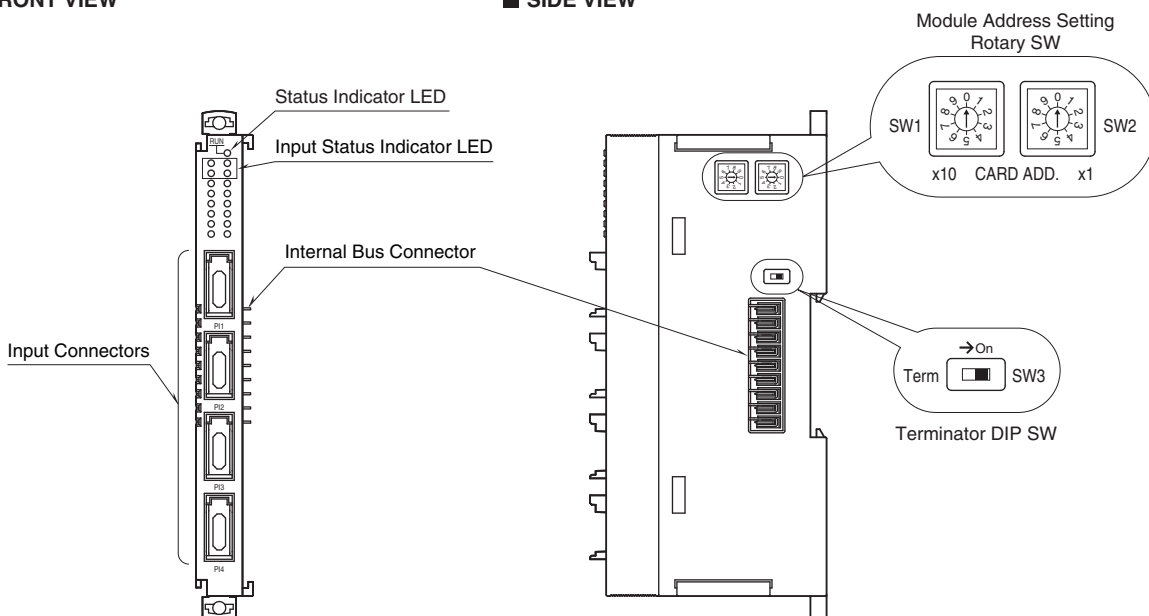

**OPERATING MODE SETTING**

(\*) Factory setting

■ **Module Address**

The left switch determines the tenth place digit, while the right switch does the ones place digit of the address. Address is selected between 0 to 28.

(Factory setting: 0)

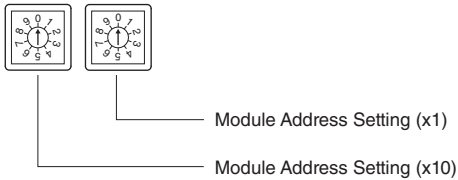

■ **Terminator DIP SW**

TERMINATOR SW	SW3
Without (*)	OFF
With	ON

**DIMENSIONS unit: mm (inch)**

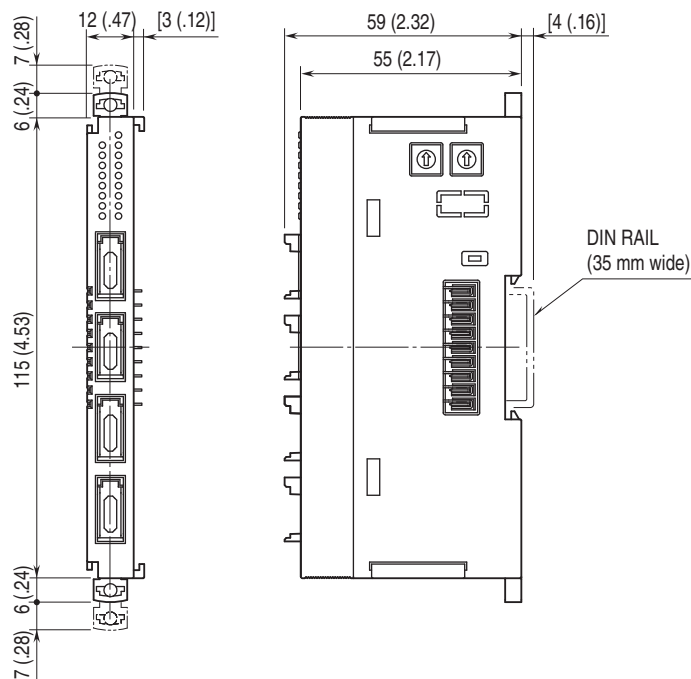

## SCHEMATIC CIRCUITRY & CONNECTION DIAGRAM

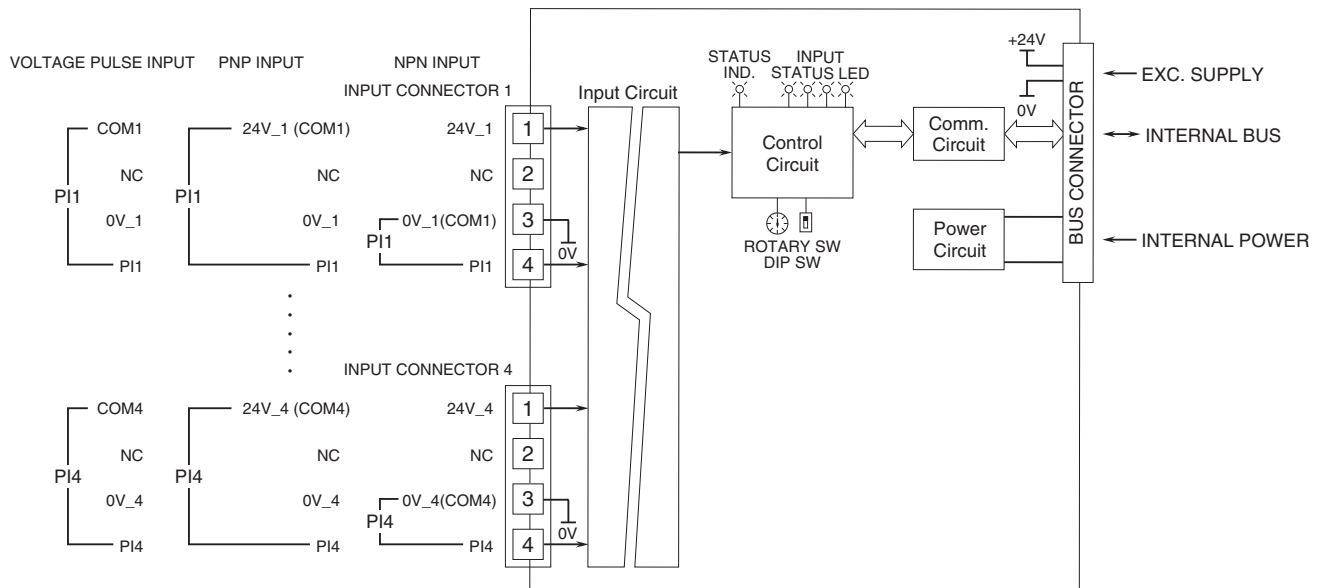

### ■ NPN INPUT

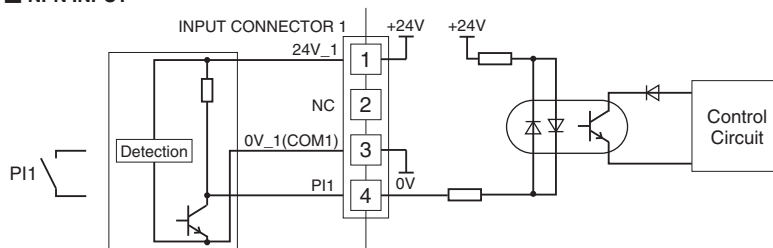

### ■ PNP INPUT

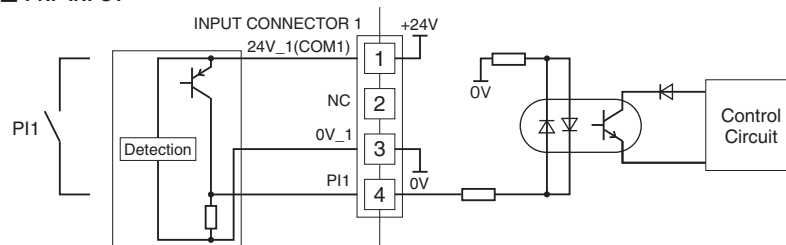

### ■ VOLTAGE PULSE INPUT

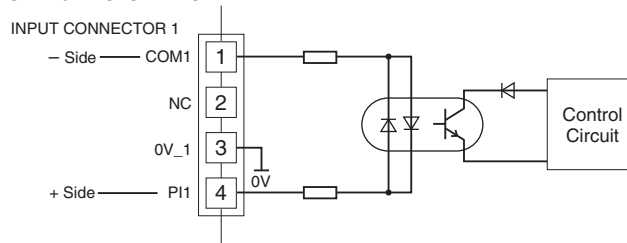

Specifications are subject to change without notice.