

## 100W TO-247 HIGH POWER RESISTORS

### Features

- Non-inductive, high power resistor.
- Thermally enhanced Industry standard TO-247 package.
- Extremely Low thermal resistance, 1.3 °C/W resistor hot spot to metal tab.
- Complete thermal flow design available for easy implementation.
- Superior vibration durability.
- Small thin package for high density PCB installation.
- RoHS compliant.

### Applications

- High frequency circuits and wide band / linear amplifiers.
- Switch mode and industrial RF power sources.
- AC motor control, electronic load and drive circuits.
- Automotive.
- Industrial PC modules (IPM) and measurement systems.
- RF circuit terminations.
- Constant current and precision voltage sources

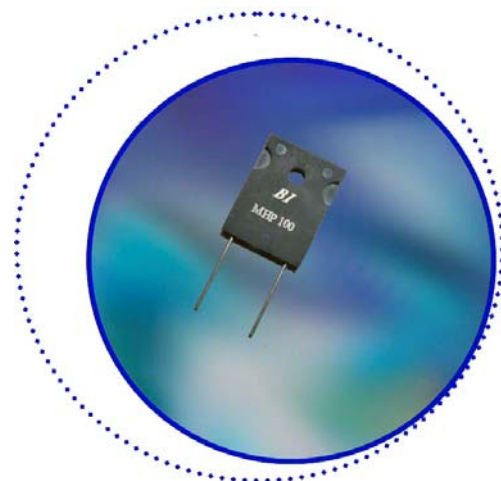

### Specification

#### Dimensions (mm)

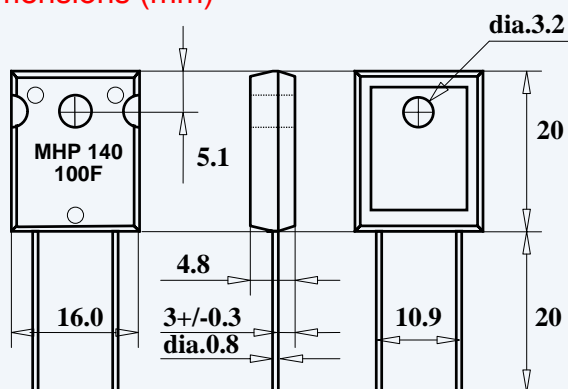

#### Structure and Material

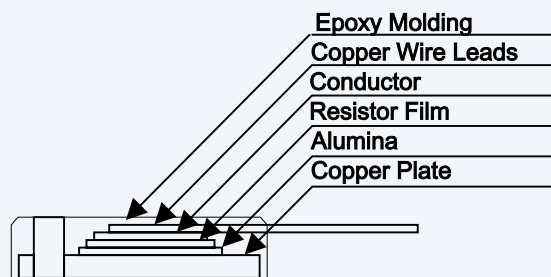

Items	Specification			Conditions
Power Rating	100 Watts			@ Tab Temp < 25°C
Power Rating	3.0 Watts			Free air.
Resistance Range	0.01-0.09 Ω	0.1-9.1 Ω	10-220 Ω	Extended resistance range to 51KΩ avail.
Nominal Resistance Series	E6	E12	E24	2.0 Ω and 5.0 Ω also available.
TCR	250 ppm/°C	100 ppm/°C	50 ppm/°C	For -55 to +155°C
Tolerance	5%	5% and 1%	1%	
Operation Temp. Range	-55 - +155 °C			
Rated Voltage (Max).	700V or $\sqrt{P \cdot R}$			
Dielectric Withstanding Voltage	2500 Volt			60 seconds.
Load Life	$\Delta R \pm (1.0 \% + 0.05 \Omega)$			25°C, 90 min. ON, 30 min. OFF, 1000 hours.
Humidity	$\Delta R \pm (1.0 \% + 0.05 \Omega)$			40°C, 90-95% RH, DC 0.1W, 1000 hours.
Temperature Cycle	$\Delta R \pm (0.25 \% + 0.05 \Omega)$			-55°C, 30 min., +155°C 30min., 5cycles.
Soldering Heat (Max)	$\Delta R \pm (0.25 \% + 0.05 \Omega)$			250+/-5°C, 3 seconds,
Solderability	Min 95% coverage			230+/-5°C, 3 seconds.
Insulation Resistance	Over 1000 MΩ			Between terminals and metal back plate.
Vibration	$\Delta R \pm (0.25 \% + 0.05 \Omega)$			

#### Notes:

1. Electrically isolated metal tab.
2. Recommend the use of thermal grease between metal tab and heat sink.
3. Thermal design should account for a thermal resistance between resistor and tab of 1.3°C/W and a maximum resistor temperature of 155°C.
4. Resistances greater than 220Ω are available, please call factory.
5. For resistances from 220Ω to 51 KΩ the power rating shall be restricted to 50W.
6. Current rating: 25A maximum.

Specifications subject to change without notice.

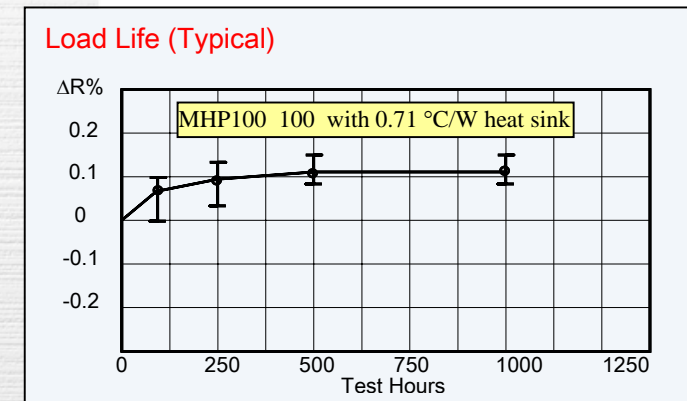
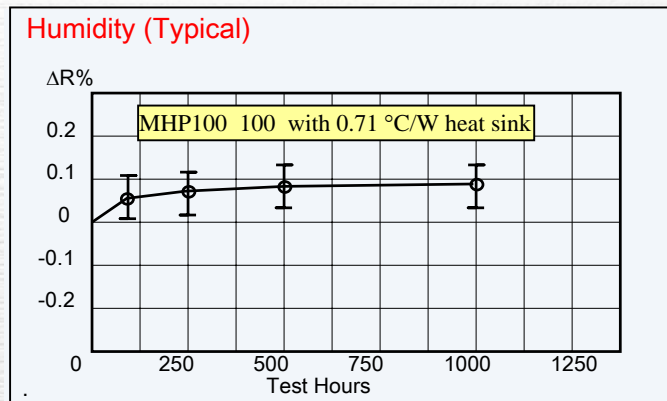
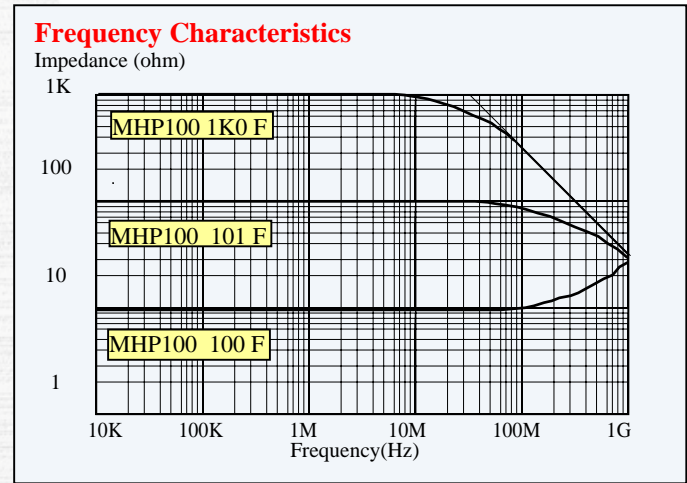
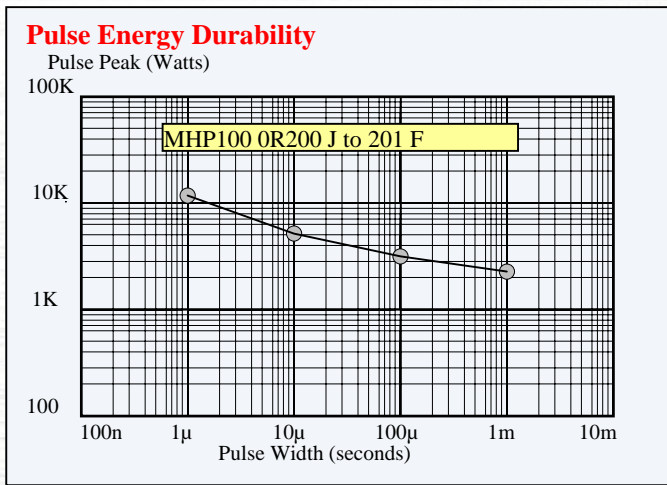
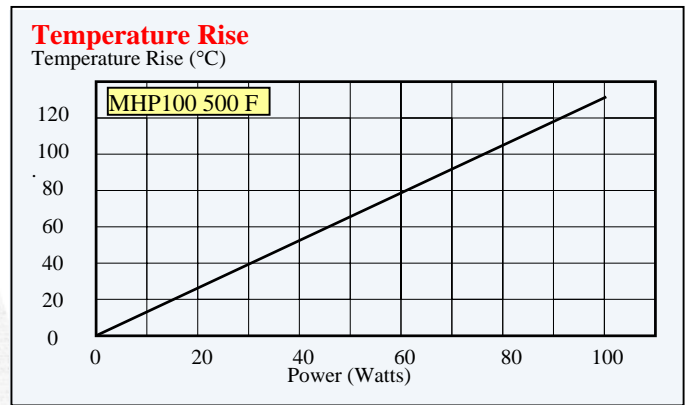
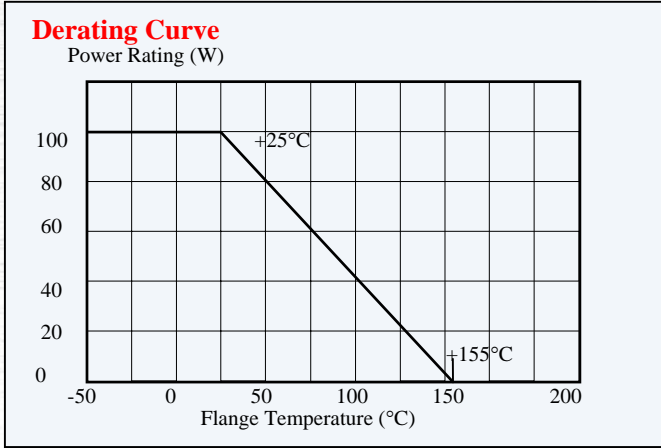

## Ordering Information

<b>MHP 100</b>	<b>500</b>	<b>F</b>
<b>Model</b>		
<b>Resistance Code</b>		<b>Tolerance</b>
0.1Ω : 0R100		J = 5% Tol
50 Ω : 500	First two digits significant, last digit: number of trailing zeros	F = 1% Tol