

Features

- OIP3: 44 dBm
- Gain: 20 dB
- P1dB: 31 dB
- Lead-Free 5 mm 20-lead PQFN Package
- Halogen-Free “Green” Mold Compound
- RoHS* Compliant and 260°C Reflow Compatible
- Class 1C ESD Rating

Description

The MAAP-008924 is a 3-stage, high linearity 1.2 W GaAs power amplifier in a 5mm, 20 lead PQFN package, allowing easy assembly. This PA product is fully matched to 50 ohms on both the input and output. It can be used as a power amplifier stage or as a driver stage in high power applications. It is ideally suited for Point-to-Point Radios.

Each device is 100% RF tested to ensure performance compliance. The part is fabricated using M/A-COM Technology Solutions’ high linearity MESFET Process.

Ordering Information ¹

Part Number	Package
MAAP-008924-TR0500	500 piece reel
MAAP-008924-TR1000	1000 piece reel
MAAP-008924-001SMB	Sample Board

1. Reference Application Note M513 for reel size information.

Functional Schematic

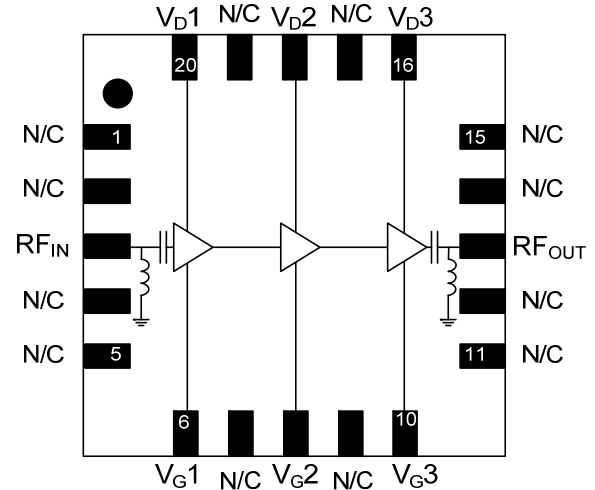

Pin Configuration ^{2,3}

Pin No.	Function	Pin No.	Function
1	No Connect	11	No Connect
2	No Connect	12	No Connect
3	RF _{IN}	13	RF _{OUT}
4	No Connect	14	No Connect
5	No Connect	15	No Connect
6	V _{G1}	16	V _{D3}
7	No Connect	17	No Connect
8	V _{G2}	18	V _{D2}
9	No Connect	19	No Connect
10	V _{G3}	20	V _{D1}

2. M/A-COM Technology Solutions recommends connecting unused package pins to ground.
3. The exposed pad centered on the package bottom must be connected to RF and DC ground.

* Restrictions on Hazardous Substances, European Union Directive 2002/95/EC.

Electrical Specifications: Freq. 10 - 13.3 GHz, $V_{DD} = 6\text{ V}$, $I_{DQ} = 1000\text{ mA}^4$, $Z_0 = 50\ \Omega$

Parameter	Test Conditions	Units	Min.	Typ.	Max.
Small Signal Gain	10 GHz 11.7 GHz 13.3 GHz	dB	— — 20	21 20 22	— — —
Input Return Loss	—	dB	—	12	—
Output Return Loss	—	dB	—	10	—
Noise Figure	—	dB	—	7	—
P1dB	—	dBm	—	31	—
OIP3	10 GHz, @ 15 dBm / tone 11.7 GHz, @ 15 dBm / tone 13.3 GHz, @ 15 dBm / tone	dBm	— — 39	42 44 41	— — —
P_{SAT}	—	dBm	—	32	—
Current, $P_{OUT} = 31\text{ dBm}$	I_{DD}	mA	—	1100	—

4. Set V_{GG} to -1.5 V prior to applying V_{DD} , once V_{DD} is applied adjust V_{GG} to achieve specific I_{DQ} .

Maximum Operating Ratings ^{5,6}

Parameter	Absolute Maximum
Input Power	+12 dBm
Drain Supply Voltage	+7 Volts
Operating Temperature	-40°C to $+85^\circ\text{C}$
Junction Temperature ^{7,8}	$+150^\circ\text{C}$
Storage Temperature	-55°C to $+150^\circ\text{C}$

- Exceeding any one or combination of these limits may cause permanent damage to this device.
- M/A-COM Technology Solutions does not recommend sustained operation near these survivability limits.
- Operating at nominal conditions with $T_J \leq +150^\circ\text{C}$ will ensure $MTTF > 1 \times 10^6$ hours.
- Junction Temperature (T_J) = $T_C + \Theta_{jc} * ((V * I) - (P_{OUT} - P_{IN}))$
Typical thermal resistance (Θ_{jc}) = 9.1°C/W .
 - For $T_C = 25^\circ\text{C}$,
 $T_J = 74^\circ\text{C}$ @ 6 V, 1100 mA, $P_{OUT} = 31\text{ dBm}$, $P_{IN} = 11\text{ dBm}$
 - For $T_C = 85^\circ\text{C}$,
 $T_J = 134^\circ\text{C}$ @ 6 V, 1100 mA, $P_{OUT} = 31\text{ dBm}$, $P_{IN} = 11\text{ dBm}$

Handling Procedures

Please observe the following precautions to avoid damage:

Static Sensitivity

Gallium Arsenide Integrated Circuits are sensitive to electrostatic discharge (ESD) and can be damaged by static electricity. Proper ESD control techniques should be used when handling these class 1C devices.

Typical Performance Curves

Gain

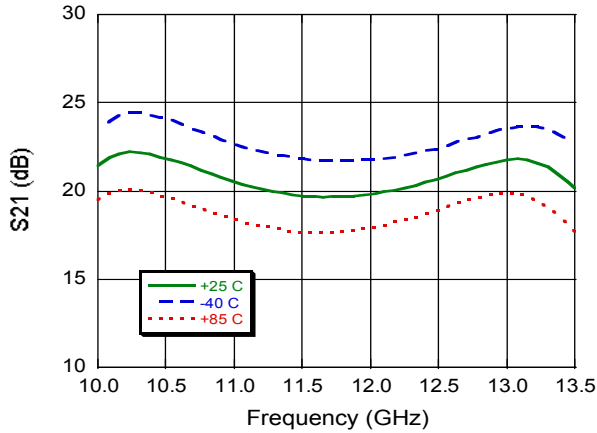

Input Return Loss

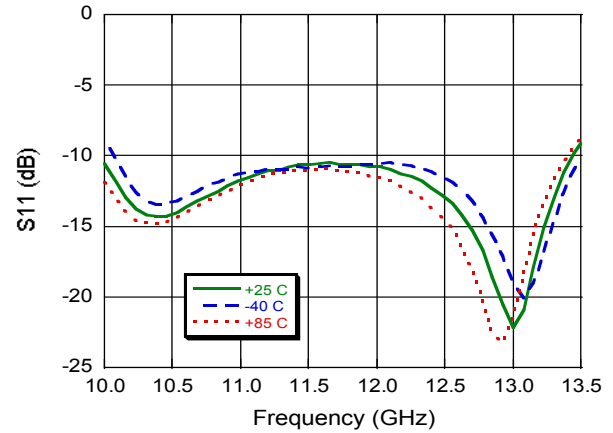

Output Return Loss

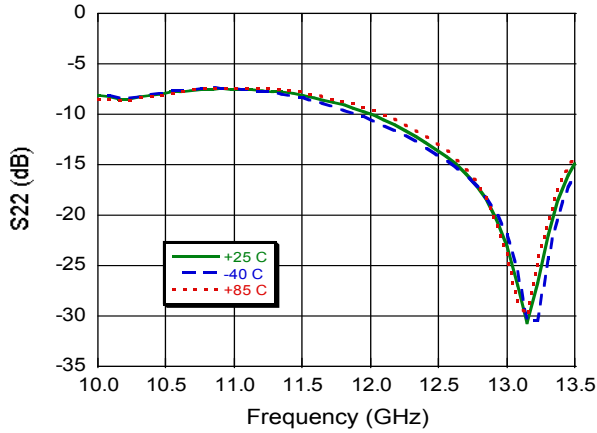

Noise Figure

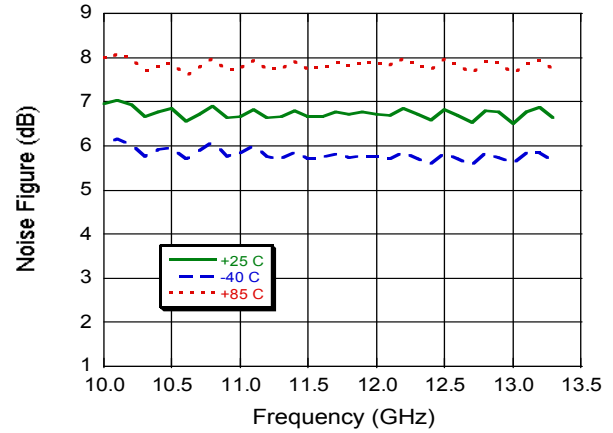

P1dB

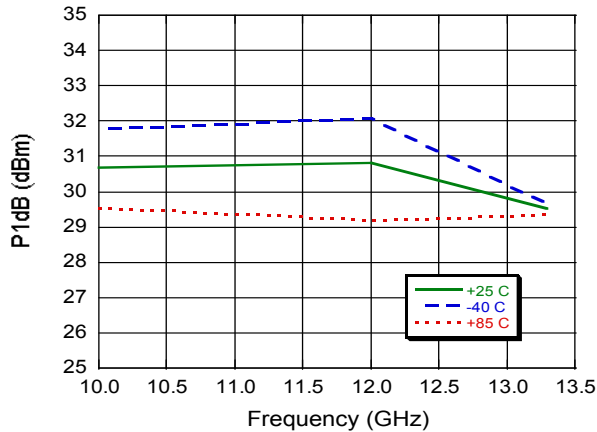

Output IP3 @ 10 GHz

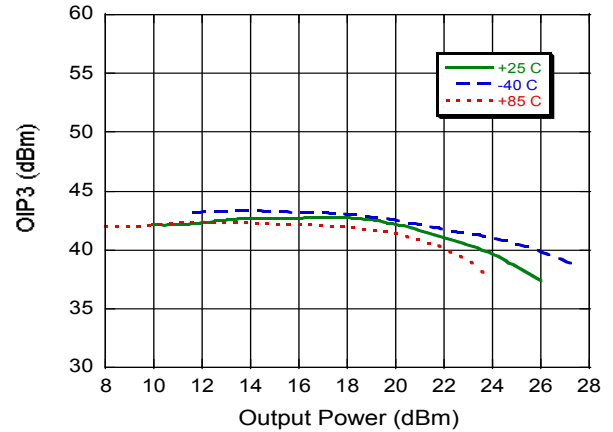

Typical Performance Curves (cont.)

Output IP3 @ 11.7 GHz

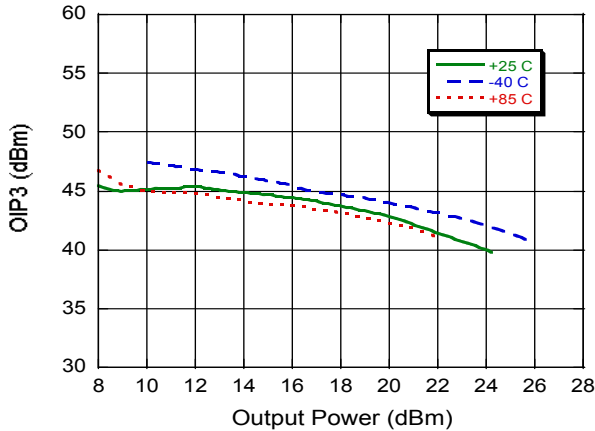

Output IP3 @ 13.3 GHz

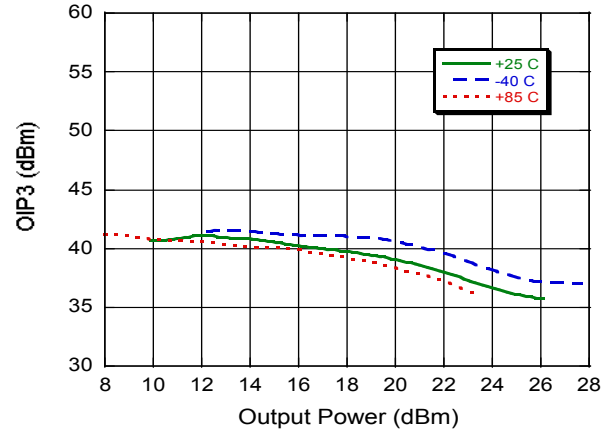

Lead-Free 5 mm 20-Lead PQFN†

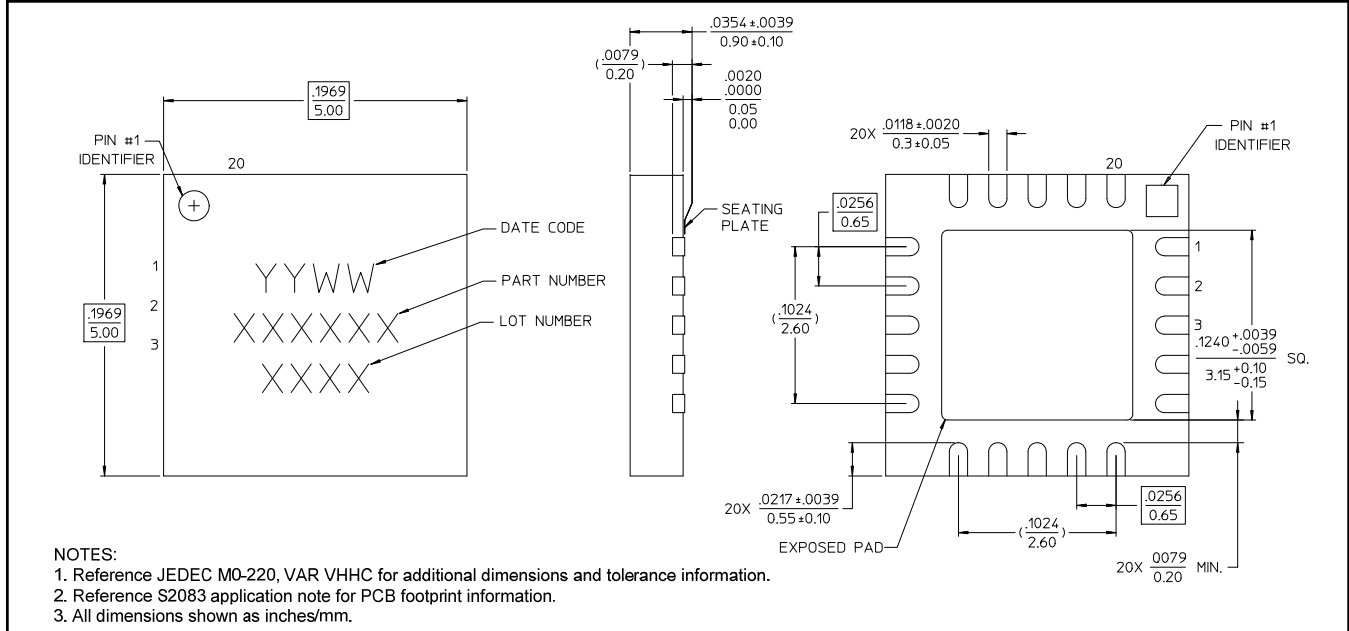

† Reference Application Note S2083 for lead-free solder reflow recommendations.
 Meets JEDEC moisture sensitivity level 1 requirements.
 Plating is 100% matte tin over copper.