

Features

- 600 watts Peak Pulse Power (10/1000 μ s)
- Unidirectional and Bidirectional Protection
- Fast Response Time : Typically < 1ps
- Excellent Clamping Capability
- Glass Passivated Junction
- Built-in Strain relief
- Low inductance
- Low profile package
- High temperature solder:260°C/20 seconds at terminal

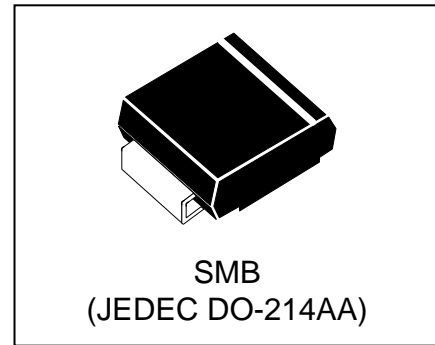

Mechanical Characteristics

- JEDEC DO-214AA(SMBJ) package
- Molding compound flammability rating: UL 94V-0
- Marking : Marking Code
- Packaging : Tape and Reel per EIA 481
- RoHS/WEEE Compliant

Applications

- I/O Interfaces
- Power lines
- Automotive and Telecommunication
- Computers & Consumer Electronics
- Industrial Electronics

Absolute Maximum Rating			
Rating	Symbol	Value	Units
Peak Pulse Power (tp =10/1000 μ s) (see Note1,2& 3)	P _{PPM}	600	Watts
Peak pulse current (10/1000 μ s) (see Note2&3)	I _{PPM}	See Electrical Characteristics	A
Peak Forward surge current (see Note4&5)	I _{FSM}	100	A
Power Dissipation on infinite heat sink T _A = 50 °C (Fig5)	P _D	5.0	W
Operating Junction Temperature range	T _J	-65 to + 150	°C
Storage Temperature range	T _{STG}	-65 to + 150	°C

Note1: Peak Pulse Power Rating as Pulse Width ,per Fig1.

Note2: Peak Pusle Power or Current Derated above T_A=25°C Per Fig. 2 and Non-Repetitive Current Pulse,Per Fig.3.

Note3: Mounted on 5.0x5.0mm² copper pad to each terminal.

Note4: 8.3ms Single Half Sine Wave or Equivalent Square Wave.

Note5: Maximum Forward Surge Current only for Unidirectional Device per Fig6.

Electrical Characteristics

Part Number		Reverse Stand off Voltage V_{RWM} (Volts)	Breakdown Voltage V_{BR} (Volts)@ I_T		Test Current I_T (mA)	Maximum Clamping Voltage V_c @ I_{PP} (Volts)	Maximum PeakPulse Current I_{pp} (Amps)	Maximum Reverse Leakage I_R @ V_{RWM} (μ A)
			MIN	MAX				
UNI-POLAR	BI-POLAR							
SMBJ5.0A	SMBJ5.0CA	5.0	6.40	7.07	10	9.2	65.2	50
SMBJ6.0A	SMBJ6.0CA	6.0	6.67	7.37	10	10.3	58.3	50
SMBJ6.5A	SMBJ6.5CA	6.5	7.22	7.98	10	11.2	53.6	50
SMBJ7.0A	SMBJ7.0CA	7.0	7.78	8.60	10	12.0	50.0	50
SMBJ7.5A	SMBJ7.5CA	7.5	8.33	9.21	1	12.9	46.5	50
SMBJ8.0A	SMBJ8.0CA	8.0	8.89	9.83	1	13.6	44.1	20
SMBJ8.5A	SMBJ8.5CA	8.5	9.44	10.40	1	14.4	41.7	10
SMBJ9.0A	SMBJ9.0CA	9.0	10.00	11.10	1	15.4	39.0	5
SMBJ10A	SMBJ10CA	10	11.10	12.30	1	17.0	35.3	2
SMBJ11A	SMBJ11CA	11	12.20	13.50	1	18.2	33.0	1
SMBJ12A	SMBJ12CA	12	13.30	14.7	1	19.9	30.2	1
SMBJ13A	SMBJ13CA	13	14.40	15.90	1	21.5	27.9	1
SMBJ14A	SMBJ14CA	14	15.60	17.20	1	23.2	25.9	1
SMBJ15A	SMBJ15CA	15	16.70	18.50	1	24.4	24.6	1
SMBJ16A	SMBJ16CA	16	17.80	19.70	1	26.0	23.1	1
SMBJ17A	SMBJ17CA	17	18.90	20.90	1	27.6	21.7	1
SMBJ18A	SMBJ18CA	18	20.00	22.10	1	29.2	20.5	1
SMBJ20A	SMBJ20CA	20	22.20	24.50	1	32.4	18.5	1
SMBJ22A	SMBJ22CA	22	24.40	26.90	1	35.5	16.9	1
SMBJ24A	SMBJ24CA	24	26.70	29.50	1	38.9	15.4	1
SMBJ26A	SMBJ26CA	26	28.90	31.90	1	42.1	14.3	1
SMBJ28A	SMBJ28CA	28	31.10	34.40	1	45.4	13.2	1
SMBJ30A	SMBJ30CA	30	33.30	36.80	1	48.4	12.4	1
SMBJ33A	SMBJ33CA	33	36.70	40.60	1	53.3	11.3	1
SMBJ36A	SMBJ36CA	36	40.00	44.20	1	58.1	10.3	1
SMBJ40A	SMBJ40CA	40	44.40	49.10	1	64.5	9.3	1
SMBJ43A	SMBJ43CA	43	47.80	52.80	1	69.4	8.6	1

Electrical Characteristics (Cont.)

Part Number		Reverse Stand off Voltage V_{RWM} (Volts)	Breakdown Voltage $V_{BR}(\text{Volts})@I_T$		Test Current I_T (mA)	Maximum Clamping Voltage $V_C@I_{PP}$ (Volts)	Maximum PeakPulse Current I_{pp} (Amps)	Maximum Reverse Leakage $I_R@V_{RWM}$ (μA)
UNI-POLAR	BI-POLAR		MIN	MAX				
SMBJ45A	SMBJ45CA	45	50.00	55.30	1	72.7	8.3	1
SMBJ48A	SMBJ48CA	48	53.30	58.90	1	77.4	7.8	1
SMBJ51A	SMBJ51CA	51	56.70	62.70	1	82.4	7.3	1
SMBJ54A	SMBJ54CA	54	60.00	66.30	1	87.1	6.9	1
SMBJ58A	SMBJ58CA	58	64.40	71.20	1	93.6	6.4	1
SMBJ60A	SMBJ60CA	60	66.70	73.70	1	96.8	6.2	1
SMBJ64A	SMBJ64CA	64	71.10	78.60	1	103	5.8	1
SMBJ70A	SMBJ70CA	70	77.80	86.00	1	113	5.3	1
SMBJ75A	SMBJ75CA	75	83.30	92.10	1	121	5.0	1
SMBJ78A	SMBJ78CA	78	86.70	95.80	1	126	4.8	1
SMCJ85A	SMCJ85CA	85	94.40	104	1	137	4.4	1
SMBJ90A	SMBJ90CA	90	100	111	1	146	4.1	1
SMBJ100A	SMBJ100CA	100	111	123	1	162	3.7	1
SMBJ110A	SMBJ110CA	110	122	135	1	177	3.4	1
SMBJ120A	SMBJ120CA	120	133	147	1	193	3.1	1
SMBJ130A	SMBJ130CA	130	144	159	1	209	2.9	1
SMBJ150A	SMBJ150CA	150	167	185	1	243	2.5	1
SMBJ160A	SMBJ160CA	160	178	197	1	259	2.3	1
SMBJ170A	SMBJ170CA	170	189	209	1	275	2.2	1
SMBJ180A	SMBJ180CA	180	201	222	1	292	2.1	1
SMBJ200A	SMBJ200CA	200	224	247	1	324	1.9	1
SMBJ220A	SMBJ220CA	220	246	272	1	356	1.7	1
SMBJ250A	SMBJ250CA	250	279	309	1	405	1.5	1
SMBJ300A	SMBJ300CA	300	335	371	1	486	1.3	1
SMBJ350A	SMBJ350CA	350	391	432	1	567	1.1	1

Typical Characteristics

Figure 1: Peak Pulse Power Rating Curve

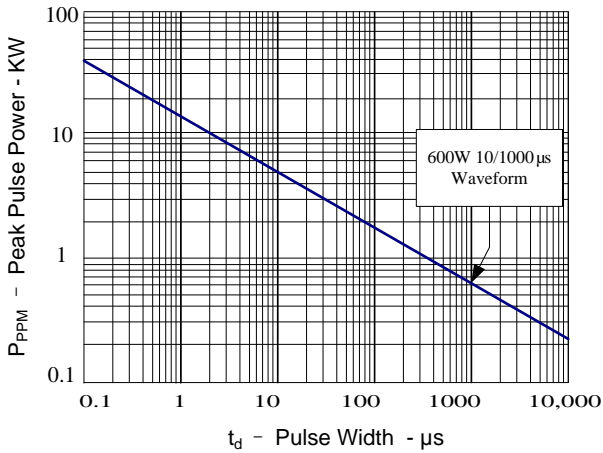

Figure 2: Pulse Derating Curve

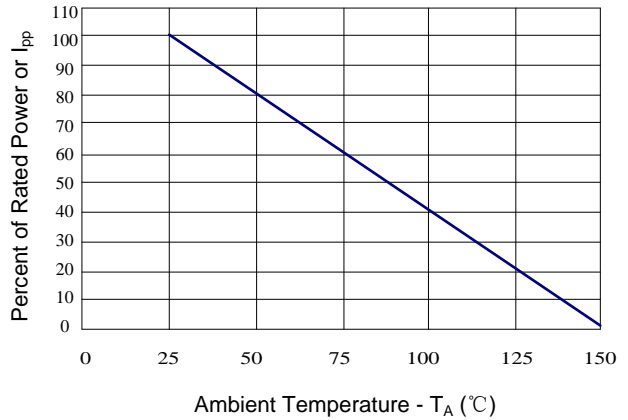

Figure 3: Pulse Waveform

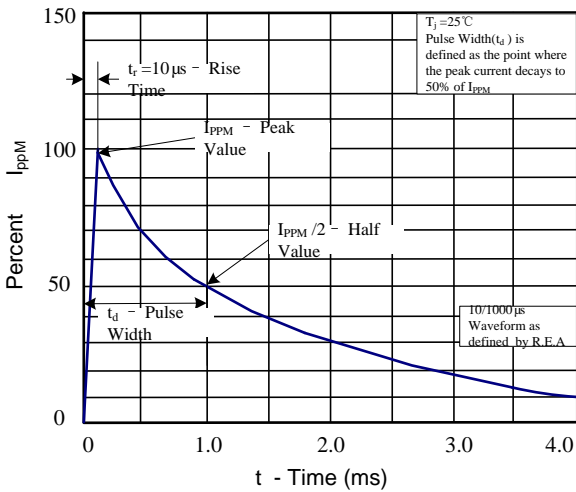

Figure 4: Typical Junction Capacitance

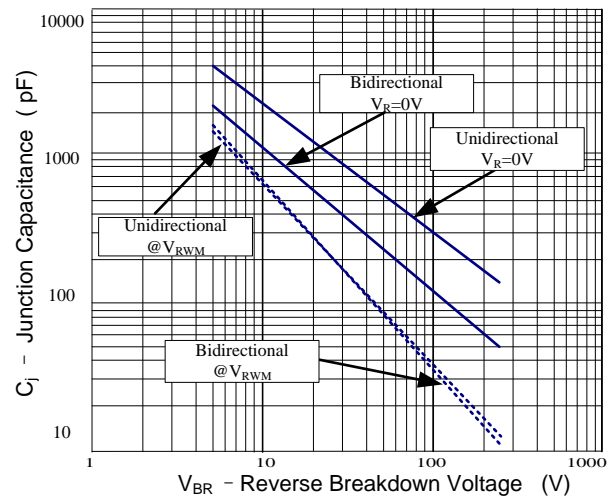

Figure 5: Steady State Power Dissipation Derating Curve

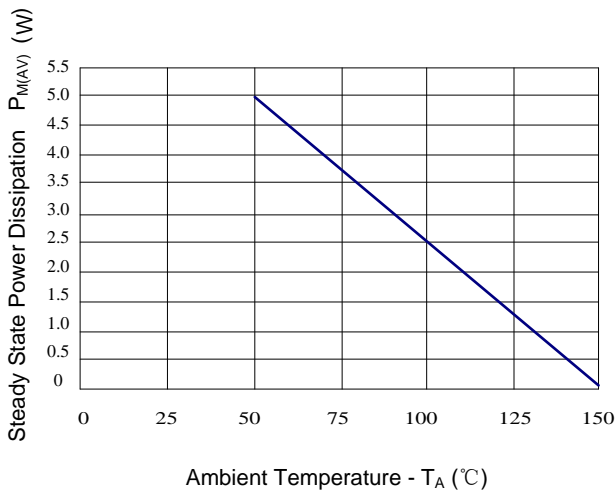
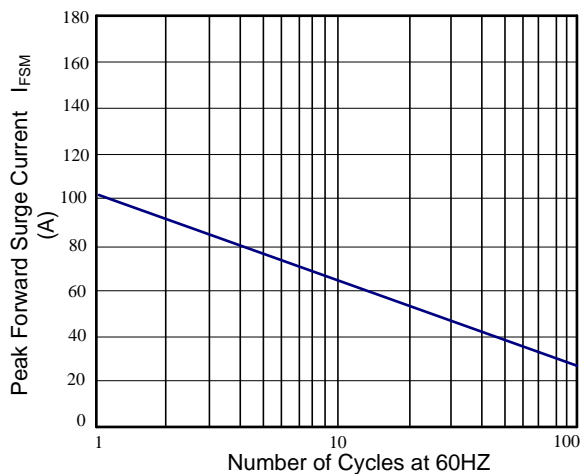

Figure 6: Maximum Non-Repetitive Forward Surge Current Only Unidirectional





Outline Drawing – SMBJ(DO-214AA)

Ref. (mm)	Millimeters	
	Min.	Max.
A	2.130	2.440
A1	-	0.203
B	1.950	2.200
E	4.060	4.570
E1	0.152	0.305
D	3.300	3.940
L	0.760	1.520

