



EEPROM-Programmable Hex/Quad Power-Supply Sequencers/Supervisors with ADC

General Description

The MAX6870/MAX6871 EEPROM-configurable, multi-voltage supply sequencers/supervisors monitor several voltage detector inputs, two auxiliary inputs, and four general-purpose logic inputs. The MAX6870/MAX6871 feature programmable outputs for highly configurable power-supply sequencing applications. The MAX6870 features six voltage detector inputs and eight programmable outputs, while the MAX6871 features four voltage detector inputs and five programmable outputs. Manual reset and margin disable inputs offer additional flexibility.

All voltage detectors offer two configurable thresholds for undervoltage/overvoltage or dual undervoltage detection. One high voltage input (IN1) provides detector threshold voltages from +2.5V to +13.2V in 50mV increments, or from +1.25V to +7.625V in 25mV increments. A bipolar input (IN2) provides detector threshold voltages from $\pm 2.5V$ to $\pm 15.25V$ in 50mV increments, or from $\pm 1.25V$ to $\pm 7.625V$ in 25mV increments. Positive inputs (IN3–IN6) provide detector threshold voltages from +1V to +5.5V in 20mV increments, or from +0.5V to +3.05V in 10mV increments.

Programmable output stages control power-supply sequencing or system resets/interrupts. Programmable output options include: active-high, active-low, open-drain, weak pullup, push-pull, and charge pump. Programmable timing delay blocks configure each output to wait between 25 μ s and 1600ms before deasserting. A fault register logs the condition that caused each output to assert (undervoltage, overvoltage, manual reset, etc.).

An internal 10-bit ADC monitors the voltage detector inputs, and two auxiliary inputs through a multiplexer that automatically sequences through all inputs every 200ms. A SMBus™/I²C™-compatible, serial data interface programs and communicates with the configuration EEPROM, the configuration registers, the internal 4kb user EEPROM, the ADC registers, and the fault registers of the MAX6870/MAX6871.

The MAX6870/MAX6871 are available in a 7mm x 7mm x 0.8mm 32-pin thin QFN package and operate over the extended -40°C to +85°C temperature range.

Applications

- Telecommunications/Central Office Systems
- Networking Systems
- Servers/Workstations
- Basestations
- Storage Equipment
- Multimicroprocessor/Voltage Systems

Pin Configurations, Typical Operating Circuit, and Selector Guide appear at end of data sheet.



Features

- ◆ **Six (MAX6870) or Four (MAX6871) Configurable Input Voltage Detectors**
 - One High Voltage Input (+1.25V to +7.625V or +2.5V to +13.2V Thresholds)
 - One Bipolar Voltage Input ($\pm 1.25V$ to $\pm 7.625V$ or $\pm 2.5V$ to $\pm 15.25V$ Thresholds)
 - Four (MAX6870) or Two (MAX6871) Positive Voltage Inputs (+0.5V to +3.05V or +1V to +5.5V Thresholds)
- ◆ **Four General-Purpose Logic Inputs**
- ◆ **Two Configurable Watchdog Timers**
- ◆ **Eight (MAX6870) or Five (MAX6871) Programmable Outputs**
 - Active-High, Active-Low, Open-Drain, Weak Pullup, Push-Pull, Charge-Pump
 - Timing Delays from 25 μ s to 1600ms
- ◆ **10-Bit Internal ADC Monitors the Input Voltage Detectors and Two Auxiliary Inputs**
- ◆ **Margining Disable and Manual Reset Controls**
- ◆ **Internal 1.25V Reference or External Reference Input**
- ◆ **4kb Internal User EEPROM**
 - Endurance: 100,000 Erase/Write Cycles
 - Data Retention: 10 Years
- ◆ **I²C/SMBus-Compatible Serial Configuration/Communication Interface**
- ◆ **$\pm 1\%$ Threshold Accuracy**

Ordering Information

PART	TEMP RANGE	PIN-PACKAGE	PKG CODE
MAX6870ETJ	-40°C to +85°C	32 Thin QFN	T3277-2
MAX6871ETJ	-40°C to +85°C	32 Thin QFN	T3277-2

SMBus is a trademark of Intel Corp.

I²C is a trademark of Philips Corp.

Purchase of I²C components from Maxim Integrated Products, Inc., or one of its sublicensed Associated Companies, conveys a license under the Philips I²C Patent Rights to use these components in an I²C system, provided that the system conforms to the I²C Standard Specification as defined by Philips.

MAX6870/MAX6871

Maxim Integrated Products 1

For pricing, delivery, and ordering information, please contact Maxim/Dallas Direct! at 1-888-629-4642, or visit Maxim's website at www.maxim-ic.com.

EEPROM-Programmable Hex/Quad Power-Supply Sequencers/Supervisors with ADC

MAX6870/MAX6871

ABSOLUTE MAXIMUM RATINGS

All Voltages referenced to GND
 IN3–IN6, ABP, SDA, SCL, A0, A1,
 GPI1–GPI4, MR, MARGIN, PO5–PO8
 (MAX6870), PO3/PO4/PO5 (MAX6871).....-0.3V to +6V
 IN1, PO1–PO4 (MAX6870), PO1/PO2 (MAX6871).....-0.3V to +14V
 IN2-20V to +20V
 DBP, AUXIN1, AUXIN2, REFIN.....-0.3V to +3V
 Input/Output Current (all pins).....±20mA

Continuous Power Dissipation ($T_A = +70^\circ\text{C}$)
 32-Pin 7mm x 7mm Thin QFN
 (derate 33.3mW/°C above +70°C).....2667mW
 Operating Temperature Range-40°C to +85°C
 Maximum Junction Temperature+150°C
 Storage Temperature Range-65°C to +150°C
 Lead Temperature (soldering, 10s)+300°C

Stresses beyond those listed under "Absolute Maximum Ratings" may cause permanent damage to the device. These are stress ratings only, and functional operation of the device at these or any other conditions beyond those indicated in the operational sections of the specifications is not implied. Exposure to absolute maximum rating conditions for extended periods may affect device reliability.

ELECTRICAL CHARACTERISTICS

($V_{IN1} = +6.5\text{V}$ to +13.2V, $V_{IN2} = +10\text{V}$, V_{IN3} to $V_{IN6} = +2.7\text{V}$ to +5.5V, $\text{AUXIN}_- = \text{GPI}_- = \text{GND}$, $\overline{\text{MARGIN}} = \overline{\text{MR}} = \text{DBP}$, $T_A = -40^\circ\text{C}$ to +85°C, unless otherwise noted. Typical values are at $T_A = +25^\circ\text{C}$.) (Notes 1 and 2)

PARAMETER	SYMBOL	CONDITIONS	MIN	TYP	MAX	UNITS
Operating Voltage Range (Note 3)	V_{IN1}	Voltage on IN1 to ensure the device is fully operational, IN3 to IN6 = GND	4.0		13.2	V
	V_{IN3} to V_{IN6}	Voltage on any one of IN3 to IN6 to ensure the device is fully operational, IN1 = GND	2.7		5.5	
IN1 Supply Voltage (Note 3)	V_{IN1P}	Minimum voltage on IN1 to guarantee that the device is powered through IN1			6.5	V
Undervoltage Lockout	V_{UVLO}	Minimum voltage on one of IN3 to IN6 to guarantee the device is EEPROM configured.			2.5	V
Supply Current	I_{CC}	$V_{IN1} = +13.2\text{V}$, IN2 to IN6 = GND, no load		1.2	1.5	mA
		Writing to configuration registers or EEPROM, no load		1.3	2	
Threshold Range	V_{TH}	V_{IN1} (50mV increments)	2.5		13.2	V
		V_{IN1} (25mV increments)	1.250		7.625	
		V_{IN2} (50mV increments)	±2.50		±15.25	
		V_{IN2} (25mV increments)	±1.250		±7.625	
		V_{IN3} to V_{IN6} (20mV increments)	1.0		5.5	
		V_{IN3} to V_{IN6} (10mV increments)	0.50		3.05	
Threshold Accuracy		IN1 to IN6 positive, V_{IN}_- falling	$T_A = +25^\circ\text{C}$	-1.0	+1.0	%
			$T_A = -40^\circ\text{C}$ to +85°C	-1.5	+1.5	
		-15.25V ≤ V_{IN2} ≤ -5V, V_{IN2} falling	$T_A = +25^\circ\text{C}$	-1.5	+1.5	mV
			$T_A = -40^\circ\text{C}$ to +85°C	-2	+2	
-5V ≤ V_{IN2} ≤ 0, V_{IN2} falling	$T_A = +25^\circ\text{C}$	-75	+75	mV		
	$T_A = -40^\circ\text{C}$ to +85°C	-100	+100			
Threshold Hysteresis	$V_{TH-HYST}$			0.3		% V_{TH}
Reset Threshold Temperature Coefficient	$\Delta V_{TH}/^\circ\text{C}$			10		ppm/°C
Threshold-Voltage Differential Nonlinearity	$V_{TH DNL}$			-1	+1	LSB

EEPROM-Programmable Hex/Quad Power-Supply Sequencers/Supervisors with ADC

MAX6870/MAX6871

ELECTRICAL CHARACTERISTICS (continued)

($V_{IN1} = +6.5V$ to $+13.2V$, $V_{IN2} = +10V$, V_{IN3} to $V_{IN6} = +2.7V$ to $+5.5V$, $AUXIN_ = GPI_ = GND$, $\overline{MARGIN} = \overline{MR} = DBP$, $T_A = -40^{\circ}C$ to $+85^{\circ}C$, unless otherwise noted. Typical values are at $T_A = +25^{\circ}C$.) (Notes 1 and 2)

PARAMETER	SYMBOL	CONDITIONS	MIN	TYP	MAX	UNITS	
IN1 Input Leakage Current	I_{LIN1}	For $V_{IN1} <$ the highest of V_{IN3} to V_{IN6}		100	140	μA	
IN2 Input Impedance	R_{IN2}		160	230	320	$k\Omega$	
IN3 to IN6 Input Impedance	R_{IN3} to R_{IN6}	$V_{IN1} > 6.5V$	70	100	145	$k\Omega$	
Power-Up Delay	t_{PU}	$V_{ABP} \geq V_{UVLO}$			3.5	ms	
IN_ to PO_ Delay	t_{DPO}	$V_{IN_}$ falling or rising, 100mV overdrive		25		μs	
PO_ Timeout Period	t_{RP}	Register contents (Table 25)	000	25		μs	
			001	1.406	1.5625	1.719	ms
			010	5.625	6.25	6.875	
			011	22.5	25	27.5	
			100	45	50	55	
			101	180	200	220	
			110	360	400	440	
			111	1440	1600	1760	
PO1–PO4 (MAX6870), PO1/PO2 (MAX6871) Output Low (Note 3)	V_{OL}	$V_{ABP} \geq +2.5V$, $I_{SINK} = 500\mu A$			0.3	V	
		$V_{ABP} \geq +4.0V$, $I_{SINK} = 2mA$			0.4		
PO5–PO8 (MAX6870), PO3/PO4/PO5 (MAX6871) Output Low (Note 3)	V_{OL}	$V_{ABP} \geq +2.5V$, $I_{SINK} = 1mA$			0.3	V	
		$V_{ABP} \geq +4.0V$, $I_{SINK} = 4mA$			0.4		
PO1–PO8 Output Initial Pulldown Current	I_{PD}	$V_{ABP} \leq V_{UVLO}$, $V_{PO_} = 0.8V$		10	40	μA	
PO1–PO8 Output Open-Drain Leakage Current	I_{LKG}	Output high impedance	-1		+1	μA	
PO1–PO8 Output Pullup Resistance, Weak Pullup Selected	R_{PU}	$V_{PO_} = 2V$	6.6	10	15.0	$k\Omega$	
PO1–PO4 (MAX6870), PO1/PO2 (MAX6871) Turn-On Time, Charge Pump Selected (Note 4)	t_{ON}	$C_{PO_} = 1500pF$, $V_{ABP} = +3.3V$, $V_{PO_} = +7.8V$	0.5	1.5	3.0	ms	
PO1–PO4 (MAX6870), PO1/PO2 (MAX6871) Turn-Off Time, Charge Pump Selected	t_{OFF}	$C_{PO_} = 1500pF$, $V_{ABP} = +3.3V$, $V_{PO_} = +0.5V$		30		μs	
PO1–PO4 (MAX6870), PO1/PO2 (MAX6871) Output High, Charge Pump Selected (Notes 3, 4)	V_{OHCP}	With respect to V_{ABP} , $I_{PO_} < 100nA$		5.5		V	
		With respect to V_{ABP} , $I_{PO_} < 1\mu A$	4.0	5.0	6.0		
PO5–PO8 (MAX6870), PO3/PO4/PO5 (MAX6871) Output High, Push-Pull Selected (Note 3)	V_{OH}	Any one of V_{IN3} to $V_{IN6} \geq +2.7V$, $I_{SOURCE} = 10mA$, output pulled up to the same $IN_$	1.5			V	
		Any one of V_{IN3} to $V_{IN6} \geq +2.7V$, $I_{SOURCE} = 1mA$, output pulled up to the same $IN_$	$0.8 \times V_{IN_}$				
		Any one of V_{IN3} to $V_{IN6} \geq +4.5V$, $I_{SOURCE} = 2mA$, output pulled up to the same $IN_$	$0.8 \times V_{IN_}$				

EEPROM-Programmable Hex/Quad Power-Supply Sequencers/Supervisors with ADC

MAX6870/MAX6871

ELECTRICAL CHARACTERISTICS (continued)

($V_{IN1} = +6.5V$ to $+13.2V$, $V_{IN2} = +10V$, V_{IN3} to $V_{IN6} = +2.7V$ to $+5.5V$, $AUXIN_ = GPI_ = GND$, $\overline{MARGIN} = \overline{MR} = DBP$, $T_A = -40^\circ C$ to $+85^\circ C$, unless otherwise noted. Typical values are at $T_A = +25^\circ C$.) (Notes 1 and 2)

PARAMETER	SYMBOL	CONDITIONS	MIN	TYP	MAX	UNITS				
\overline{MR} , \overline{MARGIN} , $GPI_$ Input Voltage	V_{IL}				0.8	V				
	V_{IH}		1.4							
\overline{MR} Input Pulse Width	t_{MR}		1			μs				
\overline{MR} Glitch Rejection				100		ns				
\overline{MR} to $PO_$ Delay	t_{DMR}			2		μs				
\overline{MR} to V_{DBP} Pullup Current	I_{MR}	$V_{\overline{MR}} = +1.4V$	5	10	15	μA				
\overline{MARGIN} to V_{DBP} Pullup Current	I_{MARGIN}	$V_{\overline{MARGIN}} = +1.4V$	5	10	15	μA				
$GPI_$ to $PO_$ Delay	$t_{DGPI_}$			200		ns				
$GPI_$ Pulldown Current	$I_{GPI_}$	$V_{GPI_} = +0.8V$	5	10	15	μA				
Watchdog Input Pulse Width	t_{WDI}	$GPI_$ configured as a watchdog input	50			ns				
Watchdog Timeout Period	t_{WD}	Register Contents (Table 28)	000	5.625	6.25	6.875	ms			
			001	22.5	25	27.5				
			010	90	100	110				
			011	360	400	440				
						100	1.44	1.60	1.76	s
						101	5.76	6.40	7.04	
						110	23.04	25.60	28.16	
						111	92.16	102.40	112.64	
Reference Input Voltage Range	V_{REFIN}		1.225	1.25	1.275	V				
Reference Input Resistance	R_{REFIN}	$V_{REFIN} = +1.25V$		500		$k\Omega$				
ADC Range		IN1, LSB = 18.3mV	0		13.2	V				
		IN1, LSB = 9.16mV	0		9.366					
		IN2, LSB = 18.3mV	0		± 15.25					
		IN2, LSB = 9.16mV	0		± 9.366					
		IN3 to IN6, LSB = 7.32mV	0		5.50					
		IN3 to IN6, LSB = 3.66mV	0		3.746					
		AUXIN_, LSB = 1.2mV	0		1.249					
ADC Total Unadjusted Error (Note 5)	TUE	Internal Reference	IN1 to IN6 positive			± 1.0	%FSR			
			IN2 negative			± 1.0				
		External Reference, IN1 to IN6 positive (Note 6)			± 1.0					
ADC Differential Nonlinearity	DNL	(Note 7)		± 1		LSB				
ADC Total Monitoring Cycle Time	t_C	Monitors all 8 inputs		200	266	ms				
AUXIN_ Input Leakage Current	$I_{LAUXIN_}$	$V_{AUXIN_} = 1.25V$	-1		+1	μA				
SERIAL INTERFACE LOGIC (SDA, SCL, A0, A1)										
Logic Input Low Voltage	V_{IL}				0.8	V				
Logic Input High Voltage	V_{IH}		2.0			V				
Input Leakage Current	I_{LKG}		-1		+1	μA				
Output Voltage Low	V_{OL}	$I_{SINK} = 3mA$			0.4	V				
Input/Output Capacitance	$C_{I/O}$			10		pF				

EEPROM-Programmable Hex/Quad Power-Supply Sequencers/Supervisors with ADC

MAX6870/MAX6871

TIMING CHARACTERISTICS

(IN1 = GND, V_{IN2} = +10V, V_{IN3} to V_{IN6} = +2.7V to +5.5V, AUXIN₋ = GPI₋ = GND, $\overline{\text{MARGIN}} = \overline{\text{MR}} = \text{DBP}$, T_A = -40°C to +85°C, unless otherwise noted. Typical values are at T_A = +25°C.) (Notes 1 and 2)

PARAMETER	SYMBOL	CONDITIONS	MIN	TYP	MAX	UNITS
TIMING CHARACTERISTICS (Figure 2)						
Serial Clock Frequency	f _{SCL}				400	kHz
Clock Low Period	t _{LOW}		1.3			μs
Clock High Period	t _{HIGH}		0.6			μs
Bus-Free Time	t _{BUF}		1.3			μs
START Setup Time	t _{SU:STA}		0.6			μs
START Hold Time	t _{HD:STA}		0.6			μs
STOP Setup Time	t _{SU:STO}		0.6			μs
Data-In Setup Time	t _{SU:DAT}		100			ns
Data-In Hold Time	t _{HD:DAT}		0		900	ns
Receive SCL/SDA Minimum Rise Time	t _R	(Note 8)		20 + 0.1 x C _{BUS}		ns
Receive SCL/SDA Maximum Rise Time	t _R	(Note 8)		300		ns
Receive SCL/SDA Minimum Fall Time	t _F	(Note 8)		20 + 0.1 x C _{BUS}		ns
Receive SCL/SDA Maximum Fall Time	t _F	(Note 8)		300		ns
Transmit SDA Fall Time	t _F	C _{BUS} = 400pF	20 + 0.1 x C _{BUS}		300	ns
Pulse Width of Spike Suppressed	t _{SP}	(Note 9)		50		ns
EEPROM Byte Write Cycle Time	t _{WR}	(Note 10)			11	ms

Note 1: Specifications guaranteed for the stated global conditions. The device also meets the parameters specified when 0 < V_{IN1} < +6.5V, and at least one of V_{IN3} through V_{IN6} is between +2.7V and +5.5V, while the remaining V_{IN3} through V_{IN6} are between 0 and +5.5V.

Note 2: Device may be supplied from any one of IN₋, except IN2.

Note 3: The internal supply voltage, measured at ABP, equals the maximum of IN3 to IN6 if V_{IN1} = 0, or equals +5.4V if V_{IN1} > +6.5V. For +4V < V_{IN1} < +6.5V and V_{IN3} through V_{IN6} > +2.7V, the input that powers the device cannot be determined.

Note 4: 100% production tested at T_A = +25°C and T_A = +125°C. Specifications at T_A = -40°C are guaranteed by design.

Note 5: V_{IN₋} > 0.3 x ADC range.

Note 6: Does not include the inaccuracy of the external +1.25V voltage reference.

Note 7: DNL implicitly guaranteed by design in a sigma-delta converter.

Note 8: C_{BUS} = total capacitance of one bus line in pF. Rise and fall times are measured between 0.1 x V_{BUS} and 0.9 x V_{BUS}.

Note 9: Input filters on SDA, SCL, A0, and A1 suppress noise spikes < 50ns.

Note 10: An additional cycle is required when writing to configuration memory for the first time.

EEPROM-Programmable Hex/Quad Power-Supply Sequencers/Supervisors with ADC

Typical Operating Characteristics

(V_{IN1} = +6.5V to +13.2V, V_{IN2} = +10V, $V_{IN3-IN6}$ = +2.7V to +5.5V, $AUXIN_$ = $GPI_$ = GND, $MARGIN_$ = $MR_$ = DBP, T_A = +25°C, unless otherwise noted.)

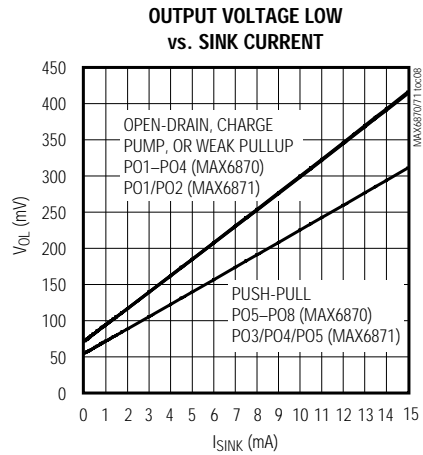
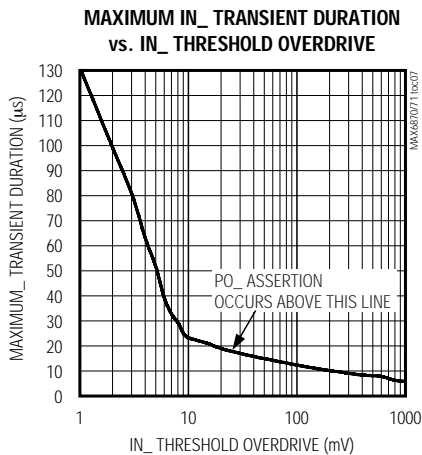
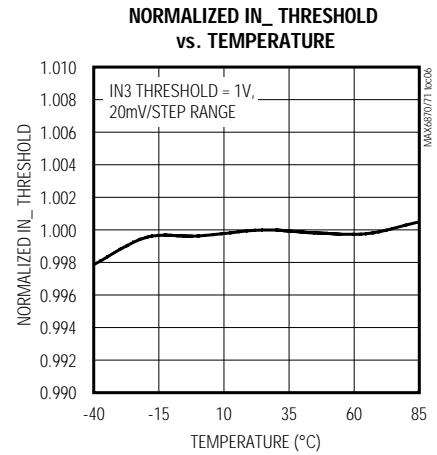
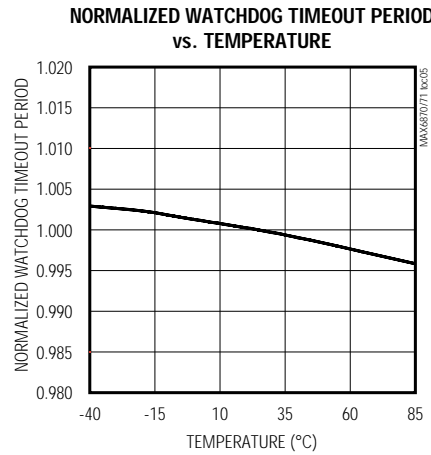
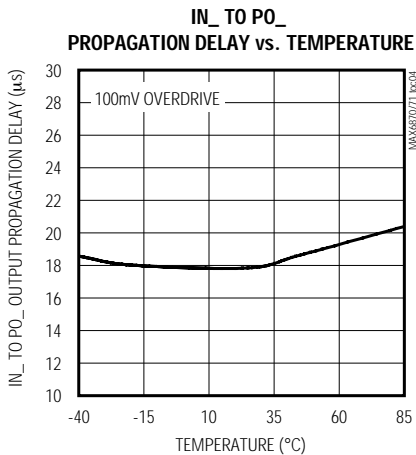
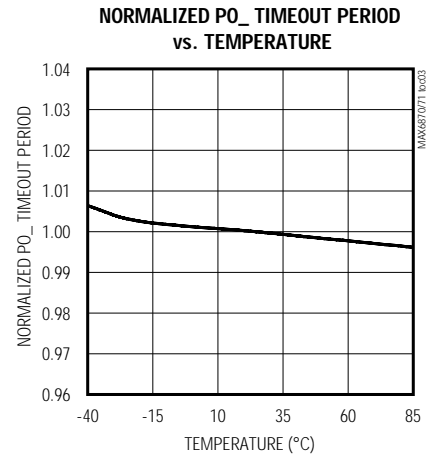
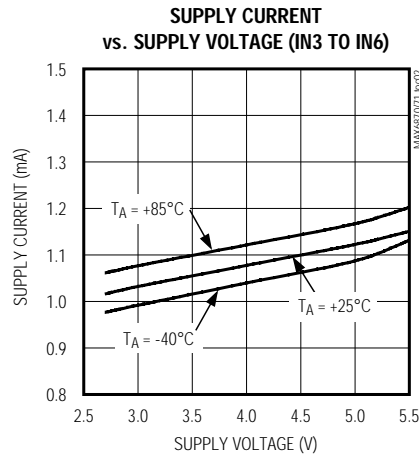
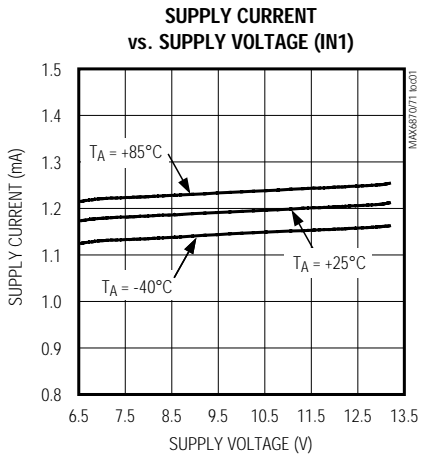

EEPROM-Programmable Hex/Quad Power-Supply Sequencers/Supervisors with ADC

MAX6870/MAX6871

Typical Operating Characteristics (continued)

($V_{IN1} = +6.5V$ to $+13.2V$, $V_{IN2} = +10V$, $V_{IN3-IN6} = +2.7V$ to $+5.5V$, $AUXIN_ = GPI_ = GND$, $\overline{MARGIN} = \overline{MR} = DBP$, $T_A = +25^\circ C$, unless otherwise noted.)

OUTPUT VOLTAGE HIGH vs. SOURCE CURRENT (WEAK PULLUP OUTPUT)

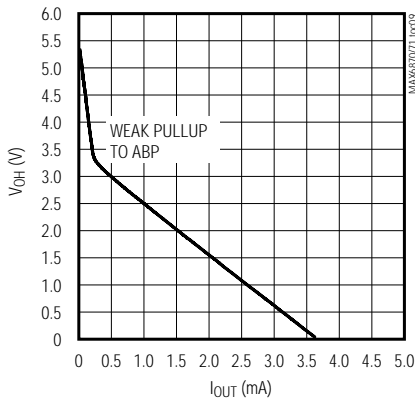

OUTPUT VOLTAGE HIGH vs. SOURCE CURRENT (PUSH-PULL OUTPUT)

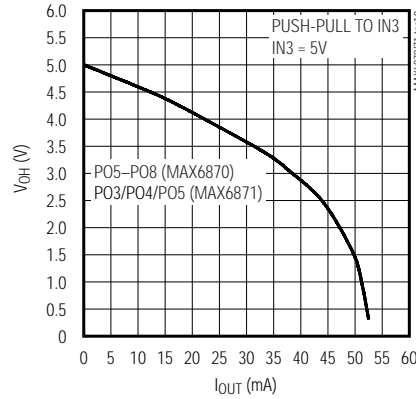

OUTPUT VOLTAGE HIGH vs. SOURCE CURRENT (CHARGE-PUMP OUTPUT)

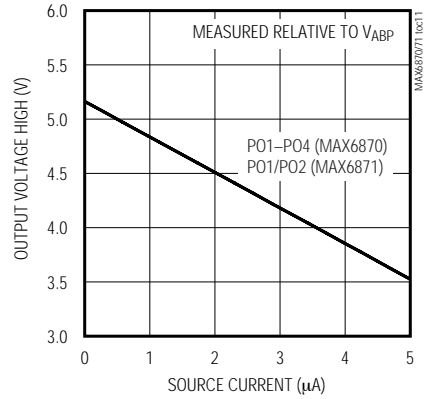

\overline{MR} TO PO_ PROPAGATION DELAY vs. TEMPERATURE

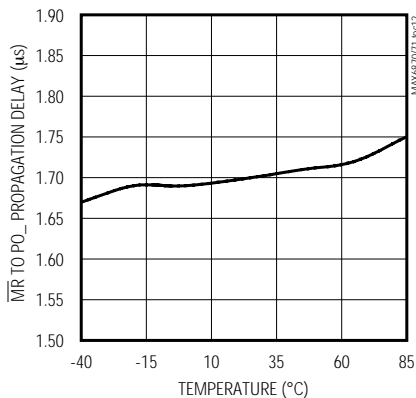

MAXIMUM \overline{MR} TRANSIENT DURATION vs. \overline{MR} THRESHOLD OVERDRIVE

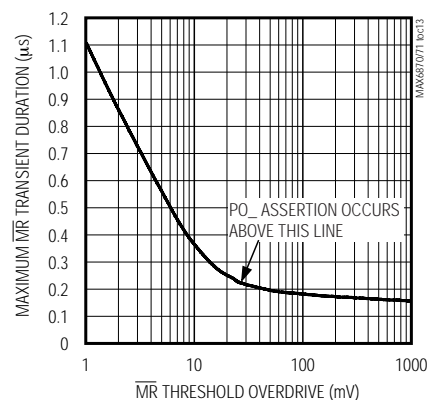

ADC ACCURACY vs. TEMPERATURE

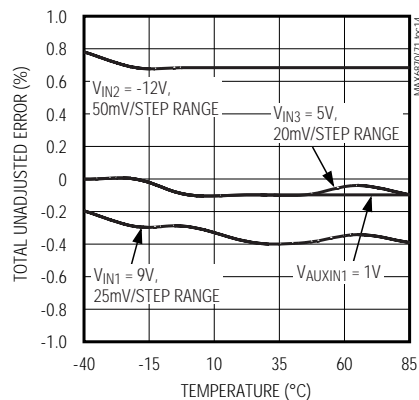

FET (IRF7811W) TURN-ON WITH CHARGE PUMP

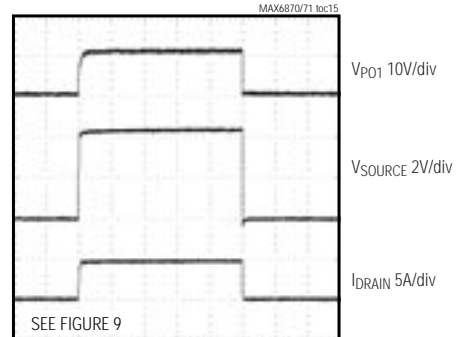

EEPROM-Programmable Hex/Quad Power-Supply Sequencers/Supervisors with ADC

Pin Description

MAX6870/MAX6871

PIN		NAME	FUNCTION
MAX6870	MAX6871		
1	3	PO2	Programmable Output 2. Configurable, active-high, active-low, open-drain, weak pullup, or charge-pump output. PO2 pulls low with a 10µA internal current sink for $+1V < V_{ABP} < V_{UVLO}$. PO2 assumes its programmed conditional output state when ABP exceeds UVLO.
2	5	PO3	Programmable Output 3. Configurable, active-high, active-low, open-drain, weak pullup (MAX6870), push-pull (MAX6871), or charge-pump (MAX6870) output. PO3 pulls low with a 10µA internal current sink for $+1V < V_{ABP} < V_{UVLO}$. PO3 assumes its programmed conditional output state when ABP exceeds UVLO.
3	6	PO4	Programmable Output 4. Configurable, active-high, active-low, open-drain, weak pullup (MAX6870), push-pull (MAX6871), or charge-pump (MAX6870) output. PO4 pulls low with a 10µA internal current sink for $+1V < V_{ABP} < V_{UVLO}$. PO4 assumes its programmed conditional output state when ABP exceeds UVLO.
4	4	GND	Ground
5	7	PO5	Programmable Output 5. Configurable, active-high, active-low, open-drain, weak pullup, or push-pull output. PO5 pulls low with a 10µA internal current sink for $+1V < V_{ABP} < V_{UVLO}$. PO5 assumes its programmed conditional output state when ABP exceeds UVLO.
6	—	PO6	Programmable Output 6. Configurable, active-high, active-low, open-drain, weak pullup, or push-pull output. PO6 pulls low with a 10µA internal current sink for $+1V < V_{ABP} < V_{UVLO}$. PO6 assumes its programmed conditional output state when ABP exceeds UVLO.
7	—	PO7	Programmable Output 7. Configurable, active-high, active-low, open-drain, weak pullup, or push-pull output. PO7 pulls low with a 10µA internal current sink for $+1V < V_{ABP} < V_{UVLO}$. PO7 assumes its programmed conditional output state when ABP exceeds UVLO.
8	—	PO8	Programmable Output 8. Configurable, active-high, active-low, open-drain, weak pullup, or push-pull output. PO8 pulls low with a 10µA internal current sink for $+1V < V_{ABP} < V_{UVLO}$. PO8 assumes its programmed conditional output state when ABP exceeds UVLO.
9, 10	1, 8, 9, 10, 25, 26, 32	N.C.	No Connection. Not internally connected.
11	11	$\overline{\text{MARGIN}}$	Margin Input. Configure $\overline{\text{MARGIN}}$ to either assert PO_ into a programmed state or to hold PO_ in its existing state when driving $\overline{\text{MARGIN}}$ low. See Table 8. Leave $\overline{\text{MARGIN}}$ unconnected or connect to DBP if unused. $\overline{\text{MARGIN}}$ overrides $\overline{\text{MR}}$ if both assert at the same time. $\overline{\text{MARGIN}}$ is internally pulled up to DBP through a 10µA current source.
12	12	$\overline{\text{MR}}$	Manual Reset Input. Configure $\overline{\text{MR}}$ to either assert PO_ into a programmed state or to have no effect on PO_ when driving $\overline{\text{MR}}$ low. See Table 7. Leave $\overline{\text{MR}}$ unconnected or connect to DBP if unused. $\overline{\text{MR}}$ is internally pulled up to DBP through a 10µA current source.
13	13	SDA	Serial Data Input/Output (Open-Drain). SDA requires an external pullup resistor.
14	14	SCL	Serial Clock Input. SCL requires an external pullup resistor.
15	15	A0	Address Input 0. Address inputs allow up to four MAX6870/MAX6871 connections on one common bus. Connect A0 to GND or to the serial interface power supply.
16	16	A1	Address Input 1. Address inputs allow up to four MAX6870/MAX6871 connections on one common bus. Connect A1 to GND or to the serial interface power supply.

EEPROM-Programmable Hex/Quad Power-Supply Sequencers/Supervisors with ADC

Pin Description (continued)

MAX6870/MAX6871

PIN		NAME	FUNCTION
MAX6870	MAX6871		
17	17	GPI4	General-Purpose Logic Input 4. An internal 10µA current source pulls GPI4 to GND. Configure GPI4 to control watchdog timer functions or the programmable outputs.
18	18	GPI3	General-Purpose Logic Input 3. An internal 10µA current source pulls GPI3 to GND. Configure GPI3 to control watchdog timer functions or the programmable outputs.
19	19	GPI2	General-Purpose Logic Input 2. An internal 10µA current source pulls GPI2 to GND. Configure GPI2 to control watchdog timer functions or the programmable outputs.
20	20	GPI1	General-Purpose Logic Input 1. An internal 10µA current source pulls GPI1 to GND. Configure GPI1 to control watchdog timer functions or the programmable outputs.
21	21	ABP	Internal Power-Supply Output. Bypass ABP to GND with a 1µF ceramic capacitor. ABP powers the internal circuitry of the MAX6870/MAX6871. ABP supplies the input voltage to the internal charge pumps when the programmable outputs are configured as charge-pump outputs. Do not use ABP to supply power to external circuitry.
22	22	DBP	Internal Digital Power-Supply Output. Bypass DBP to GND with a 1µF ceramic capacitor. DBP supplies power to the EEPROM memory and the internal logic circuitry. Do not use DBP to supply power to external circuitry.
23	23	AUXIN2	Auxiliary Input 2. A 10-bit ADC monitors the input voltage at AUXIN2. The high-impedance AUXIN2 input accepts input voltages up to V_{REFIN} . AUXIN2 does not influence EEPROM-configurable power-supply sequencing or reset detection functions.
24	24	AUXIN1	Auxiliary Input 1. A 10-bit ADC monitors the input voltage at AUXIN1. The high-impedance AUXIN1 input accepts input voltages up to V_{REFIN} . AUXIN1 does not influence EEPROM-configurable power-supply sequencing or reset detection functions.
25	—	IN6	Voltage Input 6. Configure IN6 to detect voltage thresholds between +1V and +5.5V in 20mV increments, or +0.5V to +3.05V in 10mV increments. For improved noise immunity, bypass IN6 to GND with a 0.1µF capacitor installed as close to the device as possible.
26	—	IN5	Voltage Input 5. Configure IN5 to detect voltage thresholds between +1V and +5.5V in 20mV increments, or +0.5V to +3.05V in 10mV increments. For improved noise immunity, bypass IN5 to GND with a 0.1µF capacitor installed as close to the device as possible.
27	27	IN4	Voltage Input 4. Configure IN4 to detect voltage thresholds between +1V and +5.5V in 20mV increments, or +0.5V to +3.05V in 10mV increments. For improved noise immunity, bypass IN4 to GND with a 0.1µF capacitor installed as close to the device as possible.
28	28	IN3	Voltage Input 3. Configure IN3 to detect voltage thresholds between +1V and +5.5V in 20mV increments, or +0.5V to +3.05V in 10mV increments. For improved noise immunity, bypass IN3 to GND with a 0.1µF capacitor installed as close to the device as possible.
29	29	IN2	Bipolar Voltage Input 2. Configure IN2 to detect negative voltage thresholds from -2.5V to -15.25V in 50mV increments or -1.25V to -7.625V in 25mV increments. Alternatively, configure IN2 to detect positive voltage thresholds from +2.5V to +15.25V in 50mV increments or +1.25V to +7.625V in 25mV increments. For improved noise immunity, bypass IN2 to GND with a 0.1µF capacitor installed as close to the device as possible.

EEPROM-Programmable Hex/Quad Power-Supply Sequencers/Supervisors with ADC

Pin Description (continued)

PIN		NAME	FUNCTION
MAX6870	MAX6871		
30	30	IN1	High Voltage Input 1. Configure IN1 to detect voltage thresholds from +2.5V to +13.2V in 50mV increments or +1.25V to +7.625V in 25mV increments. For improved noise immunity, bypass IN1 to GND with a 0.1µF capacitor installed as close to the device as possible.
31	31	REFIN	Reference Voltage Input. Configure the MAX6870/MAX6871 to use either an internal reference or external reference (see Table 9). When configured for an internal reference, leave REFIN unconnected. When configured for an external reference, connect a +1.225V to +1.275V reference to REFIN.
32	2	PO1	Programmable Output 1. Configurable active-high, active-low, open-drain, weak pullup, or charge-pump output. PO1 pulls low with a weak 10µA internal current sink for +1V < V _{ABP} < V _{UVLO} . PO1 assumes its programmed conditional output state when ABP exceeds UVLO.
—	—	EP	Exposed Paddle. Exposed paddle is internally connected to GND.

Detailed Description

The MAX6870/MAX6871 EEPROM-configurable, multi-voltage supply sequencers/supervisors monitor several voltage-detector inputs, two auxiliary inputs and four general-purpose logic inputs, and feature programmable outputs for highly-configurable, power-supply sequencing applications. The MAX6870 features six voltage-detector inputs and eight programmable outputs, while the MAX6871 features four voltage-detector inputs and five programmable outputs. Manual reset and margin disable inputs simplify board-level testing during the manufacturing process. The MAX6870/MAX6871 feature an accurate internal 1.25V reference. For greater accuracy, connect an external +1.25V reference to REFIN.

All voltage detectors provide two configurable thresholds for undervoltage/overvoltage or dual undervoltage detection. One high-voltage input (IN1) provides detector threshold voltages from +1.25V to +7.625V in 25mV increments or +2.5V to +13.2V in 50mV increments. A bipolar input (IN2) provides detector threshold voltages from ±1.25V to ±7.625V in 25mV increments, or ±2.5V to ±15.25V in 50mV increments. Positive inputs (IN3–IN6) provide detector threshold voltages from +0.5V to +3.05V in 10mV increments, or +1.0V to +5.5V in 20mV increments.

An internal 10-bit ADC monitors the voltage-detector inputs and two auxiliary inputs through a multiplexer that automatically sequences through all inputs every 200ms. The host controller communicates with the MAX6870/MAX6871s' internal 4kb user EEPROM, configuration EEPROM, configuration registers, ADC registers, and fault registers through an SMBus/I²C-compatible serial interface (see Figure 1).

Programmable output options include active-high, active-low, open-drain, weak pullup, push-pull, and charge pump. Select the charge-pump output feature to drive n-channel FETs for power-supply sequencing (see the *Applications Information* section). The outputs swing between 0 and (V_{ABP} + 5V) when configured for charge-pump operation.

Program each output to assert on any voltage-detector input, general-purpose logic input, watchdog timer, manual reset, or other output stages. Programmable timing-delay blocks configure each output to wait between 25µs and 1600ms before deasserting. A fault register logs the conditions that caused each output to assert (undervoltage, overvoltage, manual reset, etc.).

The MAX6870/MAX6871 feature two watchdog timers, adding flexibility. Program each watchdog timer to assert one or more programmable outputs. Program each

EEPROM-Programmable Hex/Quad Power-Supply Sequencers/Supervisors with ADC

MAX6870/MAX6871

watchdog timer to clear on a combination of one GPI_ input and one programmable output, one of the GPI_ inputs only, or one of the programmable outputs only. The initial and normal watchdog timeout periods are independently programmable from 6.25ms to 102.4s.

A virtual diode-ORing scheme selects the input that powers the MAX6870/MAX6871. The MAX6870/MAX6871

derive power from IN1 if $V_{IN1} > +6.5V$ or from the highest voltage on IN3–IN6 if $V_{IN1} < +2.7V$. The power source cannot be determined if $+4V < V_{IN1} < +6.5V$ and one of V_{IN3} through $V_{IN6} > +2.7V$. The programmable outputs maintain the correct programmed logic state for $V_{ABP} > V_{UVLO}$. One of IN3 through IN6 must be greater than +2.7V or IN1 must be greater than +4V for device operation.

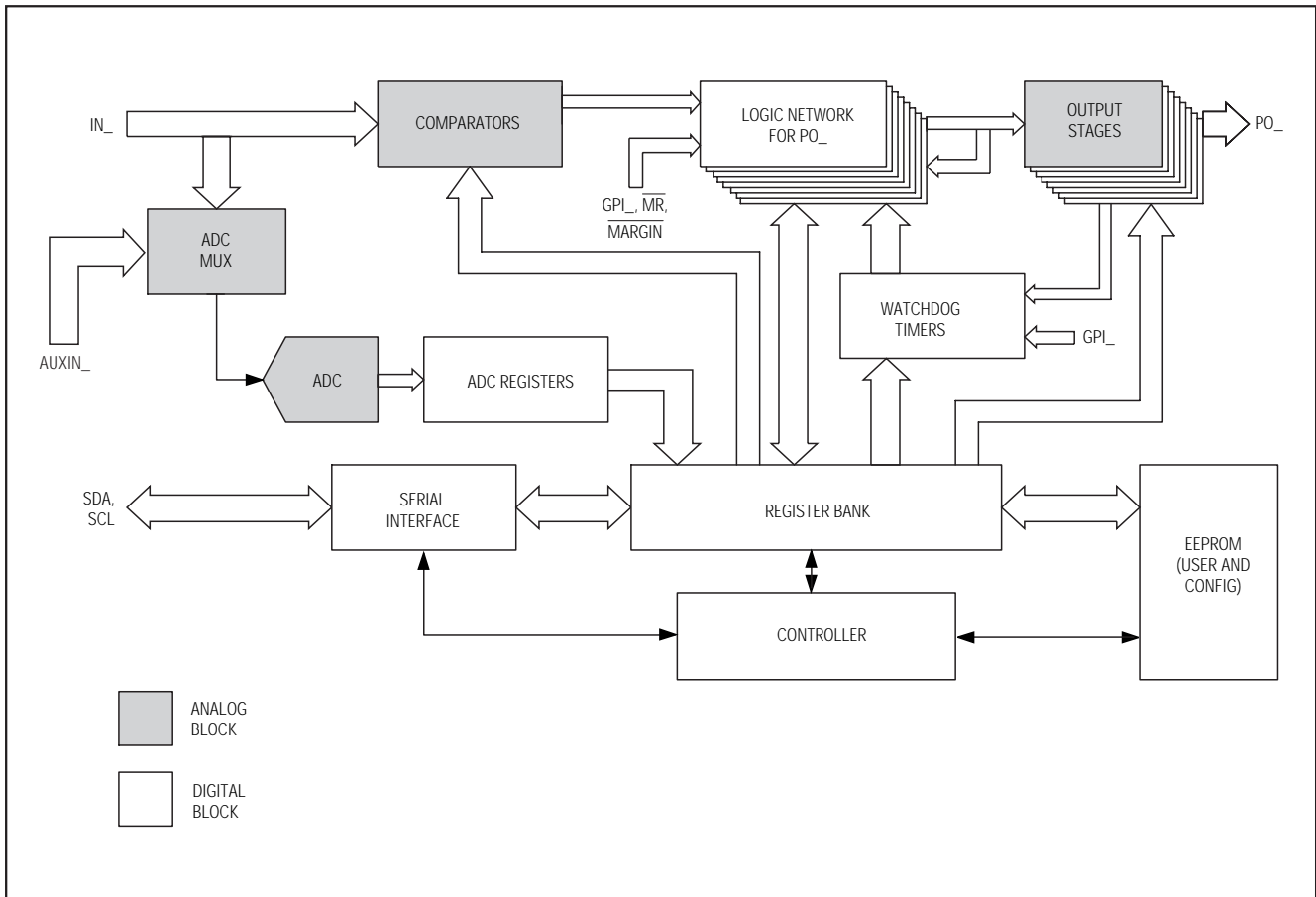
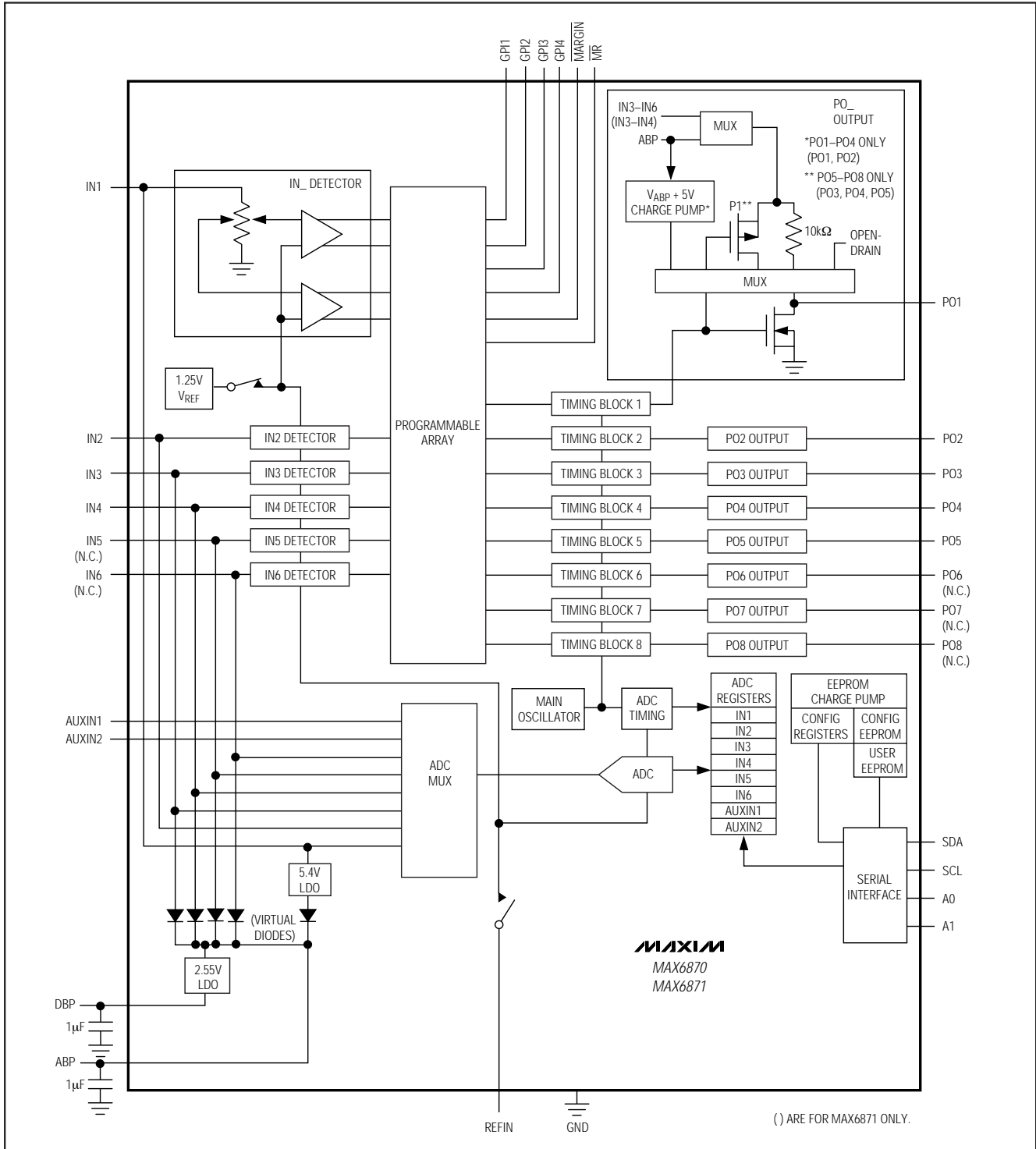

Figure 1. Top Level Block Diagram

EEPROM-Programmable Hex/Quad Power-Supply Sequencers/Supervisors with ADC

Functional Diagram

MAX6870/MAX6871



EEPROM-Programmable Hex/Quad Power-Supply Sequencers/Supervisors with ADC

MAX6870/MAX6871

Powering the MAX6870/MAX6871

The MAX6870/MAX6871 derive power from the positive voltage-detector inputs: IN1, or IN3–IN6. A virtual diode-ORing scheme selects the positive input that supplies power to the device (see the *Functional Diagram*). IN1 must be at least +4V or one of IN3–IN6 (MAX6870)/IN3/IN4 (MAX6871) must be at least +2.7V to ensure device operation. An internal LDO regulates IN1 down to +5.4V.

The highest input voltage on IN3–IN6 (MAX6870)/IN3/IN4 (MAX6871) supplies power to the device, unless $V_{IN1} \geq +6.5V$, in which case IN1 supplies power to the device. For $+4V < V_{IN1} < +6.5V$ and one of V_{IN3} through $V_{IN6} > +2.7V$, the input power source cannot be determined due to the dropout voltage of the LDO. Internal hysteresis ensures that the supply input that initially powered the device continues to power the device when multiple input voltages are within 50mV of each other.

ABP powers the analog circuitry; bypass ABP to GND with a 1μF ceramic capacitor installed as close to the device as possible. The internal supply voltage, measured at ABP, equals the maximum of IN3–IN6 (MAX6870)/IN3/IN4 (MAX6871) if $V_{IN1} = 0$, or equals +5.4V when $V_{IN1} > +6.5V$. Do not use ABP to provide power to external circuitry.

The MAX6870/MAX6871 also generate a digital supply voltage (DBP) for the internal logic circuitry and the EEPROM; bypass DBP to GND with a 1μF ceramic capacitor installed as close to the device as possible. The nominal DBP output voltage is +2.55V. Do not use DBP to provide power to external circuitry.

ADC

The MAX6870/MAX6871 feature an internal 10-bit ADC that monitors the voltage-detector inputs and auxiliary inputs through an internal multiplexer that sequences through all input voltages in 200ms. Registers 50h to 5Fh store the ADC data. Read the ADC data from the MAX6870/MAX6871 with the serial interface. The ADC strictly monitors input voltages and has no effect on power-supply sequencing, reset detection, or the programmable outputs.

Inputs

The MAX6870/MAX6871 contain multiple logic and voltage-detector inputs. Each voltage-detector input is simultaneously monitored for primary and secondary thresholds. The primary threshold must be an undervoltage threshold. The secondary threshold may be an undervoltage or overvoltage threshold. Table 1 summarizes these various inputs.

Table 1. Programmable Features

FEATURE	DESCRIPTION
High Voltage Input (IN1)	<ul style="list-style-type: none"> • Primary undervoltage threshold • Secondary overvoltage or undervoltage threshold • +2.5V to +13.2V threshold in 50mV increments • +1.25V to +7.625V threshold in 25mV increments
Bipolar Voltage Input (IN2)	<ul style="list-style-type: none"> • Primary undervoltage threshold • Secondary overvoltage or undervoltage threshold • ±2.5V to ±15.25V threshold in 50mV increments • ±1.25V to ±7.625V threshold in 25mV increments
Positive Voltage Input IN3–IN6 (MAX6870) IN3, IN4 (MAX6871)	<ul style="list-style-type: none"> • Primary undervoltage threshold • Secondary overvoltage or undervoltage threshold • +1V to +5.5V threshold in 20mV increments • +0.5V to +3.05V threshold in 10mV increments
Programmable Outputs PO1–PO4 (MAX6870), PO1, PO2 (MAX6871)	<ul style="list-style-type: none"> • Active high or active low • Open-drain, weak pullup, or charge-pump output • Weak pullup to IN3–IN6 (IN3 or IN4 for MAX6871) or ABP • Dependent on \overline{MR}, \overline{MARGIN}, $IN_{_}$, GPI1–GPI4, WDI1 and WDI2, and/or $PO_{_}$ • Programmable timeout periods of 25μs, 1.5625ms, 6.25ms, 25ms, 50ms, 200ms, 400ms, or 1.6s
Programmable Outputs PO5–PO8 (MAX6870), PO3, PO4, PO5 (MAX6871)	<ul style="list-style-type: none"> • Active high or active low • Open-drain, weak pullup, or push-pull output • Weak pullup to IN3–IN6 (IN3 or IN4 for MAX6871) or ABP • Push-pull to IN3–IN6 (IN3 or IN4 for MAX6871) • Dependent on \overline{MR}, \overline{MARGIN}, $IN_{_}$, GPI1–GPI4, WDI1 and WDI2, and/or $IN_{_}$ • Programmable timeout periods of 25μs, 1.5625ms, 6.25ms, 25ms, 50ms, 200ms, 400ms, or 1.6s

EEPROM-Programmable Hex/Quad Power-Supply Sequencers/Supervisors with ADC

Table 1. Programmable Features (continued)

FEATURE	DESCRIPTION
General-Purpose Logic Inputs (GPI1–GPI4)	<ul style="list-style-type: none"> Active high or active low logic levels Configure GPI_ as inputs to watchdog timers or programmable output stages
Watchdog Timers	<ul style="list-style-type: none"> Clear dependent on any combination of one GPI_ input and one programmable output, a GPI_ input only, or a programmable output only Initial watchdog timeout period of 6.25ms, 25ms, 100ms, 400ms, 1.6s, 6.4s, 25.6s, or 102.4s Normal watchdog timeout period of 6.25ms, 25ms, 100ms, 400ms, 1.6s, 6.4s, 25.6s, or 102.4s Watchdog enable/disable Initial watchdog timeout period enable/disable
Auxiliary Inputs (AUXIN1, AUXIN2)	<ul style="list-style-type: none"> Monitored by the internal 10-bit ADC
Manual Reset Input (MR)	<ul style="list-style-type: none"> Forces PO_ into the active output state when $\overline{MR} = \text{GND}$ PO_ deassert after \overline{MR} releases high and the PO_ timeout period expires PO_ cannot be a function of \overline{MR} only
Margining Input (MARGIN)	<ul style="list-style-type: none"> Holds PO_ in existing state or asserts PO_ to a programmed output state, independent of changes in monitored inputs or watchdog timers, when $\overline{MARGIN} = \text{GND}$ Overrides \overline{MR} when both assert at the same time
Reference Input (REFIN)	<ul style="list-style-type: none"> Internal +1.25V reference voltage Goes high-impedance when internal reference selected External reference voltage input from +1.225V to +1.275V Sets ADC voltage range
10-Bit ADC*	<ul style="list-style-type: none"> Monitors IN_, AUXIN1, and AUXIN2 Completes conversion of all eight inputs in 200ms Reference voltage sets ADC range Read ADC data from SMBus/I²C interface
Write Disable	<ul style="list-style-type: none"> Locks user EEPROM based on PO_
Configuration Lock	<ul style="list-style-type: none"> Locks configuration EEPROM

*ADC does not control programmable outputs.

Set the primary and secondary threshold voltages for each voltage-detector input with registers 00h–0Bh. Each primary threshold voltage must be an undervoltage threshold. Configure each secondary threshold voltage as an undervoltage or overvoltage threshold (see register 0Ch). Set the threshold range for each voltage detector with register 0Dh.

High Voltage Input (IN1)

IN1 offers threshold voltages of +2.5V to +13.2V in 50mV increments, or +1.25V to +7.625V in 25mV increments. Use the following equations to set the threshold voltages for IN1:

$$x = \frac{V_{TH} - 2.5V}{0.05V} \text{ for } +2.5V \text{ to } +13.2V \text{ range}$$

$$x = \frac{V_{TH} - 1.25V}{0.025V} \text{ for } +1.25V \text{ to } +7.625V \text{ range}$$

where V_{TH} is the desired threshold voltage and x is the decimal code for the desired threshold (Table 2). For the +2.5V to +13.2V range, x must equal 214 or less, otherwise the threshold exceeds the maximum operating voltage of IN1.

Bipolar Voltage Input (IN2)

IN2 offers negative thresholds from -2.5V to -15.25V in 50mV increments, or from -1.25V to -7.625V in 25mV increments. Alternatively, IN2 offers positive thresholds from +2.5V to +15.25V in 50mV increments, or +1.25V to +7.625V in 25mV increments. Use the following equations to set the threshold voltages for IN2:

EEPROM-Programmable Hex/Quad Power-Supply Sequencers/Supervisors with ADC

MAX6870/MAX6871

$$x = \frac{-(V_{TH} - 2.5V)}{0.05V} \text{ for } -2.5V \text{ to } -15.25V \text{ range}$$

$$x = \frac{-(V_{TH} - 1.25V)}{0.025V} \text{ for } -1.25V \text{ to } -7.625V \text{ range}$$

$$x = \frac{V_{TH} - 2.5V}{0.05V} \text{ for } +2.5V \text{ to } +15.25V \text{ range}$$

$$x = \frac{V_{TH} - 1.25V}{0.025V} \text{ for } +1.25V \text{ to } +7.625V \text{ range}$$

where V_{TH} is the desired threshold voltage and x is the decimal code for the desired threshold (Table 3).

IN3-IN6

IN3-IN6 offer positive voltage detectors monitor voltages from +1V to +5.5V in 20mV increments, or +0.5V to +3.05V in 10mV increments. Use the following equations to set the threshold voltages for IN_n:

$$x = \frac{V_{TH} - 1V}{0.02V} \text{ for } +1V \text{ to } +5.5V \text{ range}$$

$$x = \frac{V_{TH} - 0.5V}{0.01V} \text{ for } +0.5V \text{ to } +3.05V \text{ range}$$

where V_{TH} is the desired threshold voltage and x is the decimal code for the desired threshold (Table 4). For the +1V to +5.5V range, x must equal 225 or less, otherwise the threshold exceeds the maximum operating voltage of IN3-IN6.

Table 2. IN1 Threshold Settings

REGISTER ADDRESS	EEPROM MEMORY ADDRESS	BIT RANGE	DESCRIPTION
00h	8000h	[7:0]	IN1 primary undervoltage detector threshold (V1A) (see equations in the <i>High Voltage Input (IN1)</i> section).
06h	8006h	[7:0]	IN1 secondary undervoltage/overvoltage detector threshold (V1B) (see equations in the <i>High Voltage Input (IN1)</i> section).
0Ch	800Ch	[0]	IN1 secondary overvoltage/undervoltage selection. 0 = overvoltage threshold. 1 = undervoltage threshold.
0Dh	800Dh	[0]	IN1 range selection. 0 = 2.5V to 13.2V range in 50mV increments. 1 = 1.25V to 7.625V range in 25mV increments.

Table 3. IN2 Threshold Settings

REGISTER ADDRESS	EEPROM MEMORY ADDRESS	BIT RANGE	DESCRIPTION
01h	8001h	[7:0]	IN2 primary undervoltage detector threshold (V2A) (see equations in the <i>Bipolar Voltage Input (IN2)</i> section).
07h	8007h	[7:0]	IN2 secondary undervoltage/overvoltage detector threshold (V2B) (see equations in the <i>Bipolar Voltage Input (IN2)</i> section).
0Ch	800Ch	[1]	IN2 secondary overvoltage/undervoltage selection. 0 = overvoltage threshold. 1 = undervoltage threshold.
0Dh	800Dh	[7:6]	IN2 range selection. 00 = -2.5V to -15.25V range in 50mV increments. 01 = -1.25V to -7.625V range in 25mV increments. 10 = +2.5V to +15.25V range in 50mV increments. 11 = +1.25V to +7.625V range in 25mV increments.

EEPROM-Programmable Hex/Quad Power-Supply Sequencers/Supervisors with ADC

MAX6870/MAX6871

Table 4. IN3–IN6 Threshold Settings

REGISTER ADDRESS	EEPROM MEMORY ADDRESS	BIT RANGE	DESCRIPTION
02h	8002h	[7:0]	IN3 primary undervoltage detector threshold (V3A) (see equations in the <i>IN3–IN6</i> section).
03h	8003h	[7:0]	IN4 primary undervoltage detector threshold (V4A) (see equations in the <i>IN3–IN6</i> section).
04h	8004h	[7:0]	IN5 (MAX6870 only) primary undervoltage detector threshold (V5A) (see equations in the <i>IN3–IN6</i> section).
05h	8005h	[7:0]	IN6 (MAX6870 only) primary undervoltage detector threshold (V6A) (see equations in the <i>IN3–IN6</i> section).
08h	8008h	[7:0]	IN3 secondary undervoltage/overvoltage detector threshold (V3B) (see equations in the <i>IN3–IN6</i> section).
09h	8009h	[7:0]	IN4 secondary undervoltage/overvoltage detector threshold (V4B) (see equations in the <i>IN3–IN6</i> section).
0Ah	800Ah	[7:0]	IN5 (MAX6870 only) secondary undervoltage/overvoltage detector threshold (V5B) (see equations in the <i>IN3–IN6</i> section).
0Bh	800Bh	[7:0]	IN6 (MAX6870 only) secondary undervoltage/overvoltage detector threshold (V6B) (see equations in the <i>IN3–IN6</i> section).
0Ch	800Ch	[2]	IN3 secondary overvoltage/undervoltage selection. 0 = overvoltage threshold. 1 = undervoltage threshold.
		[3]	IN4 secondary overvoltage/undervoltage selection. 0 = overvoltage threshold. 1 = undervoltage threshold.
		[4]	IN5 (MAX6870 only) secondary overvoltage/undervoltage selection. 0 = overvoltage threshold. 1 = undervoltage threshold.
		[5]	IN6 (MAX6870 only) secondary overvoltage/undervoltage selection. 0 = overvoltage threshold. 1 = undervoltage threshold.
		[7:6]	Not used.
0Dh	800Dh	[1]	IN3 range selection. 0 = +1V to +5.5V range in 20mV increments. 1 = +0.5V to +3.05V range in 10mV increments.
		[2]	IN4 range selection. 0 = +1V to +5.5V range in 20mV increments. 1 = +0.5V to +3.05V range in 10mV increments.
		[3]	IN5 (MAX6870 only) range selection. 0 = +1V to +5.5V range in 20mV increments. 1 = +0.5V to +3.05V range in 10mV increments.
		[4]	IN6 (MAX6870 only) range selection. 0 = +1V to +5.5V range in 20mV increments. 1 = +0.5V to +3.05V range in 10mV increments.
		[5]	Not used.

EEPROM-Programmable Hex/Quad Power-Supply Sequencers/Supervisors with ADC

MAX6870/MAX6871

AUXIN1 and AUXIN2

The AUXIN1 and AUXIN2 high-impedance analog inputs are intended to monitor two additional system voltages not required for power-supply sequencing or reset purposes. The internal 10-bit ADC monitors AUXIN1 and AUXIN2 and stores the data in the ADC registers (Table

5). AUXIN1 and AUXIN2 do not assert any of the programmable outputs. The AUXIN1 and AUXIN2 inputs accept power-supply voltages or other system voltages scaled to the +1.25V ADC input voltage range.

GPI1–GPI4

The GPI1–GPI4 programmable logic inputs control power-supply sequencing (programmable outputs), reset/interrupt signaling, and watchdog functions (see the *Configuring the Watchdog Timers (Registers 3Ch–3Fh)* section). Configure GPI1–GPI4 for active-low or active-high logic (Table 6). GPI1–GPI4 internally pull down to GND through a 10µA current sink.

\overline{MR}

The manual reset (\overline{MR}) input initiates a reset condition. Register 40h determines the programmable outputs that assert while \overline{MR} is low (Table 7). All affected programmable outputs remain asserted (see the *Programmable Outputs* section) for their PO_ timeout periods after \overline{MR} releases high. An internal 10µA current source pulls \overline{MR} to DBP. Leave \overline{MR} unconnected or connect to DBP if unused. A programmable output cannot depend solely on \overline{MR} .

Table 5. ADC Registers for AUXIN1 and AUXIN2 (Read Only)

REGISTER ADDRESS	BIT RANGE	DESCRIPTION
5Ch	[7:0]	AUXIN1 measured value, 8 MSBs.
5Dh	[1:0]	AUXIN1 measured value, 2 LSBs.
	[7:2]	Not used.
5Eh	[7:0]	AUXIN2 measured value, 8 MSBs.
5Fh	[1:0]	AUXIN2 measured value, 2 LSBs.
	[7:2]	Not used.

Table 6. GPI1–GPI4 Active Logic States

REGISTER ADDRESS	BIT RANGE	DESCRIPTION
3Bh	[0]	GPI1. 0 = active low. 1 = active high.
	[1]	GPI2. 0 = active low. 1 = active high.
	[2]	GPI3. 0 = active low. 1 = active high.
	[3]	GPI4. 0 = active low. 1 = active high.

Table 7. Programmable Output Behavior and \overline{MR}

REGISTER ADDRESS	EEPROM MEMORY ADDRESS	BIT RANGE	DESCRIPTION
40h	8040h	[0]	PO1 (MAX6870 only). 0 = PO1 independent of \overline{MR} . 1 = PO1 asserts when \overline{MR} = low.
		[1]	PO2 (MAX6870 only). 0 = PO2 independent of \overline{MR} . 1 = PO2 asserts when \overline{MR} = low.
		[2]	PO3 (MAX6870)/PO1 (MAX6871). 0 = PO3/PO1 independent of \overline{MR} . 1 = PO3/PO1 asserts when \overline{MR} = low.
		[3]	PO4 (MAX6870)/PO2 (MAX6871). 0 = PO4/PO2 independent of \overline{MR} . 1 = PO4/PO2 asserts when \overline{MR} = low.
		[4]	PO5 (MAX6870)/PO3 (MAX6871). 0 = PO5/PO3 independent of \overline{MR} . 1 = PO5/PO3 asserts when \overline{MR} = low.
		[5]	PO6 (MAX6870)/PO4 (MAX6871). 0 = PO6/PO4 independent of \overline{MR} . 1 = PO6/PO4 asserts when \overline{MR} = low.
		[6]	PO7 (MAX6870)/PO5 (MAX6871). 0 = PO7/PO5 independent of \overline{MR} . 1 = PO7/PO5 asserts when \overline{MR} = low.
		[7]	PO8 (MAX6870 only). 0 = PO8 independent of \overline{MR} . 1 = PO8 asserts when \overline{MR} = low.

EEPROM-Programmable Hex/Quad Power-Supply Sequencers/Supervisors with ADC

MARGIN

MARGIN allows system-level testing while power supplies exceed the normal ranges. Registers 41h and 42h determine whether the programmable outputs assert to a predetermined state or hold the last state as MARGIN is driven low (Table 8). Drive MARGIN low to set the programmable outputs in a known state while system-

level testing occurs. Leave MARGIN unconnected or connect to DBP if unused. An internal 10 μ A current source pulls MARGIN to DBP. The internal ADC continually monitors IN₋ while MARGIN is low. The state of each programmable output does not change while MARGIN = GND. MARGIN overrides MR if both assert at the same time.

Table 8. Programmable Output Behavior and MARGIN

REGISTER ADDRESS	EEPROM MEMORY ADDRESS	BIT RANGE	AFFECTED OUTPUT	DESCRIPTION
41h	8041h	[0]	PO1 (MAX6870 only)	0 = output held in existing state. 1 = output asserts high or low (see 42h[0]).
		[1]	PO2 (MAX6870 only)	0 = output held in existing state. 1 = output asserts high or low (see 42h[1]).
		[2]	PO3 (MAX6870) PO1 (MAX6871)	0 = output held in existing state. 1 = output asserts high or low (see 42h[2]).
		[3]	PO4 (MAX6870) PO2 (MAX6871)	0 = output held in existing state. 1 = output asserts high or low (see 42h[3]).
		[4]	PO5 (MAX6870) PO3 (MAX6871)	0 = output held in existing state. 1 = output asserts high or low (see 42h[4]).
		[5]	PO6 (MAX6870) PO4 (MAX6871)	0 = output held in existing state. 1 = output asserts high or low (see 42h[5]).
		[6]	PO7 (MAX6870) PO5 (MAX6871)	0 = output held in existing state. 1 = output asserts high or low (see 42h[6]).
		[7]	PO8 (MAX6870 only)	0 = output held in existing state. 1 = output asserts high or low (see 42h[7]).
42h	8042h	[0]	PO1 (MAX6870 only)	0 = output asserts low if 41h[0] = 1. 1 = output asserts high if 41h[0] = 1.
		[1]	PO2 (MAX6870 only)	0 = output asserts low if 41h[1] = 1. 1 = output asserts high if 41h[1] = 1.
		[2]	PO3 (MAX6870) PO1 (MAX6871)	0 = output asserts low if 41h[2] = 1. 1 = output asserts high if 41h[2] = 1.
		[3]	PO4 (MAX6870) PO2 (MAX6871)	0 = output asserts low if 41h[3] = 1. 1 = output asserts high if 41h[3] = 1.
		[4]	PO5 (MAX6870) PO3 (MAX6871)	0 = output asserts low if 41h[4] = 1. 1 = output asserts high if 41h[4] = 1.
		[5]	PO6 (MAX6870) PO4 (MAX6871)	0 = output asserts low if 41h[5] = 1. 1 = output asserts high if 41h[5] = 1.
		[6]	PO7 (MAX6870) PO5 (MAX6871)	0 = output asserts low if 41h[6] = 1. 1 = output asserts high if 41h[6] = 1.
		[7]	PO8 (MAX6870 only)	0 = output asserts low if 41h[7] = 1. 1 = output asserts high if 41h[7] = 1.

EEPROM-Programmable Hex/Quad Power-Supply Sequencers/Supervisors with ADC

MAX6870/MAX6871

REFIN

The MAX6870/MAX6871 feature an internal +1.25V voltage reference. The voltage reference sets the threshold of the voltage detectors and provides a reference voltage for the internal ADC. Program register 44h to use the internal reference or an external reference (Table 9). Leave REFIN unconnected when using the internal reference. REFIN accepts an external reference in the +1.225V to +1.275V range.

Table 9. Reference Register

REGISTER ADDRESS	EEPROM MEMORY ADDRESS	BIT RANGE	DESCRIPTION
44h	8044h	[0]	0 = internal reference. 1 = external reference.
		[7:1]	Not used.

Programmable Outputs

The MAX6870 features eight programmable outputs, while the MAX6871 features five programmable outputs. Selectable output-stage configurations include: active low or active high, open drain, weak pullup, push-pull, or charge pump. During power-up, the programmable outputs pull to GND with an internal 10μA current sink for $1V < V_{ABP} < V_{UVLO}$. The programmable outputs remain in their active states until PO_{timeout} period expires, and all of the programmed conditions are met for each output. Any output programmed to depend on no condition always remains in its active state (Table 22). An active-high configured output is considered asserted when that output is logic-high. No output can depend solely on \overline{MR} .

The positive voltage monitors generate fault signals (logical 0) to the MAX6870/MAX6871's logic array when an input voltage is below the programmed undervoltage threshold, or when that voltage is above the overvoltage threshold. The negative voltage monitor (IN2) generates a fault signal to the logic array when the input voltage is less negative than the undervoltage threshold, or when that voltage is more negative than the overvoltage threshold.

Registers 0Eh through 3Ah and 40h configure each of the programmable outputs. Programmable timing blocks set the PO_{timeout} period from 25μs to 1600ms for each programmable output. See register 3Ah (Table 22) to set the active state (active-high or active-low) for each programmable output and registers 11h, 15h, 1Ch, 23h, 2Ah, 31h, 35h, and 39h to select the output stage types (Tables 23 and 24), and PO_{timeout} periods (Table 25) for each output.

Control selected programmable outputs with a sum of products (Tables 10–21). Each product allows a different set of conditions to assert each output. Outputs PO3 (MAX6870)/PO1 (MAX6871) and PO6 (MAX6870)/PO4 (MAX6871) allow two sets of different conditions to assert each output. Outputs PO1 and PO2 (MAX6870 only), PO7 (MAX6870)/PO5 (MAX6871), and PO8 (MAX6870 only) allow only one set of conditions to assert each output.

For example, Product 1 of the PO3 (MAX6870—Table 12) programmable output may depend on the IN1 primary undervoltage threshold, and the states of GPI1, PO1, and PO2. Write a one to R16h[0], R17h[6], and R18h[3:2] to configure Product 1 as indicated. IN1 must be above the primary undervoltage threshold (Table 2), GPI1 must be inactive (Table 6), and PO1 (Tables 10 and 22) and PO2 (Tables 12 and 23) must be in their deasserted states for Product 1 to be a logical 1. Product 1 is equivalent to the logic statement: $V1A \cdot GPI1 \cdot PO1 \cdot PO2$.

Product 2 of PO3 (MAX6870, Table 13) may depend on an entirely different set of conditions, or the same conditions, depending on the system requirements. For example, Product 2 may depend on the IN1 undervoltage threshold, and the states of GPI2 and WDI1. Write ones to R19h[6, 0] and R1Ah[7] to configure Product 2 as indicated. IN1 must be above the primary undervoltage threshold (Table 2), GPI2 must be inactive (Table 6), and the WDI1 timer must not have expired (Tables 27 and 28) for Product 2 to be a logical 1. Product 2 is equivalent to the logic statement: $V1A \cdot GPI2 \cdot WDI1$. PO3 deasserts if either Product 1 or Product 2 is a logical 1. The logical statement: Product 1 + Product 2 determines the state of PO3.

EEPROM-Programmable Hex/Quad Power-Supply Sequencers/Supervisors with ADC

MAX6870/MAX6871

Table 10. PO1 (MAX6870 Only) Output Dependency

REGISTER ADDRESS	EEPROM MEMORY ADDRESS	BIT	OUTPUT ASSERTION CONDITIONS
0Eh	800Eh	[0]	1 = PO1 assertion depends on IN1 primary undervoltage threshold (Table 2).
		[1]	1 = PO1 assertion depends on IN2 primary undervoltage threshold (Table 3).
		[2]	1 = PO1 assertion depends on IN3 primary undervoltage threshold (Table 4).
		[3]	1 = PO1 assertion depends on IN4 primary undervoltage threshold (Table 4).
		[4]	1 = PO1 assertion depends on IN5 primary undervoltage threshold (Table 4).
		[5]	1 = PO1 assertion depends on IN6 primary undervoltage threshold (Table 4).
		[6]	1 = PO1 assertion depends on watchdog 1 (Tables 27 and 28).
		[7]	1 = PO1 assertion depends on watchdog 2 (Tables 27 and 28).
0Fh	800Fh	[0]	1 = PO1 assertion depends on IN1 secondary undervoltage/overvoltage threshold (Table 2).
		[1]	1 = PO1 assertion depends on IN2 secondary undervoltage/overvoltage threshold (Table 3).
		[2]	1 = PO1 assertion depends on IN3 secondary undervoltage/overvoltage threshold (Table 4).
		[3]	1 = PO1 assertion depends on IN4 secondary undervoltage/overvoltage threshold (Table 4).
		[4]	1 = PO1 assertion depends on IN5 secondary undervoltage/overvoltage threshold (Table 4).
		[5]	1 = PO1 assertion depends on IN6 secondary undervoltage/overvoltage threshold (Table 4).
		[6]	1 = PO1 assertion depends on GPI1 (Table 6).
		[7]	1 = PO1 assertion depends on GPI2 (Table 6).
10h	8010h	[0]	1 = PO1 assertion depends on GPI3 (Table 6).
		[1]	1 = PO1 assertion depends on GPI4 (Table 6).
		[2]	1 = PO1 assertion depends on PO2 (Table 11).
		[3]	1 = PO1 assertion depends on PO3 (Tables 12 and 13).
		[4]	1 = PO1 assertion depends on PO4 (Tables 14 and 15).
		[5]	1 = PO1 assertion depends on PO5 (Tables 16 and 17).
		[6]	1 = PO1 assertion depends on PO6 (Tables 18 and 19).
		[7]	1 = PO1 assertion depends on PO7 (Table 20).
11h	8011h	[0]	1 = PO1 assertion depends on PO8 (Table 21).
40h	8040h	[0]	1 = PO1 asserts when \overline{MR} = low (Table 7).

Table 10 only applies to PO1 of the MAX6870. Write a 0 to a bit to make the PO1 output independent of the respective signal (IN1–IN6 primary or secondary

thresholds, WDI1 or WDI2, GPI1–GPI4, \overline{MR} , or other programmable outputs).

EEPROM-Programmable Hex/Quad Power-Supply Sequencers/Supervisors with ADC

MAX6870/MAX6871

Table 11. PO2 (MAX6870 Only) Output Dependency

REGISTER ADDRESS	EEPROM MEMORY ADDRESS	BIT	OUTPUT ASSERTION CONDITIONS
12h	8012h	[0]	1 = PO2 assertion depends on IN1 primary undervoltage threshold (Table 2).
		[1]	1 = PO2 assertion depends on IN2 primary undervoltage threshold (Table 3).
		[2]	1 = PO2 assertion depends on IN3 primary undervoltage threshold (Table 4).
		[3]	1 = PO2 assertion depends on IN4 primary undervoltage threshold (Table 4).
		[4]	1 = PO2 assertion depends on IN5 primary undervoltage threshold (Table 4).
		[5]	1 = PO2 assertion depends on IN6 primary undervoltage threshold (Table 4).
		[6]	1 = PO2 assertion depends on watchdog 1 (Tables 27 and 28).
		[7]	1 = PO2 assertion depends on watchdog 2 (Tables 27 and 28).
13h	8013h	[0]	1 = PO2 assertion depends on IN1 secondary undervoltage/overvoltage threshold (Table 2).
		[1]	1 = PO2 assertion depends on IN2 secondary undervoltage/overvoltage threshold (Table 3).
		[2]	1 = PO2 assertion depends on IN3 secondary undervoltage/overvoltage threshold (Table 4).
		[3]	1 = PO2 assertion depends on IN4 secondary undervoltage/overvoltage threshold (Table 4).
		[4]	1 = PO2 assertion depends on IN5 secondary undervoltage/overvoltage threshold (Table 4).
		[5]	1 = PO2 assertion depends on IN6 secondary undervoltage/overvoltage threshold (Table 4).
		[6]	1 = PO2 assertion depends on GPI1 (Table 6).
		[7]	1 = PO2 assertion depends on GPI2 (Table 6).
14h	8014h	[0]	1 = PO2 assertion depends on GPI3 (Table 6).
		[1]	1 = PO2 assertion depends on GPI4 (Table 6).
		[2]	1 = PO2 assertion depends on PO1 (Table 10).
		[3]	1 = PO2 assertion depends on PO3 (Tables 12 and 13).
		[4]	1 = PO2 assertion depends on PO4 (Tables 14 and 15).
		[5]	1 = PO2 assertion depends on PO5 (Tables 16 and 17).
		[6]	1 = PO2 assertion depends on PO6 (Tables 18 and 19).
		[7]	1 = PO2 assertion depends on PO7 (Table 20).
15h	8015h	[0]	1 = PO2 assertion depends on PO8 (Table 21).
40h	8040h	[1]	1 = PO2 asserts when \overline{MR} = low (Table 7).

Table 11 only applies to PO2 of the MAX6870. Write a 0 to a bit to make the PO2 output independent of the respective signal (IN1–IN6 primary or secondary

thresholds, WDI1 or WDI2, GPI1–GPI4, \overline{MR} , or other programmable outputs).

EEPROM-Programmable Hex/Quad Power-Supply Sequencers/Supervisors with ADC

MAX6870/MAX6871

Table 12. PO3 (MAX6870)/PO1 (MAX6871) Output Dependency (Product 1)

REGISTER ADDRESS	EEPROM MEMORY ADDRESS	BIT	OUTPUT ASSERTION CONDITIONS
16h	8016h	[0]	1 = PO3/PO1 assertion depends on IN1 primary undervoltage threshold (Table 2).
		[1]	1 = PO3/PO1 assertion depends on IN2 primary undervoltage threshold (Table 3).
		[2]	1 = PO3/PO1 assertion depends on IN3 primary undervoltage threshold (Table 4).
		[3]	1 = PO3/PO1 assertion depends on IN4 primary undervoltage threshold (Table 4).
		[4]	1 = PO3 (MAX6870 only) assertion depends on IN5 primary undervoltage threshold (Table 4). Must be set to 0 for the MAX6871.
		[5]	1 = PO3 (MAX6870 only) assertion depends on IN6 primary undervoltage threshold (Table 4). Must be set to 0 for the MAX6871.
		[6]	1 = PO3/PO1 assertion depends on watchdog 1 (Tables 27 and 28).
17h	8017h	[7]	1 = PO3/PO1 assertion depends on watchdog 2 (Tables 27 and 28).
		[0]	1 = PO3/PO1 assertion depends on IN1 secondary undervoltage/overvoltage threshold (Table 2).
		[1]	1 = PO3/PO1 assertion depends on IN2 secondary undervoltage/overvoltage threshold (Table 3).
		[2]	1 = PO3/PO1 assertion depends on IN3 secondary undervoltage/overvoltage threshold (Table 4).
		[3]	1 = PO3/PO1 assertion depends on IN4 secondary undervoltage/overvoltage threshold (Table 4).
		[4]	1 = PO3 (MAX6870 only) assertion depends on IN5 secondary undervoltage/overvoltage threshold (Table 4). Must be set to 0 for the MAX6871.
		[5]	1 = PO3 (MAX6870 only) assertion depends on IN6 secondary undervoltage/overvoltage threshold (Table 4). Must be set to 0 for the MAX6871.
18h	8018h	[6]	1 = PO3/PO1 assertion depends on GPI1 (Table 6).
		[7]	1 = PO3/PO1 assertion depends on GPI2 (Table 6).
		[0]	1 = PO3/PO1 assertion depends on GPI3 (Table 6).
		[1]	1 = PO3/PO1 assertion depends on GPI4 (Table 6).
		[2]	1 = PO3 (MAX6870 only) assertion depends on PO1 (Table 10). Must be set to 0 for the MAX6871.
		[3]	1 = PO3 (MAX6870 only) assertion depends on PO2 (Table 11). Must be set to 0 for the MAX6871.
		[4]	1 = PO3/PO1 assertion depends on PO4 (MAX6870)/PO2 (MAX6871) (Tables 14 and 15).
[5]	1 = PO3/PO1 assertion depends on PO5 (MAX6870)/PO3 (MAX6871) (Tables 16 and 17).		
[6]	1 = PO3/PO1 assertion depends on PO6 (MAX6870)/PO4 (MAX6871) (Tables 18 and 19).		
[7]	1 = PO3/PO1 assertion depends on PO7 (MAX6870)/PO5 (MAX6871) (Table 20).		
1Ch	801Ch	[0]	1 = PO3 (MAX6870 only) assertion depends on PO8 (Table 21). Must be set to 0 for the MAX6871.
40h	8040h	[2]	1 = PO3/PO1 asserts when \overline{MR} = low (Table 7).

Table 12 only applies to PO3 of the MAX6870 and PO1 of the MAX6871. Write a 0 to a bit to make the PO3/PO1 output independent of the respective signal (IN_ primary or secondary thresholds, WDI1 or WDI2, GPI1–GPI4,

\overline{MR} , or other programmable outputs). See Table 13 for Product 2. PO3 (MAX6870)/PO1 (MAX6871) deasserts when Product 1 or Product 2 = 1.

EEPROM-Programmable Hex/Quad Power-Supply Sequencers/Supervisors with ADC

MAX6870/MAX6871

Table 13. PO3 (MAX6870)/PO1 (MAX6871) Output Dependency (Product 2)

REGISTER ADDRESS	EEPROM MEMORY ADDRESS	BIT	OUTPUT ASSERTION CONDITIONS
19h	8019h	[0]	1 = PO3/PO1 assertion depends on IN1 primary undervoltage threshold (Table 2).
		[1]	1 = PO3/PO1 assertion depends on IN2 primary undervoltage threshold (Table 3).
		[2]	1 = PO3/PO1 assertion depends on IN3 primary undervoltage threshold (Table 4).
		[3]	1 = PO3/PO1 assertion depends on IN4 primary undervoltage threshold (Table 4).
		[4]	1 = PO3 (MAX6870 only) assertion depends on IN5 primary undervoltage threshold (Table 4). Must be set to 0 for the MAX6871.
		[5]	1 = PO3 (MAX6870 only) assertion depends on IN6 primary undervoltage threshold (Table 4). Must be set to 0 for the MAX6871.
		[6]	1 = PO3/PO1 assertion depends on watchdog 1 (Tables 27 and 28).
		[7]	1 = PO3/PO1 assertion depends on watchdog 2 (Tables 27 and 28).
1Ah	801Ah	[0]	1 = PO3/PO1 assertion depends on IN1 secondary undervoltage/overvoltage threshold (Table 2).
		[1]	1 = PO3/PO1 assertion depends on IN2 secondary undervoltage/overvoltage threshold (Table 3).
		[2]	1 = PO3/PO1 assertion depends on IN3 secondary undervoltage/overvoltage threshold (Table 4).
		[3]	1 = PO3/PO1 assertion depends on IN4 secondary undervoltage/overvoltage threshold (Table 4).
		[4]	1 = PO3 (MAX6870 only) assertion depends on IN5 secondary undervoltage/overvoltage threshold (Table 4). Must be set to 0 for the MAX6871.
		[5]	1 = PO3 (MAX6870 only) assertion depends on IN6 secondary undervoltage/overvoltage threshold (Table 4). Must be set to 0 for the MAX6871.
		[6]	1 = PO3/PO1 assertion depends on GPI1 (Table 6).
		[7]	1 = PO3/PO1 assertion depends on GPI2 (Table 6).
1Bh	801Bh	[0]	1 = PO3/PO1 assertion depends on GPI3 (Table 6).
		[1]	1 = PO3/PO1 assertion depends on GPI4 (Table 6).
		[2]	1 = PO3 (MAX6870 only) assertion depends on PO1 (Table 10). Must be set to 0 for the MAX6871.
		[3]	1 = PO3 (MAX6870 only) assertion depends on PO2 (Table 11). Must be set to 0 for the MAX6871.
		[4]	1 = PO3/PO1 assertion depends on PO4 (MAX6870)/PO2 (MAX6871) (Tables 14 and 15).
		[5]	1 = PO3/PO1 assertion depends on PO5 (MAX6870)/PO3 (MAX6871) (Tables 16 and 17).
		[6]	1 = PO3/PO1 assertion depends on PO6 (MAX6870)/PO4 (MAX6871) (Tables 18 and 19).
		[7]	1 = PO3/PO1 assertion depends on PO7 (MAX6870)/PO5 (MAX6871) (Table 20).
1Ch	801Ch	[1]	1 = PO3 (MAX6870 only) assertion depends on PO8 (Table 21). Must be set to 0 for the MAX6871.
40h	8040h	[2]	1 = PO3/PO1 asserts when \overline{MR} = low (Table 7).

Table 13 only applies to PO3 of the MAX6870 and PO1 of the MAX6871. Write a 0 to a bit to make the PO3/PO1 output independent of the respective signal (IN_ primary or secondary thresholds, WDI1 or WDI2, GPI1–GPI4,

\overline{MR} , or other programmable outputs). See Table 12 for Product 1. PO3 (MAX6870)/PO1 (MAX6871) deasserts when Product 1 or Product 2 = 1.

EEPROM-Programmable Hex/Quad Power-Supply Sequencers/Supervisors with ADC

MAX6870/MAX6871

Table 14. PO4 (MAX6870)/PO2 (MAX6871) Output Dependency (Product 1)

REGISTER ADDRESS	EEPROM MEMORY ADDRESS	BIT	OUTPUT ASSERTION CONDITIONS
1Dh	801Dh	[0]	1 = PO4/PO2 assertion depends on IN1 primary undervoltage threshold (Table 2).
		[1]	1 = PO4/PO2 assertion depends on IN2 primary undervoltage threshold (Table 3).
		[2]	1 = PO4/PO2 assertion depends on IN3 primary undervoltage threshold (Table 4).
		[3]	1 = PO4/PO2 assertion depends on IN4 primary undervoltage threshold (Table 4).
		[4]	1 = PO4 (MAX6870 only) assertion depends on IN5 primary undervoltage threshold (Table 4). Must be set to 0 for the MAX6871.
		[5]	1 = PO4 (MAX6870 only) assertion depends on IN6 primary undervoltage threshold (Table 4). Must be set to 0 for the MAX6871.
		[6]	1 = PO4/PO2 assertion depends on watchdog 1 (Tables 27 and 28).
1Eh	801Eh	[7]	1 = PO4/PO2 assertion depends on watchdog 2 (Tables 27 and 28).
		[0]	1 = PO4/PO2 assertion depends on IN1 secondary undervoltage/overvoltage threshold (Table 2).
		[1]	1 = PO4/PO2 assertion depends on IN2 secondary undervoltage/overvoltage threshold (Table 3).
		[2]	1 = PO4/PO2 assertion depends on IN3 secondary undervoltage/overvoltage threshold (Table 4).
		[3]	1 = PO4/PO2 assertion depends on IN4 secondary undervoltage/overvoltage threshold (Table 4).
		[4]	1 = PO4 (MAX6870 only) assertion depends on IN5 secondary undervoltage/overvoltage threshold (Table 4). Must be set to 0 for the MAX6871.
		[5]	1 = PO4 (MAX6870 only) assertion depends on IN6 secondary undervoltage/overvoltage threshold (Table 4). Must be set to 0 for the MAX6871.
1Fh	801Fh	[6]	1 = PO4/PO2 assertion depends on GPI1 (Table 6).
		[7]	1 = PO4/PO2 assertion depends on GPI2 (Table 6).
		[0]	1 = PO4/PO2 assertion depends on GPI3 (Table 6).
		[1]	1 = PO4/PO2 assertion depends on GPI4 (Table 6).
		[2]	1 = PO4 (MAX6870 only) assertion depends on PO1 (Table 10). Must be set to 0 for the MAX6871.
		[3]	1 = PO4 (MAX6870 only) assertion depends on PO2 (Table 11). Must be set to 0 for the MAX6871.
		[4]	1 = PO4/PO2 assertion depends on PO3 (MAX6870)/PO1 (MAX6871) (Tables 12 and 13).
[5]	1 = PO4/PO2 assertion depends on PO5 (MAX6870)/PO3 (MAX6871) (Tables 16 and 17).		
[6]	1 = PO4/PO2 assertion depends on PO6 (MAX6870)/PO4 (MAX6871) (Tables 18 and 19).		
[7]	1 = PO4/PO2 assertion depends on PO7 (MAX6870)/PO5 (MAX6871) (Table 20).		
23h	8023h	[0]	1 = PO4 (MAX6870 only) assertion depends on PO8 (Table 21). Must be set to 0 for the MAX6871.
40h	8040h	[3]	1 = PO4/PO2 asserts when \overline{MR} = low (Table 7).

Table 14 only applies to PO4 of the MAX6870 and PO2 of the MAX6871. Write a 0 to a bit to make the PO4/PO2 output independent of the respective signal (IN_ primary or secondary thresholds, WDI1 or WDI2, GPI1–GPI4,

\overline{MR} , or other programmable outputs). See Table 15 for Product 2. PO4 (MAX6870)/PO2 (MAX6871) deasserts when Product 1 or Product 2 = 1.

EEPROM-Programmable Hex/Quad Power-Supply Sequencers/Supervisors with ADC

MAX6870/MAX6871

Table 15. PO4 (MAX6870)/PO2 (MAX6871) Output Dependency (Product 2)

REGISTER ADDRESS	EEPROM MEMORY ADDRESS	BIT	OUTPUT ASSERTION CONDITIONS
20h	8020h	[0]	1 = PO4/PO2 assertion depends on IN1 primary undervoltage threshold (Table 2).
		[1]	1 = PO4/PO2 assertion depends on IN2 primary undervoltage threshold (Table 3).
		[2]	1 = PO4/PO2 assertion depends on IN3 primary undervoltage threshold (Table 4).
		[3]	1 = PO4/PO2 assertion depends on IN4 primary undervoltage threshold (Table 4).
		[4]	1 = PO4 (MAX6870 only) assertion depends on IN5 primary undervoltage threshold (Table 4). Must be set to 0 for the MAX6871.
		[5]	1 = PO4 (MAX6870 only) assertion depends on IN6 primary undervoltage threshold (Table 4). Must be set to 0 for the MAX6871.
		[6]	1 = PO4/PO2 assertion depends on watchdog 1 (Tables 27 and 28).
21h	8021h	[7]	1 = PO4/PO2 assertion depends on watchdog 2 (Tables 27 and 28).
		[0]	1 = PO4/PO2 assertion depends on IN1 secondary undervoltage/overvoltage threshold (Table 2).
		[1]	1 = PO4/PO2 assertion depends on IN2 secondary undervoltage/overvoltage threshold (Table 3).
		[2]	1 = PO4/PO2 assertion depends on IN3 secondary undervoltage/overvoltage threshold (Table 4).
		[3]	1 = PO4/PO2 assertion depends on IN4 secondary undervoltage/overvoltage threshold (Table 4).
		[4]	1 = PO4 (MAX6870 only) assertion depends on IN5 secondary undervoltage/overvoltage threshold (Table 4). Must be set to 0 for the MAX6871.
		[5]	1 = PO4 (MAX6870 only) assertion depends on IN6 secondary undervoltage/overvoltage threshold (Table 4). Must be set to 0 for the MAX6871.
22h	8022h	[6]	1 = PO4/PO2 assertion depends on GPI1 (Table 6).
		[7]	1 = PO4/PO2 assertion depends on GPI2 (Table 6).
		[0]	1 = PO4/PO2 assertion depends on GPI3 (Table 6).
		[1]	1 = PO4/PO2 assertion depends on GPI4 (Table 6).
		[2]	1 = PO4 (MAX6870 only) assertion depends on PO1 (Table 10). Must be set to 0 for the MAX6871.
		[3]	1 = PO4 (MAX6870 only) assertion depends on PO2 (Table 11). Must be set to 0 for the MAX6871.
		[4]	1 = PO4/PO2 assertion depends on PO3 (MAX6870)/PO1 (MAX6871) (Tables 12 and 13).
[5]	1 = PO4/PO2 assertion depends on PO5 (MAX6870)/PO3 (MAX6871) (Tables 16 and 17).		
[6]	1 = PO4/PO2 assertion depends on PO6 (MAX6870)/PO4 (MAX6871) (Tables 18 and 19).		
[7]	1 = PO4/PO2 assertion depends on PO7 (MAX6870)/PO5 (MAX6871) (Table 20).		
23h	8023h	[1]	1 = PO4 (MAX6870 only) assertion depends on PO8 (Table 21). Must be set to 0 for the MAX6871.
40h	8040h	[3]	1 = PO4/PO2 asserts when \overline{MR} = low (Table 7).

Table 15 only applies to PO4 of the MAX6870 and PO2 of the MAX6871. Write a 0 to a bit to make the PO4/PO2 output independent of the respective signal (IN_ primary or secondary thresholds, WDI1 or WDI2, GPI1 to GPI4,

\overline{MR} , or other programmable outputs). See Table 14 for Product 1. PO4 (MAX6870)/PO2 (MAX6871) deasserts when Product 1 or Product 2 = 1.

EEPROM-Programmable Hex/Quad Power-Supply Sequencers/Supervisors with ADC

MAX6870/MAX6871

Table 16. PO5 (MAX6870)/PO3 (MAX6871) Output Dependency (Product 1)

REGISTER ADDRESS	EEPROM MEMORY ADDRESS	BIT	OUTPUT ASSERTION CONDITIONS
24h	8024h	[0]	1 = PO5/PO3 assertion depends on IN1 primary undervoltage threshold (Table 2).
		[1]	1 = PO5/PO3 assertion depends on IN2 primary undervoltage threshold (Table 3).
		[2]	1 = PO5/PO3 assertion depends on IN3 primary undervoltage threshold (Table 4).
		[3]	1 = PO5/PO3 assertion depends on IN4 primary undervoltage threshold (Table 4).
		[4]	1 = PO5 (MAX6870 only) assertion depends on IN5 primary undervoltage threshold (Table 4). Must be set to 0 for the MAX6871.
		[5]	1 = PO5 (MAX6870 only) assertion depends on IN6 primary undervoltage threshold (Table 4). Must be set to 0 for the MAX6871.
		[6]	1 = PO5/PO3 assertion depends on watchdog 1 (Tables 27 and 28).
		[7]	1 = PO5/PO3 assertion depends on watchdog 2 (Tables 27 and 28).
25h	8025h	[0]	1 = PO5/PO3 assertion depends on IN1 secondary undervoltage/overvoltage threshold (Table 2).
		[1]	1 = PO5/PO3 assertion depends on IN2 secondary undervoltage/overvoltage threshold (Table 3).
		[2]	1 = PO5/PO3 assertion depends on IN3 secondary undervoltage/overvoltage threshold (Table 4).
		[3]	1 = PO5/PO3 assertion depends on IN4 secondary undervoltage/overvoltage threshold (Table 4).
		[4]	1 = PO5 (MAX6870 only) assertion depends on IN5 secondary undervoltage/overvoltage threshold (Table 4). Must be set to 0 for the MAX6871.
		[5]	1 = PO5 (MAX6870 only) assertion depends on IN6 secondary undervoltage/overvoltage threshold (Table 4). Must be set to 0 for the MAX6871.
		[6]	1 = PO5/PO3 assertion depends on GPI1 (Table 6).
		[7]	1 = PO5/PO3 assertion depends on GPI2 (Table 6).
26h	8026h	[0]	1 = PO5/PO3 assertion depends on GPI3 (Table 6).
		[1]	1 = PO5/PO3 assertion depends on GPI4 (Table 6).
		[2]	1 = PO5 (MAX6870 only) assertion depends on PO1 (Table 10). Must be set to 0 for the MAX6871.
		[3]	1 = PO5 (MAX6870 only) assertion depends on PO2 (Table 11). Must be set to 0 for the MAX6871.
		[4]	1 = PO5/PO3 assertion depends on PO3 (MAX6870)/PO1 (MAX6871) (Tables 12 and 13).
		[5]	1 = PO5/PO3 assertion depends on PO4 (MAX6870)/PO2 (MAX6871) (Tables 14 and 15).
		[6]	1 = PO5/PO3 assertion depends on PO6 (MAX6870)/PO4 (MAX6871) (Tables 18 and 19).
		[7]	1 = PO5/PO3 assertion depends on PO7 (MAX6870)/PO5 (MAX6871) (Table 20).
2Ah	802Ah	[0]	1 = PO5 (MAX6870 only) assertion depends on PO8 (Table 21). Must be set to 0 for the MAX6871.
40h	8040h	[4]	1 = PO5/PO3 asserts when \overline{MR} = low (Table 7).

Table 16 only applies to PO5 of the MAX6870 and PO3 of the MAX6871. Write a 0 to a bit to make the PO5/PO3 output independent of the respective signal (IN_ primary or secondary thresholds, WDI1 or WDI2, GPI1–GPI4,

\overline{MR} , or other programmable outputs). See Table 17 for Product 2. PO5 (MAX6870)/PO3 (MAX6871) deasserts when Product 1 or Product 2 = 1.

EEPROM-Programmable Hex/Quad Power-Supply Sequencers/Supervisors with ADC

MAX6870/MAX6871

Table 17. PO5 (MAX6870)/PO3 (MAX6871) Output Dependency (Product 2)

REGISTER ADDRESS	EEPROM MEMORY ADDRESS	BIT	OUTPUT ASSERTION CONDITIONS
27h	8027h	[0]	1 = PO5/PO3 assertion depends on IN1 primary undervoltage threshold (Table 2).
		[1]	1 = PO5/PO3 assertion depends on IN2 primary undervoltage threshold (Table 3).
		[2]	1 = PO5/PO3 assertion depends on IN3 primary undervoltage threshold (Table 4).
		[3]	1 = PO5/PO3 assertion depends on IN4 primary undervoltage threshold (Table 4).
		[4]	1 = PO5 (MAX6870 only) assertion depends on IN5 primary undervoltage threshold (Table 4). Must be set to 0 for the MAX6871.
		[5]	1 = PO5 (MAX6870 only) assertion depends on IN6 primary undervoltage threshold (Table 4). Must be set to 0 for the MAX6871.
		[6]	1 = PO5/PO3 assertion depends on watchdog 1 (Tables 27 and 28).
28h	8028h	[7]	1 = PO5/PO3 assertion depends on watchdog 2 (Tables 27 and 28).
		[0]	1 = PO5/PO3 assertion depends on IN1 secondary undervoltage/overvoltage threshold (Table 2).
		[1]	1 = PO5/PO3 assertion depends on IN2 secondary undervoltage/overvoltage threshold (Table 3).
		[2]	1 = PO5/PO3 assertion depends on IN3 secondary undervoltage/overvoltage threshold (Table 4).
		[3]	1 = PO5/PO3 assertion depends on IN4 secondary undervoltage/overvoltage threshold (Table 4).
		[4]	1 = PO5 (MAX6870 only) assertion depends on IN5 secondary undervoltage/overvoltage threshold (Table 4). Must be set to 0 for the MAX6871.
		[5]	1 = PO5 (MAX6870 only) assertion depends on IN6 secondary undervoltage/overvoltage threshold (Table 4). Must be set to 0 for the MAX6871.
29h	8029h	[6]	1 = PO5/PO3 assertion depends on GPI1 (Table 6).
		[7]	1 = PO5/PO3 assertion depends on GPI2 (Table 6).
		[0]	1 = PO5/PO3 assertion depends on GPI3 (Table 6).
		[1]	1 = PO5/PO3 assertion depends on GPI4 (Table 6).
		[2]	1 = PO5 (MAX6870 only) assertion depends on PO1 (Table 10). Must be set to 0 for the MAX6871.
		[3]	1 = PO5 (MAX6870 only) assertion depends on PO2 (Table 11). Must be set to 0 for the MAX6871.
		[4]	1 = PO5/PO3 assertion depends on PO3 (MAX6870)/PO1 (MAX6871) (Tables 12 and 13).
[5]	1 = PO5/PO3 assertion depends on PO4 (MAX6870)/PO2 (MAX6871) (Tables 14 and 15).		
[6]	1 = PO5/PO3 assertion depends on PO6 (MAX6870)/PO4 (MAX6871) (Tables 18 and 19).		
[7]	1 = PO5/PO3 assertion depends on PO7 (MAX6870)/PO5 (MAX6871) (Table 20).		
3Bh	803Bh	[4]	1 = PO5 (MAX6870 only) assertion depends on PO8 (Table 21). Must be set to 0 for the MAX6871.
40h	8040h	[4]	1 = PO5/PO3 asserts when \overline{MR} = low (Table 7).

Table 17 only applies to PO5 of the MAX6870 and PO3 of the MAX6871. Write a 0 to a bit to make the PO5/PO3 output independent of the respective signal (IN_ primary or secondary thresholds, WD11 or WD12, GPI1–GPI4,

\overline{MR} , or other programmable outputs). See Table 16 for Product 1. PO5 (MAX6870)/PO3 (MAX6871) deasserts when Product 1 or Product 2 = 1.

EEPROM-Programmable Hex/Quad Power-Supply Sequencers/Supervisors with ADC

MAX6870/MAX6871

Table 18. PO6 (MAX6870)/PO4 (MAX6871) Output Dependency (Product 1)

REGISTER ADDRESS	EEPROM MEMORY ADDRESS	BIT	OUTPUT ASSERTION CONDITIONS
2Bh	802Bh	[0]	1 = PO6/PO4 assertion depends on IN1 primary undervoltage threshold (Table 2).
		[1]	1 = PO6/PO4 assertion depends on IN2 primary undervoltage threshold (Table 3).
		[2]	1 = PO6/PO4 assertion depends on IN3 primary undervoltage threshold (Table 4).
		[3]	1 = PO6/PO4 assertion depends on IN4 primary undervoltage threshold (Table 4).
		[4]	1 = PO6 (MAX6870 only) assertion depends on IN5 primary undervoltage threshold (Table 4). Must be set to 0 for the MAX6871.
		[5]	1 = PO6 (MAX6870 only) assertion depends on IN6 primary undervoltage threshold (Table 4). Must be set to 0 for the MAX6871.
		[6]	1 = PO6/PO4 assertion depends on watchdog 1 (Tables 27 and 28).
		[7]	1 = PO6/PO4 assertion depends on watchdog 2 (Tables 27 and 28).
2Ch	802Ch	[0]	1 = PO6/PO4 assertion depends on IN1 secondary undervoltage/overvoltage threshold (Table 2).
		[1]	1 = PO6/PO4 assertion depends on IN2 secondary undervoltage/overvoltage threshold (Table 3).
		[2]	1 = PO6/PO4 assertion depends on IN3 secondary undervoltage/overvoltage threshold (Table 4).
		[3]	1 = PO6/PO4 assertion depends on IN4 secondary undervoltage/overvoltage threshold (Table 4).
		[4]	1 = PO6 (MAX6870 only) assertion depends on IN5 secondary undervoltage/overvoltage threshold (Table 4). Must be set to 0 for the MAX6871.
		[5]	1 = PO6 (MAX6870 only) assertion depends on IN6 secondary undervoltage/overvoltage threshold (Table 4). Must be set to 0 for the MAX6871.
		[6]	1 = PO6/PO4 assertion depends on GPI1 (Table 6).
		[7]	1 = PO6/PO4 assertion depends on GPI2 (Table 6).
2Dh	802Dh	[0]	1 = PO6/PO4 assertion depends on GPI3 (Table 6).
		[1]	1 = PO6/PO4 assertion depends on GPI4 (Table 6).
		[2]	1 = PO6 (MAX6870 only) assertion depends on PO1 (Table 10). Must be set to 0 for the MAX6871.
		[3]	1 = PO6 (MAX6870 only) assertion depends on PO2 (Table 11). Must be set to 0 for the MAX6871.
		[4]	1 = PO6/PO4 assertion depends on PO3 (MAX6870)/PO1 (MAX6871) (Tables 12 and 13).
		[5]	1 = PO6/PO4 assertion depends on PO4 (MAX6870)/PO2 (MAX6871) (Tables 14 and 15).
		[6]	1 = PO6/PO4 assertion depends on PO5 (MAX6870)/PO3 (MAX6871) (Tables 16 and 17).
		[7]	1 = PO6/PO4 assertion depends on PO7 (MAX6870)/PO5 (MAX6871) (Table 20).
31h	8031h	[0]	1 = PO6 (MAX6870 only) assertion depends on PO8 (Table 21). Must be set to 0 for the MAX6871.
40h	8040h	[5]	1 = PO6/PO4 asserts when \overline{MR} = low (Table 7).

Table 18 only applies to PO6 of the MAX6870 and PO4 of the MAX6871. Write a 0 to a bit to make the PO6/PO4 output independent of the respective signal (IN_ primary or secondary thresholds, WDI1 or WDI2, GPI1–GPI4,

\overline{MR} , or other programmable outputs). See Table 19 for Product 2. PO6 (MAX6870)/PO4 (MAX6871) deasserts when Product 1 or Product 2 = 1.

EEPROM-Programmable Hex/Quad Power-Supply Sequencers/Supervisors with ADC

MAX6870/MAX6871

Table 19. PO6 (MAX6870)/PO4 (MAX6871) Output Dependency (Product 2)

REGISTER ADDRESS	EEPROM MEMORY ADDRESS	BIT	OUTPUT ASSERTION CONDITIONS
2Eh	802Eh	[0]	1 = PO6/PO4 assertion depends on IN1 primary undervoltage threshold (Table 2).
		[1]	1 = PO6/PO4 assertion depends on IN2 primary undervoltage threshold (Table 3).
		[2]	1 = PO6/PO4 assertion depends on IN3 primary undervoltage threshold (Table 4).
		[3]	1 = PO6/PO4 assertion depends on IN4 primary undervoltage threshold (Table 4).
		[4]	1 = PO6 (MAX6870 only) assertion depends on IN5 primary undervoltage threshold (Table 4). Must be set to 0 for the MAX6871.
		[5]	1 = PO6 (MAX6870 only) assertion depends on IN6 primary undervoltage threshold (Table 4). Must be set to 0 for the MAX6871.
		[6]	1 = PO6/PO4 assertion depends on watchdog 1 (Tables 27 and 28).
2Fh	802Fh	[7]	1 = PO6/PO4 assertion depends on watchdog 2 (Tables 27 and 28).
		[0]	1 = PO6/PO4 assertion depends on IN1 secondary undervoltage/overvoltage threshold (Table 2).
		[1]	1 = PO6/PO4 assertion depends on IN2 secondary undervoltage/overvoltage threshold (Table 3).
		[2]	1 = PO6/PO4 assertion depends on IN3 secondary undervoltage/overvoltage threshold (Table 4).
		[3]	1 = PO6/PO4 assertion depends on IN4 secondary undervoltage/overvoltage threshold (Table 4).
		[4]	1 = PO6 (MAX6870 only) assertion depends on IN5 secondary undervoltage/overvoltage threshold (Table 4). Must be set to 0 for the MAX6871.
		[5]	1 = PO6 (MAX6870 only) assertion depends on IN6 secondary undervoltage/overvoltage threshold (Table 4). Must be set to 0 for the MAX6871.
30h	8030h	[6]	1 = PO6/PO4 assertion depends on GPI1 (Table 6).
		[7]	1 = PO6/PO4 assertion depends on GPI2 (Table 6).
		[0]	1 = PO6/PO4 assertion depends on GPI3 (Table 6).
		[1]	1 = PO6/PO4 assertion depends on GPI4 (Table 6).
		[2]	1 = PO6 (MAX6870 only) assertion depends on PO1 (Table 10). Must be set to 0 for the MAX6871.
		[3]	1 = PO6 (MAX6870 only) assertion depends on PO2 (Table 11). Must be set to 0 for the MAX6871.
		[4]	1 = PO6/PO4 assertion depends on PO3 (MAX6870)/PO1 (MAX6871) (Tables 12 and 13).
[5]	1 = PO6/PO4 assertion depends on PO4 (MAX6870)/PO2 (MAX6871) (Tables 14 and 15).		
[6]	1 = PO6/PO4 assertion depends on PO5 (MAX6870)/PO3 (MAX6871) (Tables 16 and 17).		
[7]	1 = PO6/PO4 assertion depends on PO7 (MAX6870)/PO5 (MAX6871) (Table 20).		
3Bh	803Bh	[5]	1 = PO6 (MAX6870 only) assertion depends on PO8 (Table 21). Must be set to 0 for the MAX6871.
40h	8040h	[5]	1 = PO6/PO4 asserts when \overline{MR} = low (Table 7).

Table 19 only applies to PO6 of the MAX6870 and PO4 of the MAX6871. Write a 0 to a bit to make the PO6/PO4 output independent of the respective signal (IN_ primary or secondary thresholds, WD11 or WD12, GPI1–GPI4,

\overline{MR} , or other programmable outputs). See Table 18 for Product 1. PO6 (MAX6870)/PO4 (MAX6871) deasserts when Product 1 or Product 2 = 1.

EEPROM-Programmable Hex/Quad Power-Supply Sequencers/Supervisors with ADC

MAX6870/MAX6871

Table 20. PO7 (MAX6870)/PO5 (MAX6871) Output Dependency

REGISTER ADDRESS	EEPROM MEMORY ADDRESS	BIT	OUTPUT ASSERTION CONDITIONS
32h	8032h	[0]	1 = PO7/PO5 assertion depends on IN1 primary undervoltage threshold (Table 2).
		[1]	1 = PO7/PO5 assertion depends on IN2 primary undervoltage threshold (Table 3).
		[2]	1 = PO7/PO5 assertion depends on IN3 primary undervoltage threshold (Table 4).
		[3]	1 = PO7/PO5 assertion depends on IN4 primary undervoltage threshold (Table 4).
		[4]	1 = PO7 (MAX6870 only) assertion depends on IN5 primary undervoltage threshold (Table 4). Must be set to 0 for the MAX6871.
		[5]	1 = PO7 (MAX6870 only) assertion depends on IN6 primary undervoltage threshold (Table 4). Must be set to 0 for the MAX6871.
		[6]	1 = PO7/PO5 assertion depends on watchdog 1 (Tables 27 and 28).
		[7]	1 = PO7/PO5 assertion depends on watchdog 2 (Tables 27 and 28).
33h	8033h	[0]	1 = PO7/PO5 assertion depends on IN1 secondary undervoltage/overvoltage threshold (Table 2).
		[1]	1 = PO7/PO5 assertion depends on IN2 secondary undervoltage/overvoltage threshold (Table 3).
		[2]	1 = PO7/PO5 assertion depends on IN3 secondary undervoltage/overvoltage threshold (Table 4).
		[3]	1 = PO7/PO5 assertion depends on IN4 secondary undervoltage/overvoltage threshold (Table 4).
		[4]	1 = PO7 (MAX6870 only) assertion depends on IN5 secondary undervoltage/overvoltage threshold (Table 4). Must be set to 0 for the MAX6871.
		[5]	1 = PO7 (MAX6870 only) assertion depends on IN6 secondary undervoltage/overvoltage threshold (Table 4). Must be set to 0 for the MAX6871.
		[6]	1 = PO7/PO5 assertion depends on GPI1 (Table 6).
		[7]	1 = PO7/PO5 assertion depends on GPI2 (Table 6).
34h	8034h	[0]	1 = PO7/PO5 assertion depends on GPI3 (Table 6).
		[1]	1 = PO7/PO5 assertion depends on GPI4 (Table 6).
		[2]	1 = PO7 (MAX6870 only) assertion depends on PO1 (Table 10). Must be set to 0 for the MAX6871.
		[3]	1 = PO7 (MAX6870 only) assertion depends on PO2 (Table 11). Must be set to 0 for the MAX6871.
		[4]	1 = PO7/PO5 assertion depends on PO3 (MAX6870)/PO1 (MAX6871) (Tables 12 and 13).
		[5]	1 = PO7/PO5 assertion depends on PO4 (MAX6870)/PO2 (MAX6871) (Tables 14 and 15).
		[6]	1 = PO7/PO5 assertion depends on PO5 (MAX6870)/PO3 (MAX6871) (Tables 16 and 17).
		[7]	1 = PO7/PO5 assertion depends on PO6 (MAX6870)/PO4 (MAX6871) (Tables 18 and 19).
35h	8035h	[0]	1 = PO7 (MAX6870 only) assertion depends on PO8 (Table 21). Must be set to 0 for the MAX6871.
40h	8040h	[6]	1 = PO7 asserts when \overline{MR} = low (Table 7).

Table 20 only applies to PO7 of the MAX6870 and PO5 of the MAX6871. Write a 0 to a bit to make the PO7/PO5 output independent of the respective signal (IN_ primary

or secondary thresholds, WDI1 or WDI2, GPI1–GPI4, \overline{MR} , or other programmable outputs).

EEPROM-Programmable Hex/Quad Power-Supply Sequencers/Supervisors with ADC

MAX6870/MAX6871

Table 21. PO8 (MAX6870 only) Output Dependency

REGISTER ADDRESS	EEPROM MEMORY ADDRESS	BIT	OUTPUT ASSERTION CONDITIONS
36h	8036h	[0]	1 = PO8 assertion depends on IN1 primary undervoltage threshold (Table 2).
		[1]	1 = PO8 assertion depends on IN2 primary undervoltage threshold (Table 3).
		[2]	1 = PO8 assertion depends on IN3 primary undervoltage threshold (Table 4).
		[3]	1 = PO8 assertion depends on IN4 primary undervoltage threshold (Table 4).
		[4]	1 = PO8 assertion depends on IN5 primary undervoltage threshold (Table 4).
		[5]	1 = PO8 assertion depends on IN6 primary undervoltage threshold (Table 4).
		[6]	1 = PO8 assertion depends on watchdog 1 (Tables 27 and 28).
		[7]	1 = PO8 assertion depends on watchdog 2 (Tables 27 and 28).
37h	8037h	[0]	1 = PO8 assertion depends on IN1 secondary undervoltage/overvoltage threshold (Table 2).
		[1]	1 = PO8 assertion depends on IN2 secondary undervoltage/overvoltage threshold (Table 3).
		[2]	1 = PO8 assertion depends on IN3 secondary undervoltage/overvoltage threshold (Table 4).
		[3]	1 = PO8 assertion depends on IN4 secondary undervoltage/overvoltage threshold (Table 4).
		[4]	1 = PO8 assertion depends on IN5 secondary undervoltage/overvoltage threshold (Table 4).
		[5]	1 = PO8 assertion depends on IN6 secondary undervoltage/overvoltage threshold (Table 4).
		[6]	1 = PO8 assertion depends on GPI1 (Table 6).
		[7]	1 = PO8 assertion depends on GPI2 (Table 6).
38h	8038h	[0]	1 = PO8 assertion depends on GPI3 (Table 6).
		[1]	1 = PO8 assertion depends on GPI4 (Table 6).
		[2]	1 = PO8 assertion depends on PO1 (Table 10).
		[3]	1 = PO8 assertion depends on PO2 (Table 11).
		[4]	1 = PO8 assertion depends on PO3 (Tables 12 and 13).
		[5]	1 = PO8 assertion depends on PO4 (Tables 14 and 15).
		[6]	1 = PO8 assertion depends on PO5 (Tables 16 and 17).
		[7]	1 = PO8 assertion depends on PO6 (Tables 18 and 19).
39h	8039h	[0]	1 = PO8 assertion depends on PO7 (Table 20).
40h	8040h	[7]	1 = PO8 asserts when \overline{MR} = low (Table 7).

Table 21 only applies to PO8 of the MAX6870. Write a 0 to a bit to make the PO8 output independent of the respective signal (IN1–IN6 primary or secondary thresholds, WDI1 or WDI2, GPI1–GPI4, \overline{MR} , or other programmable outputs).

Output Stage Configurations

Independently program each programmable output as active-high or active-low (Table 22). Additionally, program each programmable output as weak pullup, push-pull, open-drain, or charge pump (Tables 23 and 24). Every programmable output can be configured as open-drain or weak pullup; however, only PO1–PO4 (MAX6870) or PO1/PO2 (MAX6871) can be configured

as charge-pump outputs, and only PO5–PO8 (MAX6870) or PO3/PO4/PO5 (MAX6871) can be configured as push-pull outputs. Finally, set the PO_ timeout period for each programmable output (Table 25).

An internal 10k Ω resistor provides the pullup resistance for outputs configured as weak pullup stages. Program each weak pullup output stage to refer to ABP or one of the IN3–IN6 inputs. The programmable outputs source up to 10mA and sink up to 4mA when configured as push-pull stages. Program each push-pull output stage to reference to one of IN3–IN6. PO1–PO4 (MAX6870)/PO1/PO2 (MAX6871) pull to $V_{ABP} + 5V$ when configured as charge-pump outputs.

EEPROM-Programmable Hex/Quad Power-Supply Sequencers/Supervisors with ADC

MAX6870/MAX6871

Table 22. Programmable Output Active States

REGISTER ADDRESS	EEPROM MEMORY ADDRESS	BIT RANGE	DESCRIPTION
3Ah	803Ah	[0]	PO1 (MAX6870 only). 0 = active-low, 1 = active-high.
		[1]	PO2 (MAX6870 only). 0 = active-low, 1 = active-high.
		[2]	PO3 (MAX6870)/PO1 (MAX6871). 0 = active-low, 1 = active-high.
		[3]	PO4 (MAX6870)/PO2 (MAX6871). 0 = active-low, 1 = active-high.
		[4]	PO5 (MAX6870)/PO3 (MAX6871). 0 = active-low, 1 = active-high.
		[5]	PO6 (MAX6870)/PO4 (MAX6871). 0 = active-low, 1 = active-high.
		[6]	PO7 (MAX6870)/PO5 (MAX6871). 0 = active-low, 1 = active-high.
		[7]	PO8 (MAX6870 only). 0 = active-low, 1 = active-high.

Table 23. Programmable Output Stage Options (MAX6870)

REGISTER ADDRESS	EEPROM MEMORY ADDRESS	BIT RANGE	AFFECTED OUTPUT	DESCRIPTION
11h	8011h	[6:4]	PO1	000 = open-drain, 001 = weak pullup to IN3, 010 = weak pullup to IN4, 011 = weak pullup to IN5, 100 = weak pullup to IN6, 101 = weak pullup to ABP, 110 = charge-pump output, 111 = not used.
15h	8015h	[6:4]	PO2	
1Ch	801Ch	[7:5]	PO3	
23h	8023h	[7:5]	PO4	
2Ah	802Ah	[7:4]	PO5	0000 = open-drain, 0001 = weak pullup to IN3, 0010 = weak pullup to IN4, 0011 = weak pullup to IN5, 0100 = weak pullup to IN6, 0101 = weak pullup to ABP, 0110 = push-pull to IN3, 0111 = push-pull to IN4, 1000 = push-pull to IN5, 1001 = push-pull to IN6, 1010 through 1111 = not used.
31h	8031h	[7:4]	PO6	
35h	8035h	[7:4]	PO7	
39h	8039h	[7:4]	PO8	

Table 24. Programmable Output Stage Options (MAX6871)

REGISTER ADDRESS	EEPROM MEMORY ADDRESS	BIT RANGE	AFFECTED OUTPUT	DESCRIPTION
1Ch	801Ch	[7:5]	PO1	000 = open-drain, 001 = weak pullup to IN3, 010 = weak pullup to IN4, 011–100 = not used, 101 = weak pullup to ABP, 110 = charge-pump output, 111 = not used.
23h	8023h	[7:5]	PO2	
2Ah	802Ah	[7:4]	PO3	0000 = open-drain, 0001 = weak pullup to IN3, 0010 = weak pullup to IN4, 0011–0100 = not used, 0101 = weak pullup to ABP, 0110 = push-pull to IN3, 0111 = push-pull to IN4, 1000–1111 = not used.
31h	8031h	[7:4]	PO4	
35h	8035h	[7:4]	PO5	

EEPROM-Programmable Hex/Quad Power-Supply Sequencers/Supervisors with ADC

MAX6870/MAX6871

Table 25. PO_ Timeout Periods

REGISTER ADDRESS	EEPROM MEMORY ADDRESS	BIT RANGE	AFFECTED OUTPUTS		DESCRIPTION
			MAX6870	MAX6871	
11h	8011h	[3:1]	PO1	—	000 = 25µs 001 = 1.5625ms 010 = 6.25ms 011 = 25ms 100 = 50ms 101 = 200ms 110 = 400ms 111 = 1600ms
15h	8015h	[3:1]	PO2	—	
1Ch	801Ch	[4:2]	PO3	PO1	
23h	8023h	[4:2]	PO4	PO2	
2Ah	802Ah	[3:1]	PO5	PO3	
31h	8031h	[3:1]	PO6	PO4	
35h	8035h	[3:1]	PO7	PO5	
39h	8039h	[3:1]	PO8	—	

Charge-Pump Output Configuration

Configure the programmable outputs of the MAX6870/MAX6871 as charge-pump outputs to drive n-channel FETs for power-supply sequencing applications. Only PO1–PO4 (MAX6870) or PO1 and PO2 (MAX6871) can be configured as charge-pump output stages. The charge-pump output high voltage is typically $V_{ABP} + 5.5V$ when unloaded.

Push-Pull Output Configuration

The MAX6870/MAX6871's programmable outputs sink 4mA and source 10mA when configured as push-pull outputs. Only PO5–PO8 (MAX6870), or PO3/PO4/PO5 (MAX6871) can be configured as push-pull output stages. The push-pull output stages refer to any of IN3–IN6 (MAX6870)/IN3/IN4 (MAX6871) as configured in Tables 23 and 24. Use the push-pull output configuration to drive loads with fast rise/fall times, or those with low impedance.

Weak Pullup Output Configuration

The MAX6870/MAX6871's programmable outputs sink 4mA when configured as weak pullups. The weak pullup of 10kΩ refers to any of IN3–IN6 (MAX6870)/IN3/IN4 (MAX6871) or ABP as configured in Tables 23 and 24. All programmable outputs of the MAX6870/MAX6871 may be configured as weak pullups.

Open-Drain Output Configuration

Connect an external pullup resistor from the programmable output to an external voltage when configured as an open-drain output. PO1–PO4 (PO1 and PO2 for the MAX6871) may be pulled up to +13.2V. PO5–PO8 (PO3/PO4/PO5 for the MAX6871) may be pulled up to a voltage less than or equal to ABP. Choose the pullup resistor depending on the number of devices connected to the open-drain output and the allowable current consumption. The open-drain output configuration

allows wire-ORed connections, and provides flexibility in setting the pullup current.

Configuring the MAX6870/MAX6871

The MAX6870/MAX6871 factory-default configuration sets all registers to 00h except 3Ah, which is set to FFh. Each device requires configuration before full power is applied to the system. To configure the MAX6870/MAX6871, first apply an input voltage to IN1 or one of IN3–IN6 (MAX6870)/IN3/IN4 (MAX6871) (see the *Powering the MAX6870/MAX6871* section). $V_{IN1} > +4V$ or one of $V_{IN3} - V_{IN6} > +2.7V$, to ensure device operation. Next, transmit data through the serial interface. Use the block write protocol to quickly configure the device. Write to the configuration registers first to ensure the device is configured properly. After completing the setup procedure, use the read word protocol to verify the data from the configuration registers. Lastly, use the write word protocol to write this data to the EEPROM registers. After completing EEPROM register configuration, apply full power to the system to begin normal operation. The non-volatile EEPROM stores the latest configuration upon removal of power. Write 0's to all EEPROM registers to clear the memory.

Software Reboot

A software reboot allows the user to restore the EEPROM configuration to the volatile registers without cycling the power supplies. Use the send byte command with data byte 88h to initiate a software reboot. The 3.5ms (max) power-up delay also applies after a software reboot.

SMBus/I²C-Compatible Serial Interface

The MAX6870/MAX6871 feature an I²C/SMBus-compatible serial interface consisting of a serial data line (SDA) and a serial clock line (SCL). SDA and SCL allow bidirectional communication between the MAX6870/MAX6871

EEPROM-Programmable Hex/Quad Power-Supply Sequencers/Supervisors with ADC

and the master device at clock rates up to 400kHz. Figure 2 shows the interface timing diagram. The MAX6870/MAX6871 are transmit/receive slave-only devices, relying upon a master device to generate a clock signal. The master device (typically a microcontroller) initiates data transfer on the bus and generates SCL to permit that transfer.

A master device communicates to the MAX6870/MAX6871 by transmitting the proper address followed by command and/or data words. Each transmit sequence is framed by a START (S) or REPEATED START (SR) condition and a STOP (P) condition. Each word transmitted over the bus is 8 bits long and is always followed by an acknowledge pulse.

SCL is a logic input, while SDA is a logic input/open-drain output. SCL and SDA both require external pullup

resistors to generate the logic-high voltage. Use 4.7kΩ for most applications.

Bit Transfer

Each clock pulse transfers one data bit. The data on SDA must remain stable while SCL is high (Figure 3), otherwise the MAX6870/MAX6871 register a START or STOP condition (Figure 4) from the master. SDA and SCL idle high when the bus is not busy.

Start and Stop Conditions

Both SCL and SDA idle high when the bus is not busy. A master device signals the beginning of a transmission with a START (S) condition (Figure 4) by transitioning SDA from high to low while SCL is high. The master device issues a STOP (P) condition (Figure 4) by transitioning SDA from low to high while SCL is high. A STOP

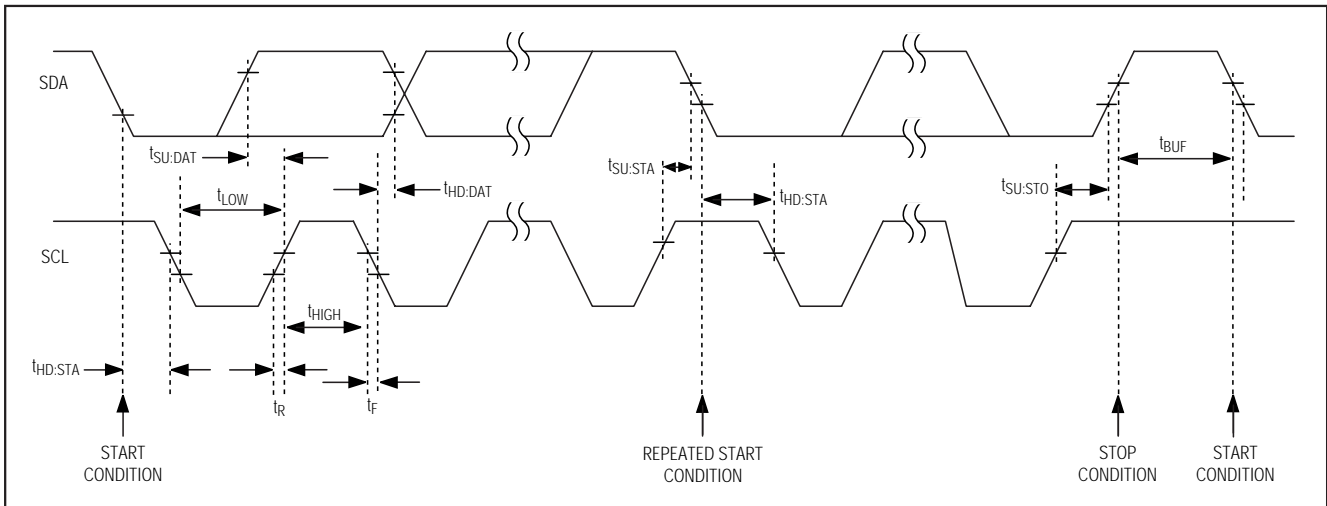

Figure 2. Serial-Interface Timing Details

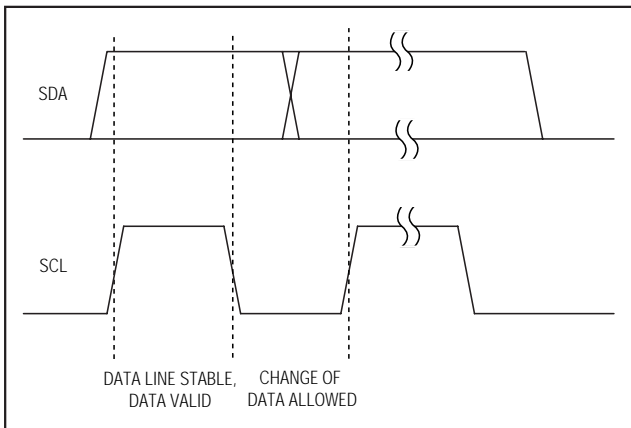

Figure 3. Bit Transfer

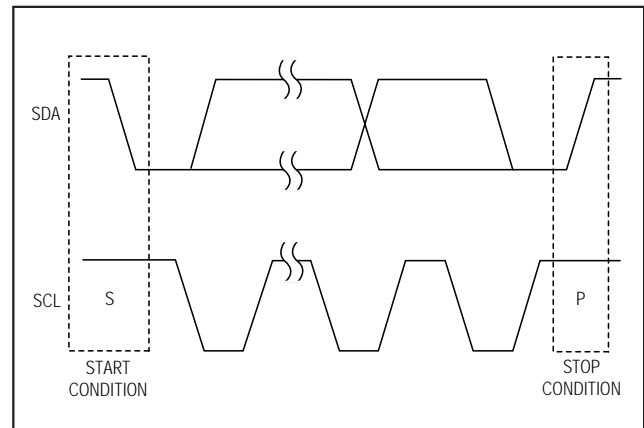

Figure 4. Start and Stop Conditions

EEPROM-Programmable Hex/Quad Power-Supply Sequencers/Supervisors with ADC

condition frees the bus for another transmission. The bus remains active if a REPEATED START condition is generated, such as in the block read protocol (see Figure 7).

Early STOP Conditions

The MAX6870/MAX6871 recognize a STOP condition at any point during transmission except if a STOP condition occurs in the same high pulse as a START condition. This condition is not a legal I²C format. At least one clock pulse must separate any START and STOP condition.

Repeated START Conditions

A REPEATED START (SR) condition may indicate a change of data direction on the bus. Such a change occurs when a command word is required to initiate a read operation (see Figure 7). SR may also be used when the bus master is writing to several I²C devices and does not want to relinquish control of the bus. The MAX6870/MAX6871 serial interface supports continuous write operations with or without an SR condition separating them. Continuous read operations require SR conditions because of the change in direction of data flow.

Acknowledge

The acknowledge bit (ACK) is the 9th bit attached to any 8-bit data word. The receiving device always generates

an ACK. The MAX6870/MAX6871 generate an ACK when receiving an address or data by pulling SDA low during the 9th clock period (Figure 5). When transmitting data, such as when the master device reads data back from the MAX6870/MAX6871, the MAX6870/MAX6871 wait for the master device to generate an ACK. Monitoring ACK allows for detection of unsuccessful data transfers. An unsuccessful data transfer occurs if the receiving device is busy or if a system fault has occurred. In the event of an unsuccessful data transfer, the bus master should reattempt communication at a later time. The MAX6870/MAX6871 generate a NACK after the slave address during a software reboot, while writing to the EEPROM, or when receiving an illegal memory address.

Slave Address

The MAX6870/MAX6871 slave address conforms to the following table:

SA7 (MSB)	SA6	SA5	SA4	SA3	SA2	SA1	SA0 (LSB)
1	0	1	0	A1	A0	X	R/W

X = Don't care.

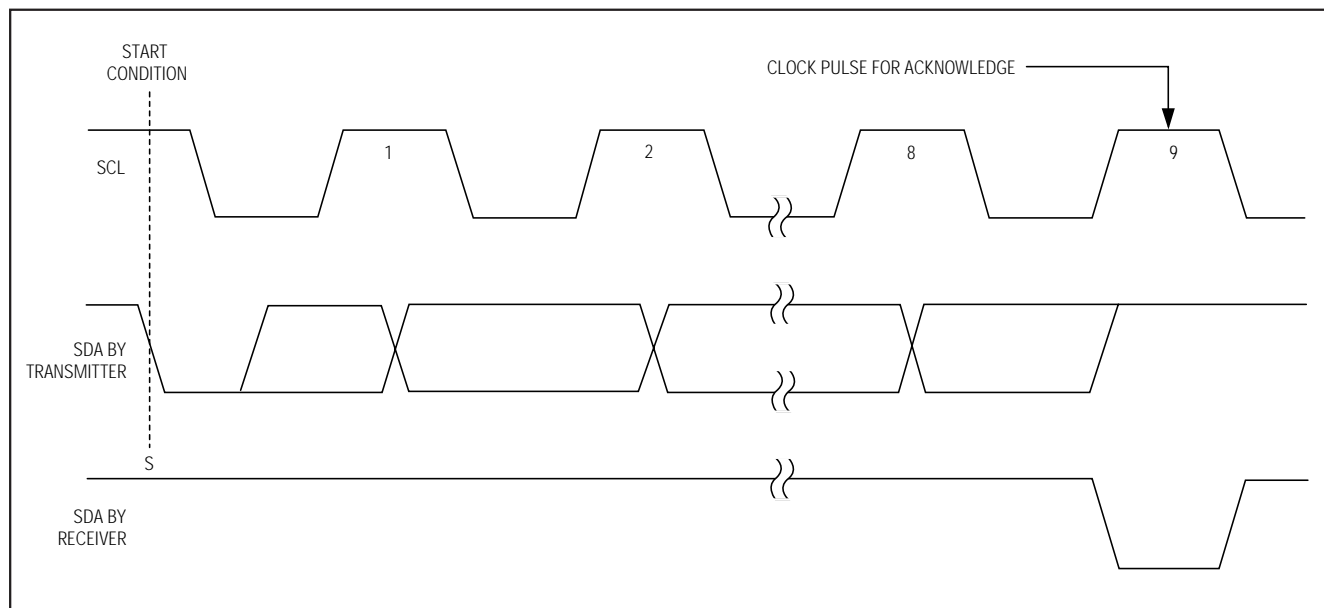

Figure 5. Acknowledge

EEPROM-Programmable Hex/Quad Power-Supply Sequencers/Supervisors with ADC

SA7 through SA4 represent the standard interface address (1010) for devices with EEPROM. SA3 and SA2 correspond to the A1 and A0 address inputs of the MAX6870/MAX6871 (hard-wired as logic-low or logic-high). SA0 is a read/write flag bit (0 = write, 1 = read).

The A0 and A1 address inputs allow up to four MAX6870/MAX6871 devices to connect to one bus. Connect A0 and A1 to GND or to the serial interface power supply (see Figure 6).

Send Byte

The send byte protocol allows the master device to send one byte of data to the slave device (see Figure 7). The send byte presets a register pointer address for a subsequent read or write. The slave sends a NACK instead of an ACK if the master tries to send an address that is not allowed. If the master sends 80h, 81h, or 82h, the data is ACK. This could be start of the write byte/word protocol, and the slave expects at least one further data byte. If the master sends a stop condition, the internal address pointer does not change. If the master sends 84h, this signifies that the block read protocol is expected, and a repeated start condition should follow. The device reboots if the master sends 88h. The send byte procedure follows:

- 1) The master sends a start condition.
- 2) The master sends the 7-bit slave address and a write bit (low).
- 3) The addressed slave asserts an ACK on SDA.
- 4) The master sends an 8-bit data byte.
- 5) The addressed slave asserts an ACK on SDA.
- 6) The master sends a stop condition.

Write Byte/Word

The write byte/word protocol allows the master device to write a single byte in the register bank, preset an EEPROM (configuration or user) address for a subsequent read, or to write a single byte to the configuration or user EEPROM (see Figure 7). The write byte/word procedure follows:

- 1) The master sends a start condition.
- 2) The master sends the 7-bit slave address and a write bit (low).
- 3) The addressed slave asserts an ACK on SDA.
- 4) The master sends an 8-bit command code.
- 5) The addressed slave asserts an ACK on SDA.
- 6) The master sends an 8-bit data byte.
- 7) The addressed slave asserts an ACK on SDA.
- 8) The master sends a stop condition or sends another 8-bit data byte.
- 9) The addressed slave asserts an ACK on SDA.
- 10) The master sends a stop condition.

To write a single byte to the register bank, only the 8-bit command code and a single 8-bit data byte are sent. The command code must be in the range of 00h to 45h. The data byte is written to the register bank if the command code is valid. The slave generates a NACK at step 5 if the command code is invalid.

To preset an EEPROM (configuration or user) address for a subsequent read, the 8-bit command code and a single 8-bit data byte are sent. The command code must be 80h if the write is to be directed into the configuration EEPROM, or 81h or 82h, if the write is to be

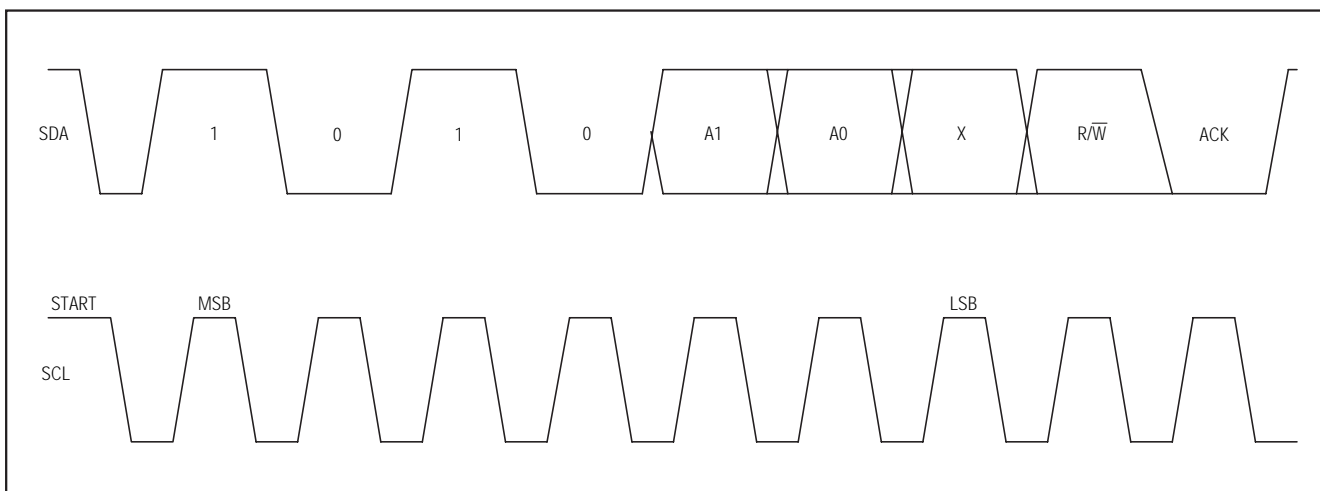

Figure 6. Slave Address

EEPROM-Programmable Hex/Quad Power-Supply Sequencers/Supervisors with ADC

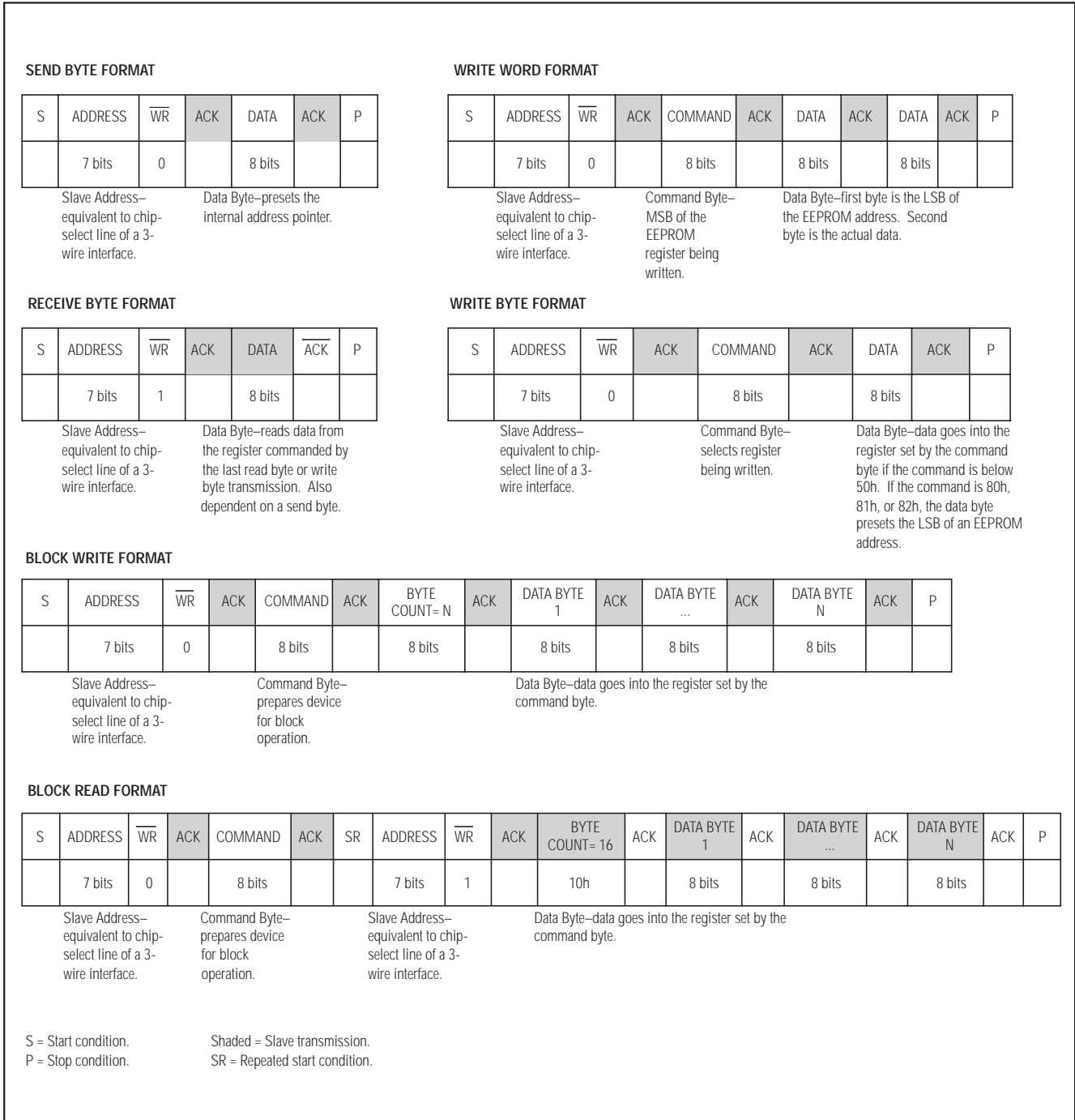

Figure 7. SMBus/I²C Protocols

EEPROM-Programmable Hex/Quad Power-Supply Sequencers/Supervisors with ADC

directed into the user EEPROM. If the command code is 80h, the data byte must be in the range of 00h to 45h. If the command code is 81h or 82h, the data byte can be 00h to FFh. A NACK is generated in step 7 if none of the above conditions are true.

To write a single byte of data to the user or configuration EEPROM, the 8-bit command code and a single 8-bit data byte are sent. The following 8-bit data byte is written to the addressed EEPROM location.

Block Write

The block write protocol allows the master device to write a block of data (1 to 16 bytes) to the EEPROM or to the register bank (see Figure 7). The destination address must already be set by the send byte or write byte protocol and the command code must be 83h. If the number of bytes to be written causes the address pointer to exceed 45h for the configuration register or configuration EEPROM, the address pointer stays at 45h, overwriting this memory address with the remaining bytes of data. The last data byte sent is stored at register address 45h. If the number of bytes to be written exceeds the address pointer FFh for the user EEPROM, the address pointer loops back to 00h, and continues writing bytes until all data is written. The block write procedure follows:

- 1) The master sends a start condition.
- 2) The master sends the 7-bit slave address and a write bit (low).
- 3) The addressed slave asserts an ACK on SDA.
- 4) The master sends the 8-bit command code for block write (83h).
- 5) The addressed slave asserts an ACK on SDA.
- 6) The master sends the 8-bit byte count (1 to 16 bytes) N.
- 7) The addressed slave asserts an ACK on SDA.
- 8) The master sends 8-bits of data.
- 9) The addressed slave asserts an ACK on SDA.
- 10) Repeat steps 8 and 9 one time.
- 11) The master generates a stop condition.

Receive Byte

The receive byte protocol allows the master device to read the register content of the MAX6870/MAX6871 (see Figure 7). The EEPROM or register address must be preset with a send byte or write word protocol first. Once the read is complete, the internal pointer increases by one. Repeating the receive byte protocol reads

the contents of the next address. The receive byte procedure follows:

- 1) The master sends a start condition.
- 2) The master sends the 7-bit slave address and a read bit (high).
- 3) The addressed slave asserts an ACK on SDA.
- 4) The slave sends 8 data bits.
- 5) The master asserts a NACK on SDA.
- 6) The master generates a stop condition.

Block Read

The block read protocol allows the master device to read a block of 16 bytes from the EEPROM or register bank (see Figure 7). Read fewer than 16 bytes of data by issuing an early STOP condition from the master, or by generating a NACK with the master. The send byte or write byte protocol predetermines the destination address with a command code of 84h. The block read procedure follows:

- 1) The master sends a start condition.
- 2) The master sends the 7-bit slave address and a write bit (low).
- 3) The addressed slave asserts an ACK on SDA.
- 4) The master sends 8 bits of the block read command (84h).
- 5) The slave asserts an ACK on SDA, unless busy.
- 6) The master generates a repeated start condition.
- 7) The master sends the 7-bit slave address and a read bit (high).
- 8) The slave asserts an ACK on SDA.
- 9) The slave sends the 8-bit byte count (16).
- 10) The master asserts an ACK on SDA.
- 11) The slave sends 8 bits of data.
- 12) The master asserts an ACK on SDA.
- 13) Repeat steps 8 and 9 fifteen times.
- 14) The master generates a stop condition.

Address Pointers

Use the send byte protocol to set the register address pointers before read and write operations. For the configuration registers, valid address pointers range from 00h to 45h. Register addresses outside of this range result in a NACK being issued from the MAX6870/MAX6871. When using the block write protocol, the

EEPROM-Programmable Hex/Quad Power-Supply Sequencers/Supervisors with ADC

MAX6870/MAX6871

address pointer automatically increments after each data byte, except when the address pointer is already at 45h. If the address pointer is already 45h, and more data bytes are being sent, these subsequent bytes overwrite address 45h repeatedly, leaving only the last data byte sent stored at this register address.

For the configuration EEPROM, valid address pointers range from 8000h to 8045h. Registers 8046h to 804Fh are reserved and should not be overwritten. Register addresses from 8050h to 80FFh return a NACK from the MAX6870/MAX6871. When using the block write protocol, the address pointer automatically increments after each data byte, except when the address pointer is already at 8045h. If the address pointer is already 8045h, and more data bytes are being sent, these subsequent bytes overwrite address 8045h repeatedly, leaving only the last data byte sent stored at this register address.

For the user EEPROM, valid address pointers range from 8100h to 81FFh and 8200h to 82FFh. Block write and block read protocols allow the address pointer to reset (to 8100h or 8200h) when attempting to write or read beyond 81FFh or 82FFh.

Configuration EEPROM

The configuration EEPROM addresses range from 8000h to 8045h. Write data to the configuration EEPROM to automatically set up the MAX6870/MAX6871 upon power-up. Data transfers from the configuration EEPROM to the configuration registers when ABP exceeds UVLO during power-up or after a software reboot. After ABP exceeds UVLO, an internal 1MHz clock starts after a 5µs delay, and data transfer begins. Data transfer disables access

to the configuration registers and EEPROM. The data transfer from EEPROM to configuration registers takes 3.5ms (max). Read configuration EEPROM data at any time after power-up or software reboot. Write commands to the configuration EEPROM are allowed at any time after power-up or software reboot, unless the configuration lock bit is set (see Table 30). The maximum cycle time to write a single byte is 11ms (max).

User EEPROM

The 512 byte user EEPROM addresses range from 8100h to 82FFh (see Figure 8). Store software-revision data, board-revision data, and other data in these registers. The maximum cycle time to write a single byte is 11ms (max).

Configuration Register Bank and EEPROM

The configuration registers can be directly modified by the serial interface without modifying the EEPROM after the power-up procedure terminates and the configuration EEPROM data has been loaded into the configuration register bank. Use the write byte or block write protocols to write directly to the configuration registers. Changes to the configuration registers take effect immediately and are lost upon power removal.

At device power-up, the register bank loads configuration data from the EEPROM. Configuration data may be directly altered in the register bank during application development, allowing maximum flexibility. Transfer the new configuration data, byte by byte, to the configuration EEPROM with the write byte protocol. The next device power-up or software reboot automatically loads the new configuration.

Table 26. Register Map

REGISTER ADDRESS	EEPROM MEMORY ADDRESS	READ/ WRITE	DESCRIPTION
00h	8000h	R/W	IN1 primary undervoltage detector threshold (Table 2).
01h	8001h	R/W	IN2 primary undervoltage detector threshold (Table 3).
02h	8002h	R/W	IN3 primary undervoltage detector threshold (Table 4).
03h	8003h	R/W	IN4 primary undervoltage detector threshold (Table 4).
04h	8004h	R/W	IN5 primary undervoltage detector threshold (MAX6870 only) (Table 4).
05h	8005h	R/W	IN6 primary undervoltage detector threshold (MAX6870 only) (Table 4).
06h	8006h	R/W	IN1 secondary undervoltage/overvoltage detector threshold (Table 2).
07h	8007h	R/W	IN2 secondary undervoltage/overvoltage detector threshold (Table 3).
08h	8008h	R/W	IN3 secondary undervoltage/overvoltage detector threshold (Table 4).
09h	8009h	R/W	IN4 secondary undervoltage/overvoltage detector threshold (Table 4).
0Ah	800Ah	R/W	IN5 secondary undervoltage/overvoltage detector threshold (MAX6870 only) (Table 4).

EEPROM-Programmable Hex/Quad Power-Supply Sequencers/Supervisors with ADC

MAX6870/MAX6871

Table 26. Register Map (continued)

REGISTER ADDRESS	EEPROM MEMORY ADDRESS	READ/ WRITE	DESCRIPTION
0Bh	800Bh	R/W	IN6 secondary undervoltage/overvoltage detector threshold (MAX6870 only) (Table 4).
0Ch	800Ch	R/W	Secondary undervoltage/overvoltage selection (Tables 2, 4).
0Dh	800Dh	R/W	Threshold range selection (Tables 2–4).
0Eh	800Eh	R/W	PO1 (MAX6870 only) input selection (Table 10).
0Fh	800Fh	R/W	PO1 (MAX6870 only) input selection (Table 10).
10h	8010h	R/W	PO1 (MAX6870 only) input selection (Table 10).
11h	8011h	R/W	PO1 (MAX6870 only) input selection, PO_ timeout period, and output type selection (Tables 10, 23, and 25).
12h	8012h	R/W	PO2 (MAX6870 only) input selection (Table 11).
13h	8013h	R/W	PO2 (MAX6870 only) input selection (Table 11).
14h	8014h	R/W	PO2 (MAX6870 only) input selection (Table 11).
15h	8015h	R/W	PO2 (MAX6870 only) input selection, PO_ timeout period, and output type selection (Tables 11, 23, and 25).
16h	8016h	R/W	PO3 (MAX6870)/PO1 (MAX6871) input selection—Product 1 (Table 12).
17h	8017h	R/W	PO3 (MAX6870)/PO1 (MAX6871) input selection—Product 1 (Table 12).
18h	8018h	R/W	PO3 (MAX6870)/PO1 (MAX6871) input selection—Product 1 (Table 12).
19h	8019h	R/W	PO3 (MAX6870)/PO1 (MAX6871) input selection—Product 2 (Table 13).
1Ah	801Ah	R/W	PO3 (MAX6870)/PO1 (MAX6871) input selection—Product 2 (Table 13).
1Bh	801Bh	R/W	PO3 (MAX6870)/PO1 (MAX6871) input selection—Product 2 (Table 13).
1Ch	801Ch	R/W	PO3 (MAX6870)/PO1 (MAX6871) input selection—Products 1 and 2, PO_ timeout period, and output type selection (Tables 12, 13, 23, 24, and 25).
1Dh	801Dh	R/W	PO4 (MAX6870)/PO2 (MAX6871) input selection—Product 1 (Table 14).
1Eh	801Eh	R/W	PO4 (MAX6870)/PO2 (MAX6871) input selection—Product 1 (Table 14).
1Fh	801Fh	R/W	PO4 (MAX6870)/PO2 (MAX6871) input selection—Product 1 (Table 14).
20h	8020h	R/W	PO4 (MAX6870)/PO2 (MAX6871) input selection—Product 2 (Table 15).
21h	8021h	R/W	PO4 (MAX6870)/PO2 (MAX6871) input selection—Product 2 (Table 15).
22h	8022h	R/W	PO4 (MAX6870)/PO2 (MAX6871) input selection—Product 2 (Table 15).
23h	8023h	R/W	PO4 (MAX6870)/PO2 (MAX6871) input selection—Products 1 and 2, PO_ timeout period, and output type selection (Tables 14, 15, 23, 24, and 25).
24h	8024h	R/W	PO5 (MAX6870)/PO3 (MAX6871) input selection—Product 1 (Table 16).
25h	8025h	R/W	PO5 (MAX6870)/PO3 (MAX6871) input selection—Product 1 (Table 16).
26h	8026h	R/W	PO5 (MAX6870)/PO3 (MAX6871) input selection—Product 1 (Table 16).
27h	8027h	R/W	PO5 (MAX6870)/PO3 (MAX6871) input selection—Product 2 (Table 17).
28h	8028h	R/W	PO5 (MAX6870)/PO3 (MAX6871) input selection—Product 2 (Table 17).
29h	8029h	R/W	PO5 (MAX6870)/PO3 (MAX6871) input selection—Product 2 (Table 17).
2Ah	802Ah	R/W	PO5 (MAX6870)/PO3 (MAX6871) input selection—Products 1 and 2, PO_ timeout period, and output type selection (Tables 16, 23, 24, and 25).
2Bh	802Bh	R/W	PO6 (MAX6870)/PO4 (MAX6871) input selection—Product 1 (Table 18).
2Ch	802Ch	R/W	PO6 (MAX6870)/PO4 (MAX6871) input selection—Product 1 (Table 18).

EEPROM-Programmable Hex/Quad Power-Supply Sequencers/Supervisors with ADC

MAX6870/MAX6871

Table 26. Register Map (continued)

REGISTER ADDRESS	EEPROM MEMORY ADDRESS	READ/ WRITE	DESCRIPTION
2Dh	802Dh	R/W	PO6 (MAX6870)/PO4 (MAX6871) input selection—Product 1 (Table 18).
2Eh	802Eh	R/W	PO6 (MAX6870)/PO4 (MAX6871) input selection—Product 2 (Table 19).
2Fh	802Fh	R/W	PO6 (MAX6870)/PO4 (MAX6871) input selection—Product 2 (Table 19).
30h	8030h	R/W	PO6 (MAX6870)/PO4 (MAX6871) input selection—Product 2 (Table 19).
31h	8031h	R/W	PO6 (MAX6870)/PO4 (MAX6871) input selection—Products 1 and 2, reset timeout period, and output type selection (Tables 18, 23, 24, and 25).
32h	8032h	R/W	PO7 (MAX6870)/PO5 (MAX6871) input selection (Table 20).
33h	8033h	R/W	PO7 (MAX6870)/PO5 (MAX6871) input selection (Table 20).
34h	8034h	R/W	PO7 (MAX6870)/PO5 (MAX6871) input selection (Table 20).
35h	8035h	R/W	PO7 (MAX6870)/PO5 (MAX6871) input selection, PO_ timeout period, and output type selection (Tables 20, 23, 24, and 25).
36h	8036h	R/W	PO8 (MAX6870 only) input selection (Table 21).
37h	8037h	R/W	PO8 (MAX6870 only) input selection (Table 21).
38h	8038h	R/W	PO8 (MAX6870 only) input selection (Table 21).
39h	8039h	R/W	PO8 (MAX6870 only) input selection, PO_ timeout period, and output type selection. (Tables 21, 23, 24, and 25).
3Ah	803Ah	R/W	Programmable output polarity (active-high/active-low) (Table 22).
3Bh	803Bh	R/W	GPI_ input polarity, PO5, PO6 (Tables 6, 17, and 19).
3Ch	803Ch	R/W	WDI1 input selection and timeout enable (Table 27).
3Dh	803Dh	R/W	WDI1 initial and normal timeout duration (Table 28).
3Eh	803Eh	R/W	WDI2 input selection and timeout enable (Table 27).
3Fh	803Fh	R/W	WDI2 initial and normal timeout duration (Table 28).
40h	8040h	R/W	\overline{MR} input and programmable output behavior (Table 7).
41h	8041h	R/W	\overline{MARGIN} and programmable output behavior (Table 8).
42h	8042h	R/W	Programmable output state with \overline{MARGIN} assertion (Table 8).
43h	8043h	R/W	User EEPROM write disable (Table 31).
44h	8044h	R/W	Internal/external reference selection (Table 9).
45h	8045h	R/W	Configuration lock (Table 30).
46h	8046h	—	Reserved. Should not be overwritten.
47h	8047h	—	Reserved. Should not be overwritten.
48h	8048h	—	Reserved. Should not be overwritten.
49h	8049h	—	Reserved. Should not be overwritten.
4Ah	804Ah	—	Reserved. Should not be overwritten.
4Bh	804Bh	—	Reserved. Should not be overwritten.
4Ch	804Ch	—	Reserved. Should not be overwritten.
4Dh	804Dh	—	Reserved. Should not be overwritten.
4Eh	804Eh	—	Reserved. Should not be overwritten.
4Fh	804Fh	—	Reserved. Should not be overwritten.

EEPROM-Programmable Hex/Quad Power-Supply Sequencers/Supervisors with ADC

Table 26. Register Map (continued)

REGISTER ADDRESS	EEPROM MEMORY ADDRESS	READ/ WRITE	DESCRIPTION
50h	—	R	ADC data for IN1 (8 MSBs).
51h	—	R	ADC data for IN1 (2 LSBs).
52h	—	R	ADC data for IN2 (8 MSBs).
53h	—	R	ADC data for IN2 (2 LSBs).
54h	—	R	ADC data for IN3 (8 MSBs).
55h	—	R	ADC data for IN3 (2 LSBs).
56h	—	R	ADC data for IN4 (8 MSBs).
57h	—	R	ADC data for IN4 (2 LSBs).
58h	—	R	ADC data for IN5 (8 MSBs, MAX6870 only).
59h	—	R	ADC data for IN5 (2 LSBs, MAX6870 only).
5Ah	—	R	ADC data for IN6 (8 MSBs, MAX6870 only).
5Bh	—	R	ADC data for IN6 (2 LSBs, MAX6870 only).
5Ch	—	R	ADC data for AUXIN1 (8 MSBs) (Table 5).
5Dh	—	R	ADC data for AUXIN1 (2 LSBs) (Table 5).
5Eh	—	R	ADC data for AUXIN2 (8 MSBs) (Table 5).
5Fh	—	R	ADC data for AUXIN2 (2 LSBs) (Table 5).
60h	—	R	Fault flags for IN1–IN6 (primary thresholds) (Table 29).
61h	—	R	Fault flags for IN1–IN6 (secondary thresholds) (Table 29).
62h	—	R	Fault flags for WDI _L , GPI _L , and \overline{MR} (Table 29).

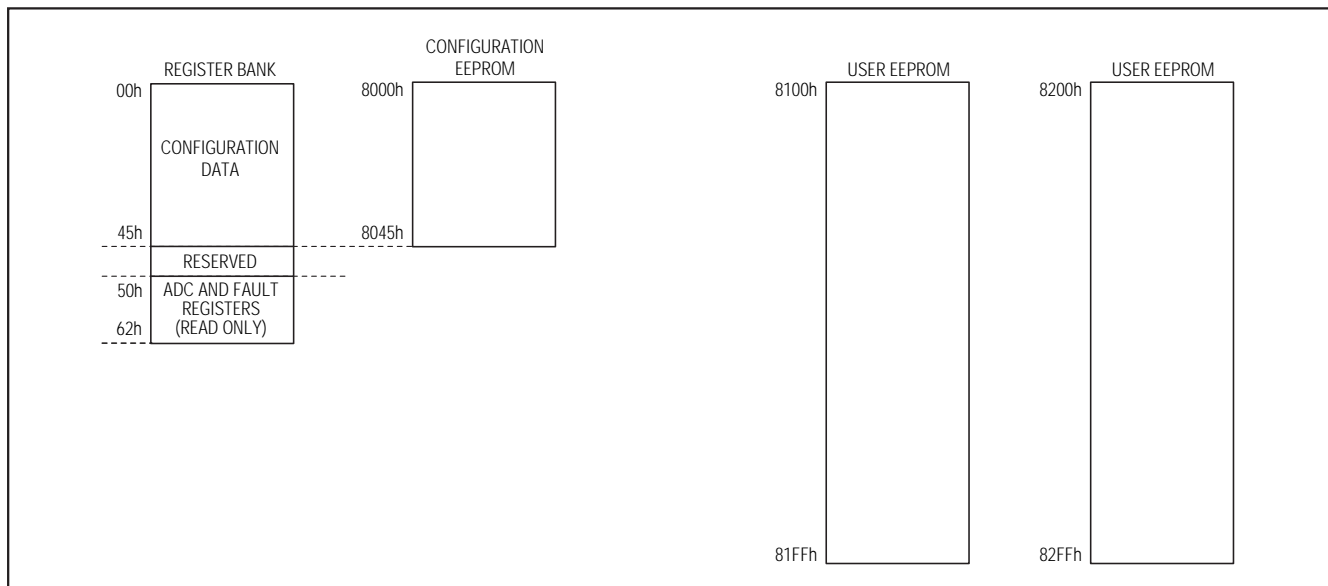

Figure 8. Memory Map

EEPROM-Programmable Hex/Quad Power-Supply Sequencers/Supervisors with ADC

MAX6870/MAX6871

Configuring the Watchdog Timers (Registers 3Ch–3Fh)

A watchdog timer monitors microprocessor (μ P) software execution for a stalled condition and resets the μ P if it stalls. The output of a watchdog timer (one of the programmable outputs) connects to the reset input or a nonmaskable interrupt of the μ P.

Registers 3Ch–3Fh configure the watchdog functionality of the MAX6870/MAX6871. Program each watchdog timer to assert one or more programmable outputs (see Tables 10–21). Program each watchdog timer to reset on one of the GPI_ inputs, one of the programmable outputs, or a combination of one GPI_ input and one programmable output.

Each watchdog timer features independent initial and normal watchdog timeout periods. The initial watchdog timeout period applies immediately after power-up, after a reset event takes place, or after enabling the watchdog timer. The initial watchdog timeout period allows the μ P to

perform its initialization process. If no pulse occurs during the initial watchdog timeout period, the μ P is taking too long to initialize, indicating a potential problem.

The normal watchdog timeout period applies in every other cycle after the initial watchdog timeout period occurs. The normal watchdog timeout period monitors a pulsed output of the μ P that indicates when normal processor behavior occurs. If no pulse occurs during the normal watchdog timeout period, this indicates that the processor has stopped operating or is stuck in an infinite execution loop.

Disable or enable each initial timeout period through registers 3Ch and 3Eh. Registers 3Dh and 3Fh program the initial and normal watchdog timeout periods, and enable or disable each watchdog timer. See Tables 27 and 28 for a summary of the watchdog behavior.

Fault Detector

Registers 60h–62h store all fault conditions, including undervoltage, overvoltage, GPI_, and watchdog timer faults (see Table 29). Fault registers are read-only and lose contents upon power removal. The first read command from the fault registers after power-up gives invalid data. Any MR assertion writes to the fault register. Reading the fault register clears all fault flags. Both GPI_

Table 27. Watchdog Inputs (Addresses 3Ch (Watchdog 1), 3Eh (Watchdog 2))

BIT	NAME	DESCRIPTION
[1:0]	Watchdog Input Selection	00 = GPI1 input 01 = GPI2 input 10 = GPI3 input 11 = GPI4 input
[4:2]	Watchdog Internal Input Selection	000 = PO1 (MAX6870), not used (MAX6871) 001 = PO2 (MAX6870), not used (MAX6871) 010 = PO3 (MAX6870), PO1 (MAX6871) 011 = PO4 (MAX6870), PO2 (MAX6871) 100 = PO5 (MAX6870), PO3 (MAX6871) 101 = PO6 (MAX6870), PO4 (MAX6871) 110 = PO7 (MAX6870), PO5 (MAX6871) 111 = PO8 (MAX6870), not used (MAX6871)
[6:5]	Watchdog Dependency on Inputs	00 = 11 = watchdog clear depends on both GPI_ from 3Ch[1:0] and PO_ from 3Ch[4:2]. 01 = watchdog clear depends only on PO_ from 3Ch[4:2]. 10 = watchdog clear depends only on GPI_ from 3Ch[1:0].
[7]	Initial Watchdog Timeout Enable	0 = disables initial watchdog timeout period (normal watchdog timeout not affected). 1 = enables initial watchdog timeout period.

Table 28. Watchdog Timeout Period Selection (Addresses 3Dh (Watchdog 1), 3Fh (Watchdog 2))

BIT	NAME	DESCRIPTION
[2:0]	Normal Watchdog Timeout Period	000 = 6.25ms 001 = 25ms 010 = 100ms 011 = 400ms 100 = 1.6s 101 = 6.4s 110 = 25.6s 111 = 102.4s
[5:3]	Initial Watchdog Timeout Period (Immediately following power-up, reset event, or enabling watchdog)	000 = 6.25ms 001 = 25ms 010 = 100ms 011 = 400ms 100 = 1.6s 101 = 6.4s 110 = 25.6s 111 = 102.4s
[6]	Watchdog Enable	0 = disables watchdog timer 1 = enables watchdog timer
[7]	—	Not used

EEPROM-Programmable Hex/Quad Power-Supply Sequencers/Supervisors with ADC

MAX6870/MAX6871

Table 29. Fault Registers (60h–62h)

REGISTER ADDRESS	BIT RANGE	DESCRIPTION
60h	[0]	1 = IN1 falls below primary undervoltage threshold.
	[1]	1 = IN2 falls below primary undervoltage threshold.
	[2]	1 = IN3 falls below primary undervoltage threshold.
	[3]	1 = IN4 falls below primary undervoltage threshold.
	[4]	1 = IN5 (MAX6870 only) falls below primary undervoltage threshold.
	[5]	1 = IN6 (MAX6870 only) falls below primary undervoltage threshold.
	[7:6]	Not used.
61h	[0]	1 = IN1 falls below secondary undervoltage threshold or rises above secondary overvoltage threshold, depending on the settings in register 0Ch (see Tables 2, 3, and 4).
	[1]	1 = IN2 falls below secondary undervoltage threshold or rises above secondary overvoltage threshold, depending on the settings in register 0Ch (see Tables 2, 3, and 4).
	[2]	1 = IN3 falls below secondary undervoltage threshold or rises above secondary overvoltage threshold, depending on the settings in register 0Ch (see Tables 2, 3, and 4).
	[3]	1 = IN4 falls below secondary undervoltage threshold or rises above secondary overvoltage threshold, depending on the settings in register 0Ch (see Tables 2, 3, and 4).
	[4]	1 = IN5 (MAX6870 only) falls below secondary undervoltage threshold or rises above secondary overvoltage threshold, depending on the settings in register 0Ch (see Tables 2, 3, and 4).
	[5]	1 = IN6 (MAX6870 only) falls below secondary undervoltage threshold or rises above secondary overvoltage threshold, depending on the settings in register 0Ch (see Tables 2, 3, and 4).
	[7:6]	Not used.
62h	[0]	1 = WDI1 asserted.
	[1]	1 = WDI2 asserted.
	[2]	1 = GPI1 asserted.
	[3]	1 = GPI2 asserted.
	[4]	1 = GPI3 asserted.
	[5]	1 = GPI4 asserted.
	[6]	1 = \overline{MR} asserted.
	[7]	Not used.

and WDI_ bits assert if any of the GPI_ inputs are configured as watchdog inputs (WDI_) and a watchdog fault occurs.

Configuration Lock

Lock the configuration register bank and configuration EEPROM contents after initial programming by setting the lock bit high (see Table 30). Locking the configuration prevents write operations to all registers except the configuration lock register. Clear the lock bit to reconfigure the device.

Write Disable

A unique write disable feature protects the MAX6870/MAX6871 from inadvertent user EEPROM writes. As input voltages that power the serial interface, a μ P, or any other writing devices fall, unintentional data may be written onto the data bus. The user EEPROM write disable function (see Table 31) ensures that unintentional data does not corrupt the MAX6870/MAX6871 EEPROM data.

EEPROM-Programmable Hex/Quad Power-Supply Sequencers/Supervisors with ADC

MAX6870/MAX6871

Table 30. Configuration Lock Register

REGISTER ADDRESS	EEPROM MEMORY ADDRESS	BIT RANGE	DESCRIPTION
45h	8045h	[0]	0 = configuration unlocked. 1 = configuration locked.
		[7:1]	Not used.

Table 31. Write Disable Register

REGISTER ADDRESS	EEPROM MEMORY ADDRESS	BIT RANGE	DESCRIPTION
43h	8043h	[0]	0 = write not disabled if PO1 asserts (MAX6870). 1 = write disabled if PO1 asserts (MAX6870). Set to 0 (MAX6871).
		[1]	0 = write not disabled if PO2 asserts (MAX6870). 1 = write disabled if PO2 asserts (MAX6870). Set to 0 (MAX6871).
		[2]	0 = write not disabled if PO3 (MAX6870)/PO1 (MAX6871) asserts. 1 = write disabled if PO3 (MAX6870)/PO1 (MAX6871) asserts.
		[3]	0 = write not disabled if PO4 (MAX6870)/PO2 (MAX6871) asserts. 1 = write disabled if PO4 (MAX6870)/PO2 (MAX6871) asserts.
		[4]	0 = write not disabled if PO5 (MAX6870)/PO3 (MAX6871) asserts. 1 = write disabled if PO5 (MAX6870)/PO3 (MAX6871) asserts.
		[5]	0 = write not disabled if PO6 (MAX6870)/PO4 (MAX6871) asserts. 1 = write disabled if PO6 (MAX6870)/PO4 (MAX6871) asserts.
		[6]	0 = write not disabled if PO7 (MAX6870)/PO5 (MAX6871) asserts. 1 = write disabled if PO7 (MAX6870)/PO5 (MAX6871) asserts.
		[7]	0 = write not disabled if PO8 asserts (MAX6870). 1 = write disabled if PO8 asserts (MAX6870). Set to 0 (MAX6871).

Applications Information

Configuration Download at Power-up

The configuration of the MAX6870/MAX6871 (undervoltage/overvoltage thresholds, PO_ timeout periods, watchdog behavior, programmable output conditions and configurations, etc.) depends on the contents of the EEPROM. The EEPROM is comprised of buffered latches that store the configuration. The local volatile memory latches lose their contents at power-down. Therefore, at power-up, the device configuration must be restored by downloading the contents of the EEPROM (non-volatile memory) to the local latches. This download occurs in a number of steps:

- 1) Programmable outputs go high impedance with no power applied to the device.
- 2) When ABP exceeds +1V, all programmable outputs are weakly pulled to GND through a 10µA current sink.
- 3) When ABP exceeds UVLO, the configuration EEPROM starts to download its contents to the volatile configuration registers. The programmable outputs assume their programmed conditional output state when download is complete.
- 4) Any attempt to communicate with the device prior to this download completion results in a NACK being issued from the MAX6870/MAX6871.

EEPROM-Programmable Hex/Quad Power-Supply Sequencers/Supervisors with ADC

Forcing Programmable Outputs High During Power-Up

A weak 10 μ A pulldown holds all programmable outputs low during power-up until ABP exceeds the undervoltage lockout (UVLO) threshold. Applications requiring a guaranteed high programmable output for ABP down to GND require external pullup resistors to maintain the logic state until ABP exceeds UVLO. Use 20k Ω resistors for most applications.

Driving High-Side MOSFET Switches with the MAX6870/MAX6871

High-side MOSFET switches are commonly used in power-supply sequencing applications. First, configure the programmable output of the MAX6870/MAX6871 as an active-low charge-pump output and set the conditions to assert this output. Connect the programmable output to the gate of an n-channel MOSFET. As the conditions to deassert this output are met, the output deasserts high ($V_{ABP} + 5V$), turning on the FET, thus allowing the voltage on the drain to pass through to the downstream device (see Figure 9).

Uses for General-Purpose Inputs (GPI1–GPI4)

Watchdog Timer

Program GPI₁ as an input to one of the watchdog timers in the MAX6870/MAX6871. The GPI₁ input must toggle within the watchdog timeout period, otherwise any programmable output dependent on the watchdog timer asserts.

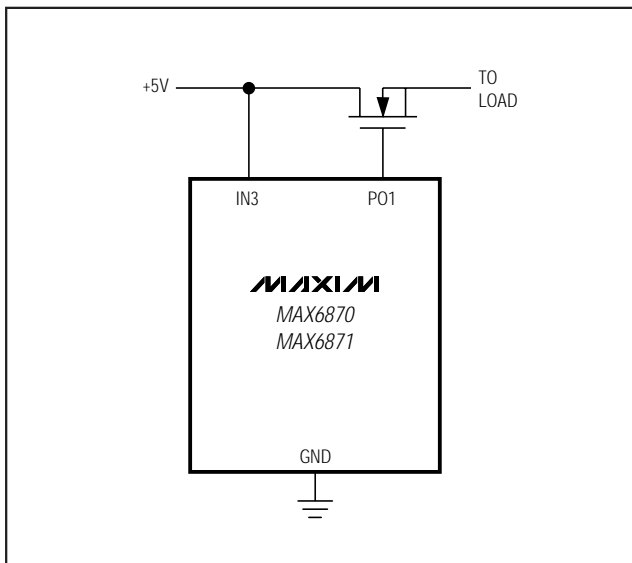

Figure 9. Driving High-Side n-Channel MOSFET Switches

Additional Manual Reset Functions

The PO7 (MAX6870)/PO5 (MAX6871) programmable outputs allow a single set (Product 1 only) of conditions to assert the output. Program the set of conditions to depend on one of the GPI₁ inputs. Any output that depends on GPI₁ asserts when GPI₁ is held in its active state, effectively acting as a manual reset input.

Other Fault Signals from μ C

Connect a general purpose output from a μ C to one of the GPI₁ inputs to allow interrupts to assert any output of the MAX6870/MAX6871. Configure one of the programmable outputs to assert on whichever GPI₁ input connects to the general purpose output of the μ C.

Uses for AUXIN1 and AUXIN2

Analog Output of Current-Sense Amplifier

Figure 10 shows the MAX6870/MAX6871 in a current-sensing application with the MAX4374. The MAX4374 generates an analog output voltage (OUT) proportional to the voltage difference between RS₊ and RS₋ and a latched comparator output (COUT) indicating an overcurrent condition. Connect OUT to AUXIN1 to provide continuous monitoring of the load current on the 12V supply. The internal ADC of the MAX6870/MAX6871 digitizes V_{OUT} and stores the results in read-only registers 5Ch through 5Fh. COUT latches high for $V_{CIN} > 600mV$, and clears with the RESET input of the MAX4374. Configure GPI1 as an active-high input and configure PO7 (MAX6870)/PO5 (MAX6871) to depend on GPI1. PO7/PO5 asserts to its active state when an overcurrent condition exists.

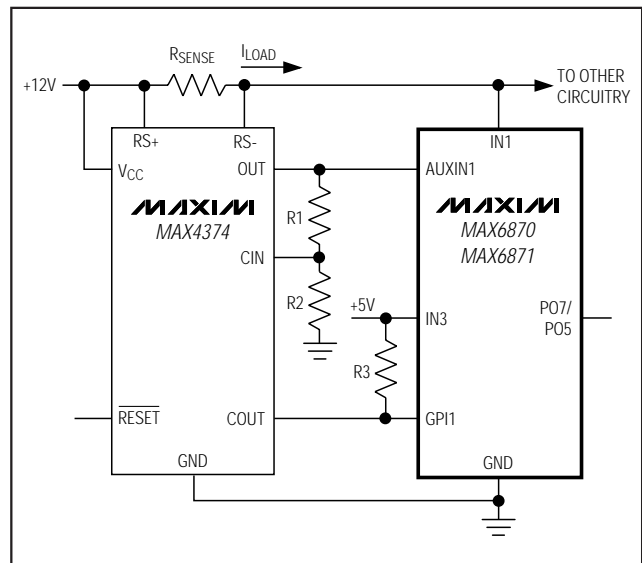

Figure 10. Monitoring Current-Sense Amplifier Outputs

EEPROM-Programmable Hex/Quad Power-Supply Sequencers/Supervisors with ADC

MAX6870/MAX6871

Temperature Sensor Outputs

Figure 11 shows the MAX6870/MAX6871 in a temperature-sensing application with the DS600. The DS600 generates an analog output voltage proportional to the sensed temperature through V_{OUT} and logic outputs on \overline{TO} and \overline{TO} (only \overline{TO} is shown). The internal ADC of the MAX6870/MAX6871 digitizes the analog output voltage of the DS600 and stores the results in read-only registers 5Ch through 5Fh. V_{TH} sets the threshold voltage that V_{OUT} must exceed for \overline{TO} to generate a logic-high signal. V_{TH} must be less than 1.25V, otherwise the overcurrent condition will occur after the internal ADC attains its full-scale input voltage. Configure GPI1 as an active-high input and configure PO7 (MAX6870)/PO5 (MAX6871) to depend on GPI1. When V_{OUT} increases above V_{TH} , \overline{TO} asserts high, causing PO7/PO5 to assert to its active state.

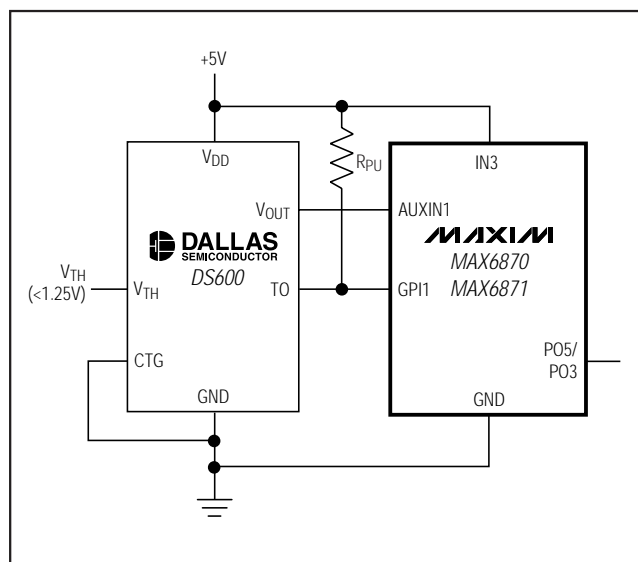

Figure 11. Temperature Sensor Outputs

Monitoring Other Voltages

Use AUXIN_ to monitor any voltage up to 1.25V. The internal ADC of the MAX6870/MAX6871 digitizes the voltage and stores the results in read-only registers 5Ch through 5Fh. The internal ADC cycles through the voltage monitor inputs and the auxiliary inputs every 200ms.

Layout and Bypassing

For better noise immunity, bypass each of the voltage detector inputs to GND with 0.1 μ F capacitors installed as close to the device as possible. Bypass ABP and DBP to GND with 1 μ F capacitors installed as close to the device as possible. ABP and DBP are internally generated voltages and should not be used to supply power to external circuitry.

Configuration Latency Period

A delay of less than 5 μ s occurs between writing to the configuration registers and the time when these changes actually take place, except when changing one of the voltage-detector thresholds. Changing a voltage-detector threshold typically takes 150 μ s. When changing EEPROM contents, a software reboot or cycling of power is required for these changes to transfer to volatile memory.

Chip Information

PROCESS: BiCMOS

EEPROM-Programmable Hex/Quad Power-Supply Sequencers/Supervisors with ADC

Pin Configurations

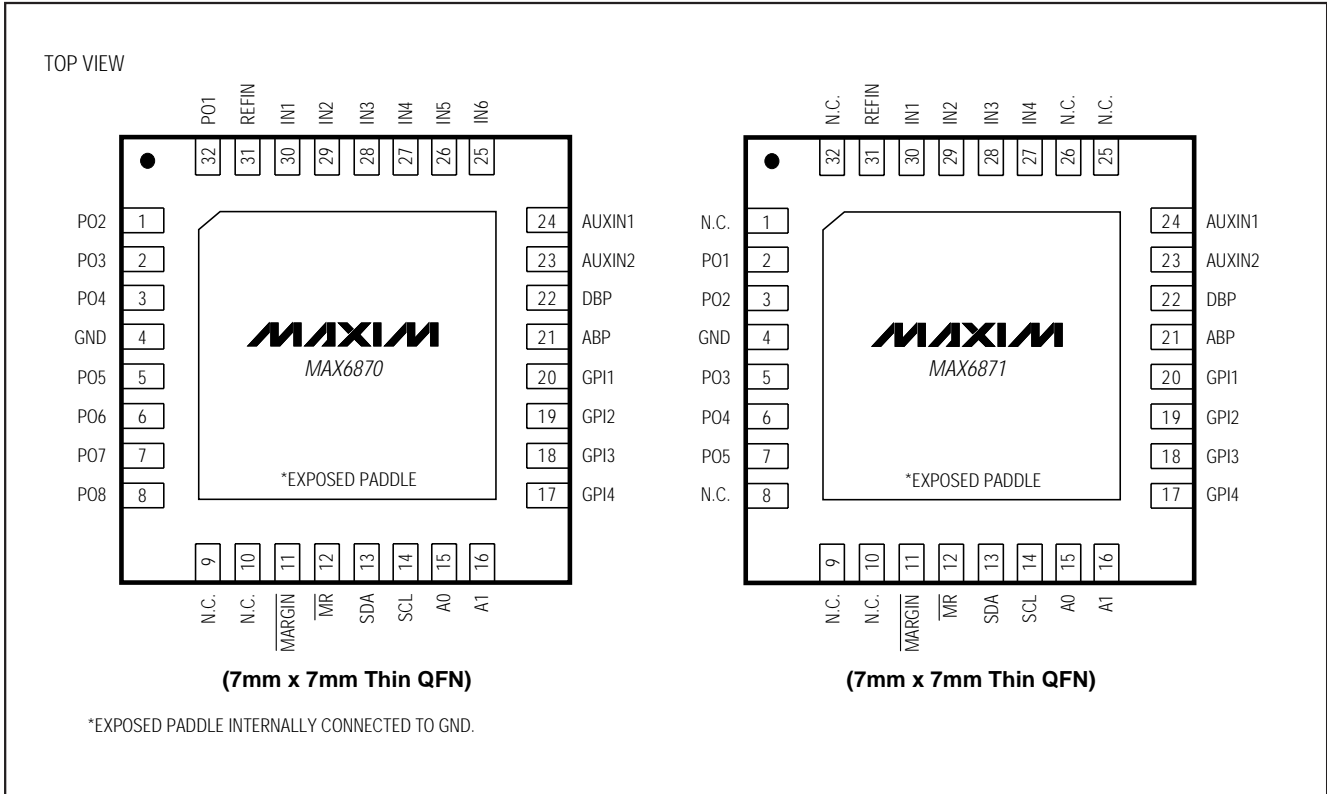

Selector Guide

PART	VOLTAGE-DETECTOR INPUTS	INTERNAL ADC	GENERAL-PURPOSE INPUTS	PROGRAMMABLE OUTPUTS	AUXILIARY INPUTS
MAX6870ETJ	6	√	4	8	√
MAX6871ETJ	4	√	4	5	√

EEPROM-Programmable Hex/Quad Power-Supply Sequencers/Supervisors with ADC

Typical Operating Circuit

MAX6870/MAX6871

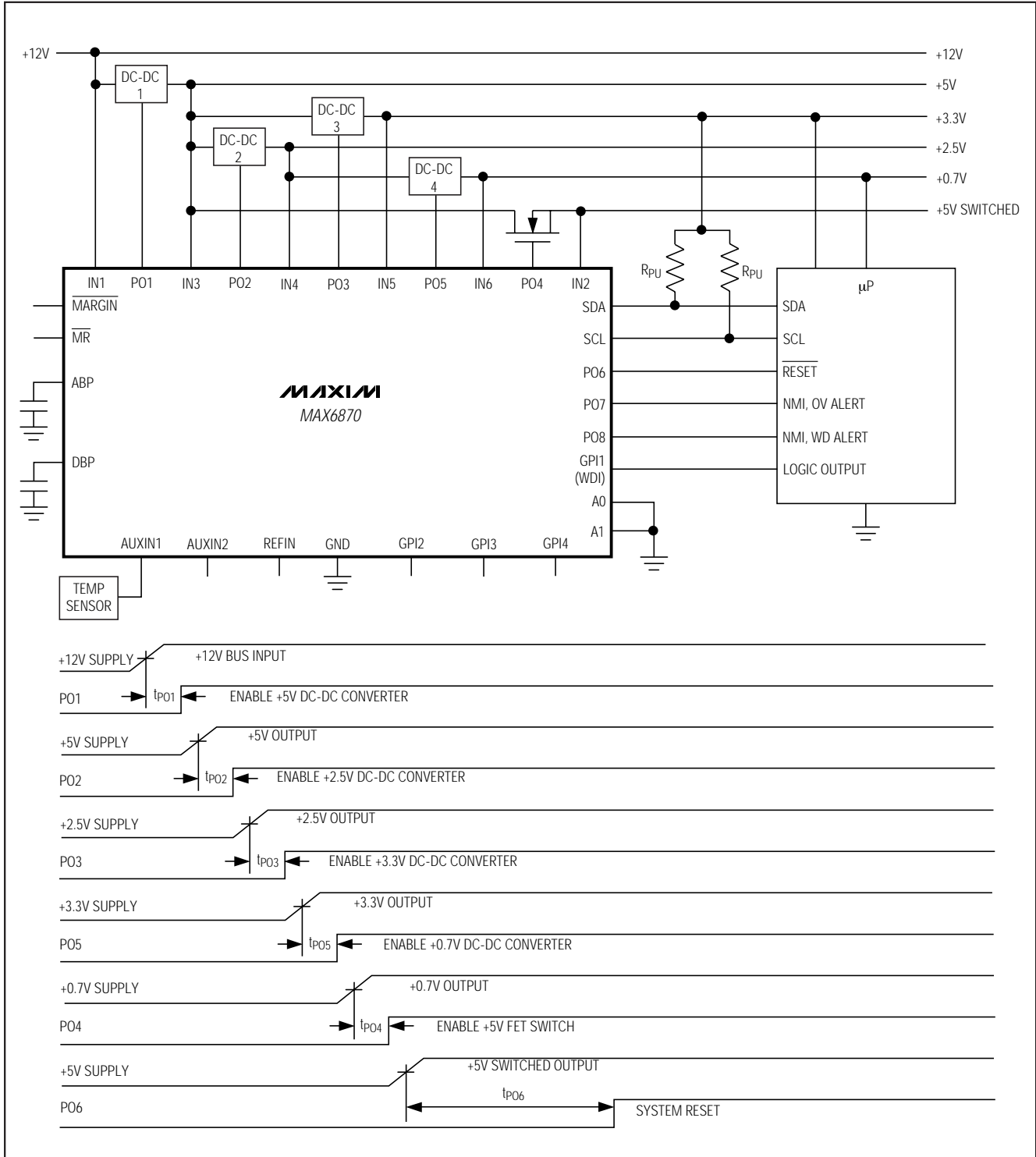

EEPROM-Programmable Hex/Quad Power-Supply Sequencers/Supervisors with ADC

Package Information

(The package drawing(s) in this data sheet may not reflect the most current specifications. For the latest package outline information, go to www.maxim-ic.com/packages.)

