



*illustration similar

4S HY-Di® Smart Batteries

HY-Di-4SyP-z1

- 4S Li-Ion Battery pack
- 14.4V nominal voltage
- Up to 96Wh capacity and 8.8A discharge
- Fuel gauge with 4 LEDs
- SM-Bus or CAN-Bus interface
- IEC + UN certified, UL in preparation

4S HY-Di® Smart Batteries – HY-Di-4SyP-z1

Content

Content.....	2
Specifications.....	3
BMS specifications	5
Mechanical.....	6
Drawing 4S1P.....	6
Drawing 4S2P.....	7
Connector.....	8
Serial number code.....	8
LED Definition	9
Photos	10
Accessoires	10
Safety Instructions	11
Contact.....	12

4S HY-Di® Smart Batteries – HY-Di-4SyP-z1

Specifications

Item	Descriptions	Specifications	Remark
1	Model Number	HY-Di-4SyP-z1	y = numbers of parallel z = communication bus
2	Cell	Panasonic NCR18650BF	
3	Configuration	4S1P 4S2P	HY-Di-4S1P-S1 for SM-Bus HY-Di-4S1P-C1 for CAN-Bus HY-Di-4S2P-S1 for SM-Bus HY-Di-4S2P-C1 for CAN-Bus
4	Nominal Voltage	14.4V	3.6V*4S
5	Nominal Capacity	4S1P: 3.35Ah 4S2P: 6.7Ah	3.35Ah*1P=3.35Ah 3.35Ah*2P=6.7Ah
6	Watt-Hour (UN38.3)	4S1P: 48Wh 4S2P: 96Wh	12.06Wh*4pcs 12.06Wh*8pcs
7	Internal Resistance	tbd	
8	Recommended operation Temperature	Standard Charge Standard Discharge	0°C ... +45°C -20°C ... +60°C
9	Storage condition	< one month < three months < one year	-20°C ... +50°C -20°C ... +40°C -20°C ... +20°C Percentage of recoverable capacity 80%
10	Charging Voltage (Maximum)	16.8V	
11	Charge Current	4S1P: <1.6A 4S2P: <3.2A	
12	Discharge Current avg.	4S1P: 3.5A 4S2P: 7.0A	
13	Discharge Current peak	4S1P: 4.4A 4S2P: 8.8A	For 10min.
14	BMS Chip	TI BQ40Z50-R1	
15	BMS Design	(1) Over voltage protection (2) Under voltage protection (3) Over current protection (4) Short circuit protection (5) Over temperature protection (6) Under temperature protection (7) Cell balance (8) SM-Bus / CAN-Bus communication (9) Fuel gauge with 4 LEDs and 1 button	
16	Connection type and pin definition	AMP 787614-1 5-pin P+, SCL/CAN-H, SDA/CAN-L, NC/PRESET, P-	
17	Parameter file	upon request	

4S HY-Di® Smart Batteries – HY-Di-4SyP-z1

Specifications

Item	Descriptions	Specifications	Remark
18	Enclosure	PC+ABS, Sabic C6600, black, UL94-V0	
19	Weight (g)	4S1P: ~250-300g 4S2P: ~450-500g	
20	Dimension(mm)	4S1P: L88 * W80 * H22.5 (mm) 4S2P: L153 * W80 * H22.5 (mm)	
21	IP standard	IP20	
22	Certifications	UN38.3 7 th edition IEC62133-2:2017 IEC60601-1-2:2014 CE	
23	Specifications SM-Bus	SM-Bus: SBS1.1	
24	Specifications CAN-Bus	CAN-Bus: HY-LINE_CAN_Protocol_3.0_Rev.2 500kBit/s	upon request

4S HY-Di® Smart Batteries – HY-Di-4SyP-z1

BMS specifications

Item	Descriptions	Specification	Remark
1	PCM	4S-32A	
2	Dimension	71*18.8*1.2mm	
3	Material	FR4	
4	Over voltage protection	1 st Over voltage threshold 1 st Over voltage release 1 st Over voltage delay time 2 nd Over voltage threshold 2 nd Over voltage release 2 nd Over voltage delay time	4.25V 4.00V 2sec 4.35V no 10sec Each cell Each cell PF
5	Under voltage protection	Under voltage threshold Under voltage release Under voltage delay time	2.70V 3.00V 2sec Each cell Each cell
6	Over charge current protection	1 st Over charge current threshold 1 st Over charge current release 1 st Over charge current delay time 2 nd Over charge current threshold 2 nd Over charge current release 2 nd Over charge current delay time	3.50A (2P) 2.50A (1P) -10mA / 10sec 2sec 4.50A (2P) 3.50A (1P) -10mA / 10sec 2sec OCC1 OCC OCC1 OCC2 OCC OCC2
7	Over discharge current protection	1 st Over discharge current threshold 1 st Over discharge current release 1 st Over discharge current delay time 2 nd Over discharge current threshold 2 nd Over discharge current release 2 nd Over discharge current delay time	-9.00A (2P) -5.50A (1P) -200mA / 10sec 2sec -11.00A (2P) -7.00A (1P) -200mA / 10sec 2sec OCD1 OCD OCD1 OCD2 OCD OCD2
8	Short circuit protection	Short circuit in charge Short circuit in charge release Short circuit in discharge Short circuit in discharge release	18.5A (2P) 11.1A (1P) External release -33.3A (2P) -18.5A (1P) External release ASCC ASCD1
9	Over temperature protection	Over charge temp. threshold Over charge temp. release Over discharge temp. threshold Over discharge temp. release	50°C 45°C 65°C 60°C OTC OTC OTD OTD
10	Under temperature protection	Under charge temp. threshold Under charge temp. release Under discharge temp. threshold Under discharge temp. release	-2°C -2°C -20°C -15°C UTC UTC UTD UTD

4S HY-Di® Smart Batteries – HY-Di-4SyP-z1

Mechanical

Drawing 4S1P

Outlines in mm: 88 x 80 x 22.5

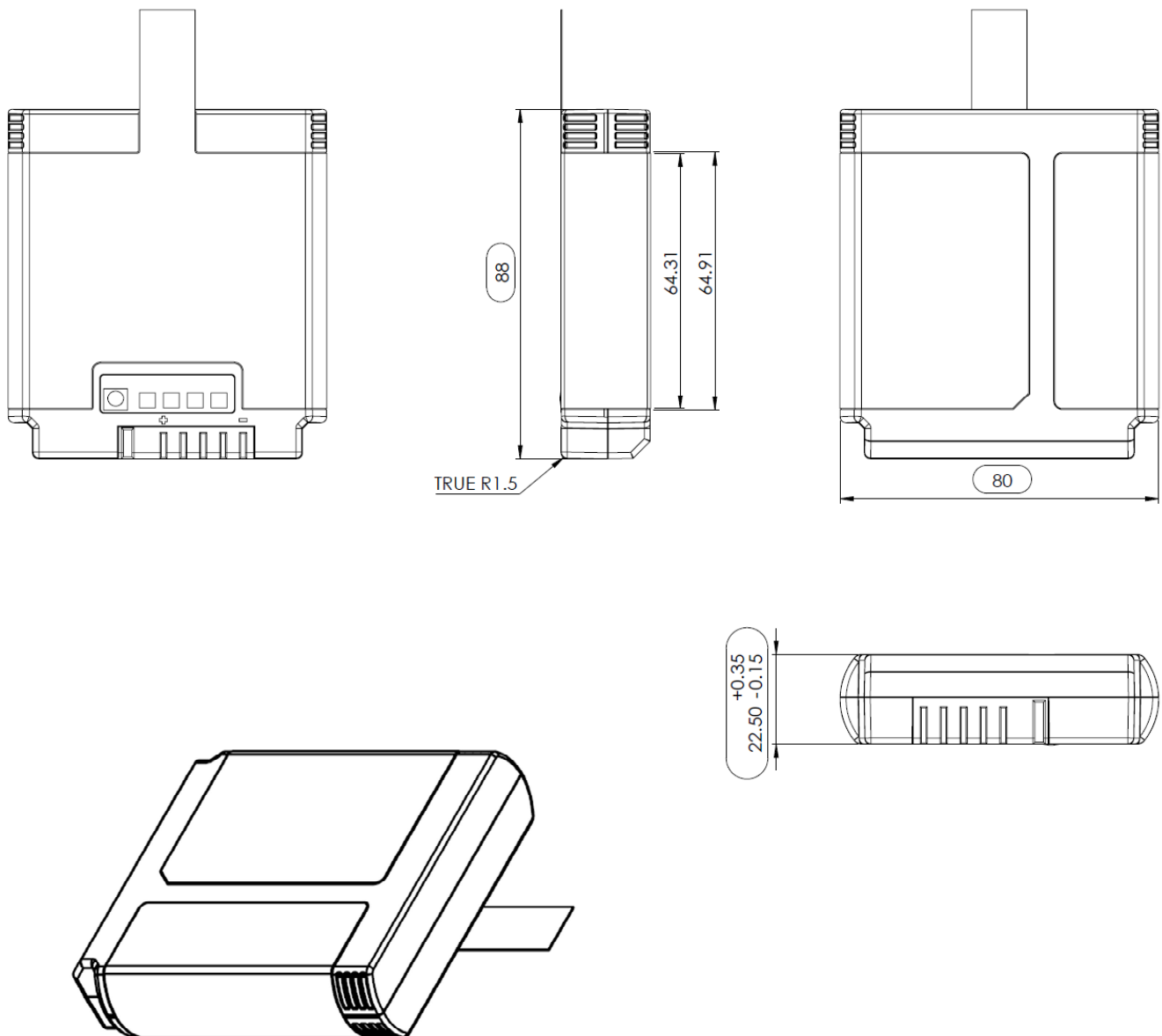

4S HY-Di® Smart Batteries – HY-Di-4SyP-z1

Drawing 4S2P

Outlines in mm: 153 x 80 x 22.5

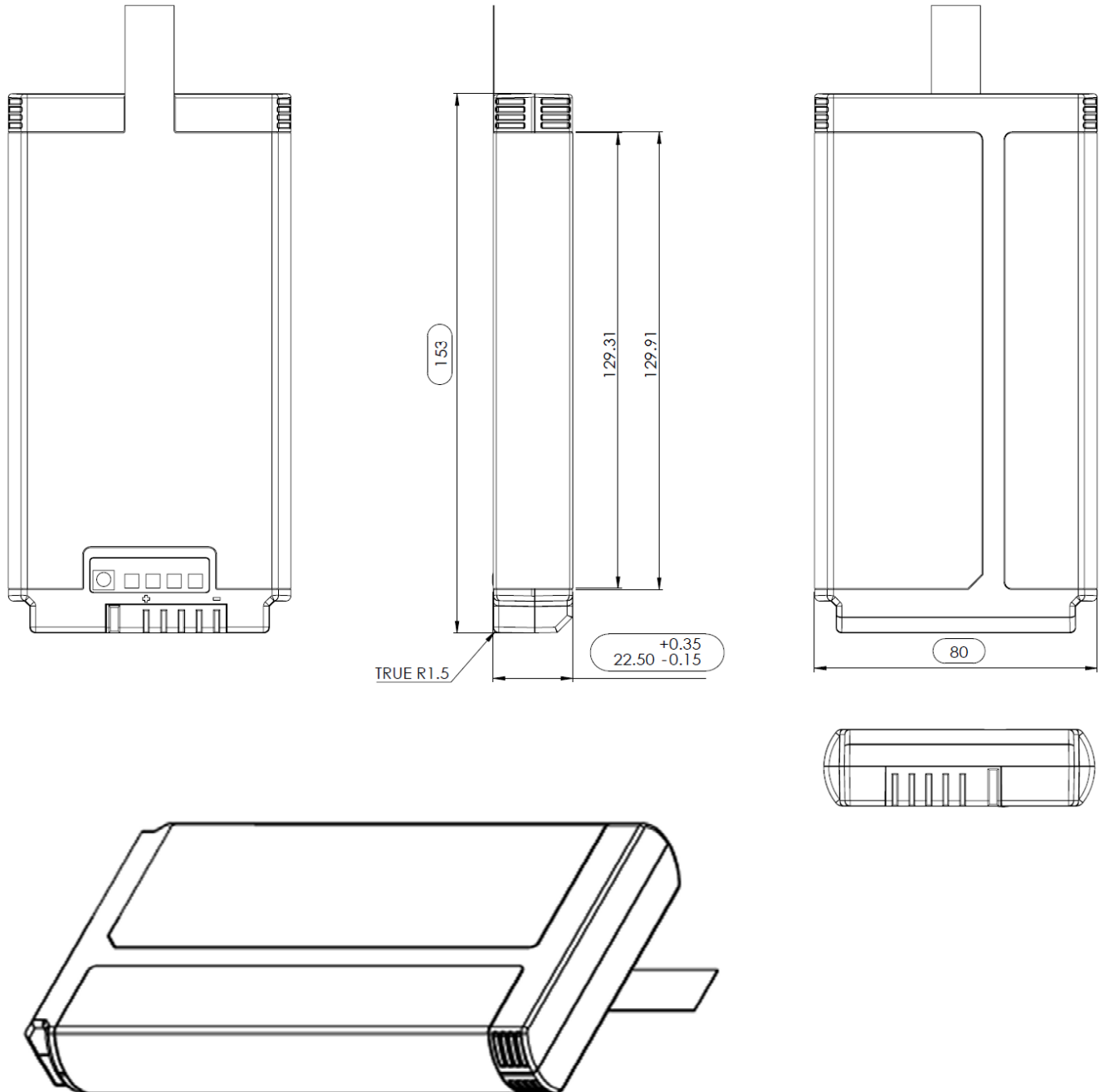

4S HY-Di® Smart Batteries – HY-Di-4SyP-z1

Connector

Type: AMP 787614-1 5-pin connector

Configuration for SM-Bus

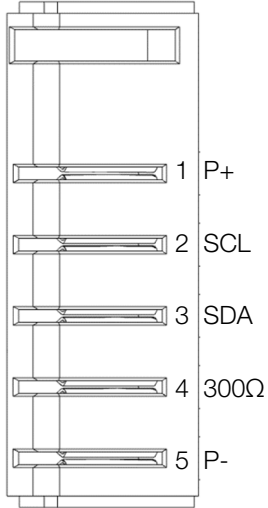

Configuration for CAN-Bus

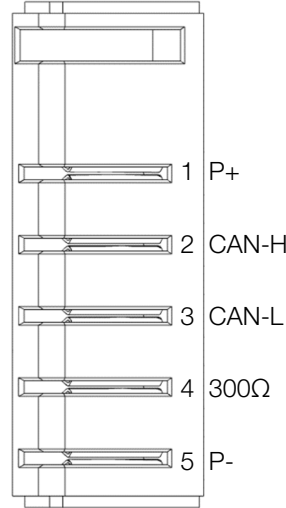

Device Counterpart for CAN-Bus

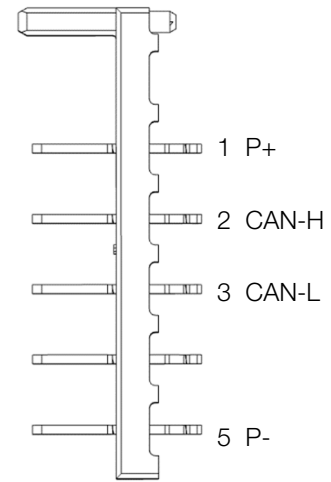

Pin	SM-Bus	CAN-Bus
1	Battery +	Battery +
2	SM-Bus clock	CAN-high
3	SM-Bus data	CAN-low
4	300 Ω to P-	300 Ω to P-
5	Battery -	Battery -

Serial number code

























Example: HY-Di-4S1P-S1-1-1521-00000

Part Number	Hardware Rev.	Production Date wwyy	Serial Number
HY-Di-4S1P-S1	-1	-1521	-00000





















4S HY-Di® Smart Batteries – HY-Di-4SyP-z1

LED Definition

Charging status of LED (During charging)

No.	SOC	Description	LED Indicator
1	0 ~ 12% of SOC	1 st LED is flashing fast	 <input type="checkbox"/> <input type="checkbox"/> <input type="checkbox"/>
2	13 ~ 24% of SOC	1 st LED is flashing slow	 <input type="checkbox"/> <input type="checkbox"/> <input type="checkbox"/>
3	25 ~ 37% of SOC	1 st LED is "On" / 2 nd LED is flashing fast	  <input type="checkbox"/> <input type="checkbox"/>
4	38 ~ 49% of SOC	1 st LEDs is "On" / 2 nd LED is flashing slow	  <input type="checkbox"/> <input type="checkbox"/>
5	50 ~ 62% of SOC	1 st ~ 2 nd LEDs are "On" / 3 rd LED is flashing fast	   <input type="checkbox"/>
6	63 ~ 74% of SOC	1 st ~ 2 nd LEDs are "On" / 3 rd LED is flashing slow	   <input type="checkbox"/>
7	75 ~ 87% of SOC	1 st ~ 3 rd LEDs are "On" / 4 th LED is flashing fast	   
8	88 ~ 100% of SOC	1 st ~ 3 rd LEDs are "On" / 4 th LED is flashing slow	   
9	Fully Charged	1 st /3 rd LED are "On" / 2 nd /4 th LED are flashing fast	   

Discharge status of LED (After pushing the button)

No.	SOC	Description	LED Indicator
1	0 ~ 12% of SOC	1 st LED is flashing slow	 <input type="checkbox"/> <input type="checkbox"/> <input type="checkbox"/>
2	13 ~ 24% of SOC	1 st LED is "On"	 <input type="checkbox"/> <input type="checkbox"/> <input type="checkbox"/>
3	25 ~ 37% of SOC	1 st LED is "On" / 2 nd LED is flashing slow	  <input type="checkbox"/> <input type="checkbox"/>
4	38 ~ 49% of SOC	1 st /2 nd LED are "On"	  <input type="checkbox"/> <input type="checkbox"/>
5	50 ~ 62% of SOC	1 st /2 nd LED are "On" / 3 rd LED is flashing slow	   <input type="checkbox"/>
6	63 ~ 74% of SOC	1 st ~ 3 rd LEDs are "On"	   <input type="checkbox"/>
7	75 ~ 87% of SOC	1 st ~ 3 rd LEDs are "On" / 4 th LED is flashing slow	   
8	88 ~ 100% of SOC	1 st ~ 4 th LEDs are "On"	   

4S HY-Di® Smart Batteries – HY-Di-4SyP-z1

Photos

Product Family (*illustration similar)

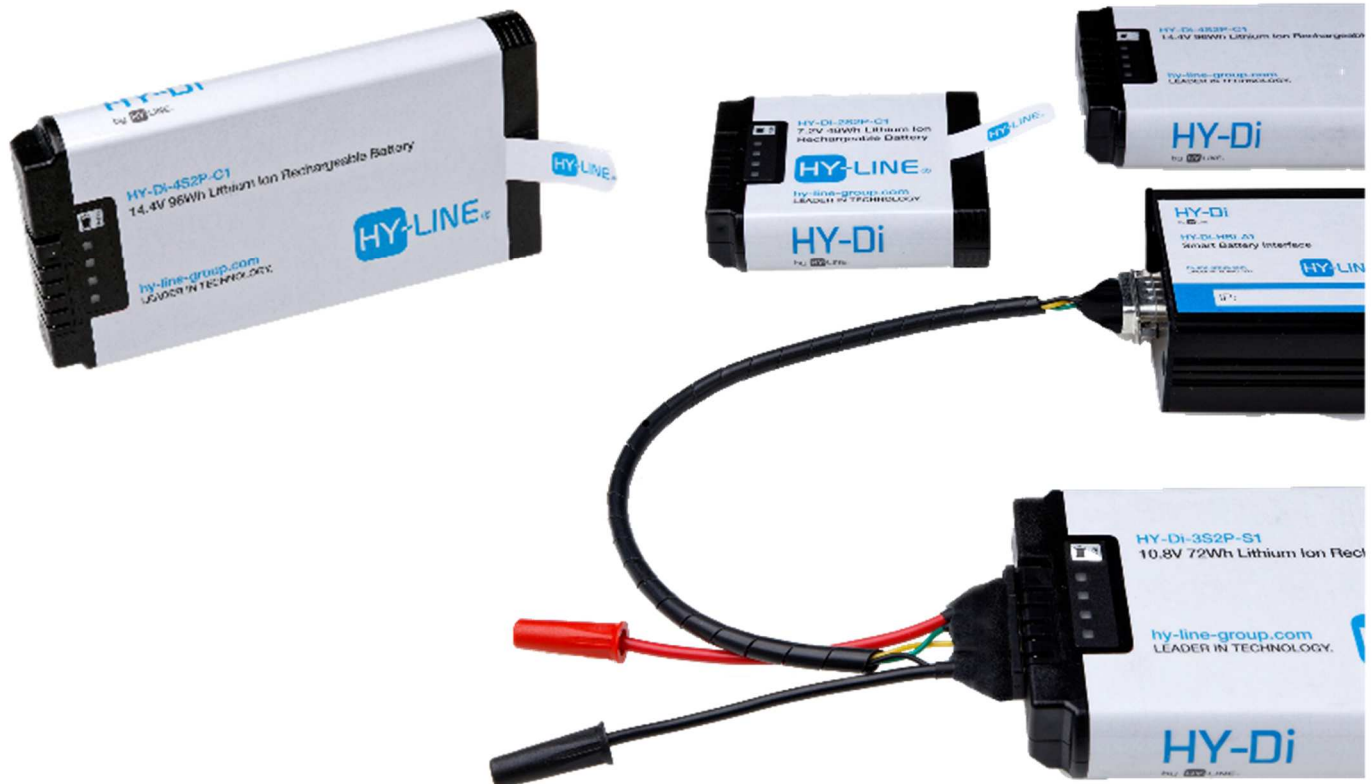

Accessoires

Item	Part number	Remark
Dual Bay Charger	HY-Di-CHG-A1	suitable for 2S, 3S and 4S HY-LINE batteries
Battery PC Interface	HY-Di-HBI-A1	for SM-Bus and CAN-Bus
Cable CAN-Bus	HK-HBI-CAN01	Connection cable for HY-LINE Smart Battery to Battery Interface with AMP Con for CAN-Bus
Cable SM-Bus	HK-HBI-SM01	Connection cable for Smart Battery to Battery Interface with AMP Con for SM-Bus
Cable HBI to terminal block 5pin	HK-HBI-Multi01	Connection cable HBI to terminal block (5pin), CAN- and SM-Bus
Cable HBI to charger	HK-HBI-CH01	Connection cable HBI to HY-LINE Smart Battery Charger (HY-Di-CHG-A1)
Cadex C7 adapter	07-111-7080-00	CADEX Adapter for HY-LINE Smart Batteries to CADEX C7x00 battery analyser
Counterpart connector for battery connector AMP 787614-1	5787419-1	 AMP DC Jack Connectors, Board-to-Board, 5 Positions, Pitch 5mm, with flange
	5787444-1	

4S HY-Di® Smart Batteries – HY-Di-4SyP-z1

Safety Instructions

- Never disassemble or modify the battery pack.
- Do not pierce the battery pack with a nail, strike it with a hammer, step on it or otherwise subject it to strong impact.
- Do not immerse the battery in water or sea water or get it wet.
- Do not use or leave battery nearby fire, stove, or heated place (more than 80°C)
- Do not store the battery in high humidity or in the place with which may expose the battery to rain or water.
- The product will shut down and no output if the product is interfered by EMC. After removing and installing, the product will be workable normally.
- Careful consideration of this information is essential when stacking or collocating equipment and when routing cables and accessories.
- Please do not use any other cables or accessories not approved by the manufacturer in this manual to avoid negative influence on electromagnetic compatibility.
- This equipment is not intended for use in residential environments and may not provide adequate protection to radio reception in such environments.
- The produce is a steady DC output power source, it does not produce noise to interference the ME equipment. The product involves components for Antistatic (ESD) to prevent ESD destruction. And apply multiple layers (4 layers) for PCB to enhance the strength to resist external radiation. The product has a strong surge absorption capacity to prevent EFT. The product also has been passed IEC62133 2nd certification and relevant tests.
- Electric devices may interact due to electro-magnetic radiation. We recommend a safety distance of at least 1-metre especially for sensitive equipment. RF mobile communications equipment can affect medical electrical equipment. Medical electrical equipment needs special precautions regarding EMC and needs to be installed according to the EMC information provided.

Charging:

- It is not allowed that the battery pack voltage is out of the specification.
- It is not allowed that the charge current is out of the specification.
- It is not allowed that the battery pack temperature is out of specification.
- It is not allowed that the battery pack cannot operate suddenly although the battery pack voltage, charge current and temperature is within the specification.

Discharging:

- It is not allowed that the battery pack voltage is out of the specification.
- It is not allowed that the charge current is out of the specification.
- It is not allowed that the battery pack temperature is out of specification.
- It is not allowed that the battery pack cannot operate suddenly although the battery pack voltage, charge current and temperature is within the specification.

4S HY-Di® Smart Batteries – HY-Di-4SyP-z1

Contact

HY-LINE AG

Hochstrasse 355
CH-8200 Schaffhausen

Support:

+41 (0) 52 / 647 42 00

+41 (0) 52 / 647 42 01

Mail us:

info@hy-line.ch

HY-LINE Power Components Vertriebs GmbH

Inselkammerstrasse 10
D-82008 Unterhaching

Support:

+49 (0) 89 / 614 503 10

+49 (0) 89 / 614 503 20

Mail us:

power@hy-line.de



HY-LINE AG

HY-LINE AG belongs to the HY-LINE group, a group of specialized distributors.

HY-LINE AG is a specialist in batteries and systems. In addition to standard batteries and charging and maintenance systems, the focus is on the development and design of custom-specific batteries and systems.

HY-LINE Power Components Vertriebs GmbH

HY-LINE Power Components is part of the HY-LINE Group, a group of specialized distributors.

HY-LINE Power Components supplies all core parts and components for power electronics and power supply technology. As a highly specialized distributor and manufacturer representative, HY-LINE Power Components has extensive application-specific know-how and provides support already during the design phase in the selection of components and the configuration of coordinated subsystems.

HY-LINE® is a registered trademark of the HY-LINE Group.
Printed in the Federal Republic of Germany.
Datasheet HY-Di 4S Smart Batteries | November 2021
Subject to changes without notice | All Information without guarantee
© 2021, HY-LINE Group