

NGTB40N120FL2WG

IGBT - Field Stop II

This Insulated Gate Bipolar Transistor (IGBT) features a robust and cost effective Field Stop II Trench construction, and provides superior performance in demanding switching applications, offering both low on state voltage and minimal switching loss. The IGBT is well suited for UPS and solar applications. Incorporated into the device is a soft and fast co-packaged free wheeling diode with a low forward voltage.

Features

- Extremely Efficient Trench with Field Stop Technology
- $T_{Jmax} = 175^{\circ}C$
- Soft Fast Reverse Recovery Diode
- Optimized for High Speed Switching
- 10 μs Short Circuit Capability
- These are Pb-Free Devices

Typical Applications

- Solar Inverter
- Uninterruptible Power Inverter Supplies (UPS)
- Welding

ABSOLUTE MAXIMUM RATINGS

| Rating | Symbol | Value | Unit |
|--|-----------|----------------------|-------------|
| Collector-emitter voltage | V_{CES} | 1200 | V |
| Collector current @ $T_c = 25^{\circ}C$ @ $T_c = 100^{\circ}C$ | I_C | 80 40 | A |
| Pulsed collector current, T_{pulse} limited by T_{Jmax} | I_{CM} | 200 | A |
| Diode forward current @ $T_c = 25^{\circ}C$ @ $T_c = 100^{\circ}C$ | I_F | 80 40 | A |
| Diode pulsed current, T_{pulse} limited by T_{Jmax} | I_{FM} | 200 | A |
| Gate-emitter voltage Transient gate-emitter voltage ($T_{pulse} = 5 \mu s$, $D < 0.10$) | V_{GE} | ± 20 ± 30 | V |
| Power Dissipation @ $T_c = 25^{\circ}C$ @ $T_c = 100^{\circ}C$ | P_D | 535 267 | W |
| Short Circuit Withstand Time $V_{GE} = 15 V$, $V_{CE} = 500 V$, $T_J \leq 150^{\circ}C$ | T_{SC} | 10 | μs |
| Operating junction temperature range | T_J | -55 to $+175$ | $^{\circ}C$ |
| Storage temperature range | T_{stg} | -55 to $+175$ | $^{\circ}C$ |
| Lead temperature for soldering, 1/8" from case for 5 seconds | T_{SLD} | 260 | $^{\circ}C$ |

Stresses exceeding those listed in the Maximum Ratings table may damage the device. If any of these limits are exceeded, device functionality should not be assumed, damage may occur and reliability may be affected.



ON Semiconductor®

www.onsemi.com

40 A, 1200 V
 $V_{CEsat} = 2.0 V$
 $E_{off} = 1.10 mJ$

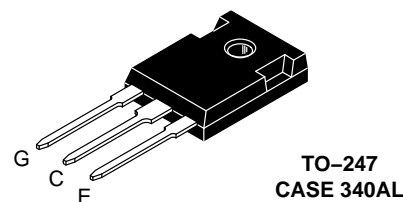
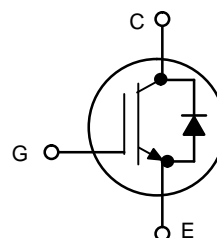

MARKING DIAGRAM



A = Assembly Location
 Y = Year
 WW = Work Week
 G = Pb-Free Package

ORDERING INFORMATION

| Device | Package | Shipping |
|-----------------|------------------|-----------------|
| NGTB40N120FL2WG | TO-247 (Pb-Free) | 30 Units / Rail |

NGTB40N120FL2WG

THERMAL CHARACTERISTICS

| Rating | Symbol | Value | Unit |
|--|-----------------|-------|-----------------------------|
| Thermal resistance junction-to-case, for IGBT | $R_{\theta JC}$ | 0.28 | $^{\circ}\text{C}/\text{W}$ |
| Thermal resistance junction-to-case, for Diode | $R_{\theta JC}$ | 0.5 | $^{\circ}\text{C}/\text{W}$ |
| Thermal resistance junction-to-ambient | $R_{\theta JA}$ | 40 | $^{\circ}\text{C}/\text{W}$ |

ELECTRICAL CHARACTERISTICS ($T_J = 25^{\circ}\text{C}$ unless otherwise specified)

| Parameter | Test Conditions | Symbol | Min | Typ | Max | Unit |
|-----------|-----------------|--------|-----|-----|-----|------|
|-----------|-----------------|--------|-----|-----|-----|------|

STATIC CHARACTERISTIC

| | | | | | | |
|---|---|---------------|------|--------------|-----------|----|
| Collector-emitter breakdown voltage, gate-emitter short-circuited | $V_{GE} = 0\text{ V}, I_C = 500\ \mu\text{A}$ | $V_{(BR)CES}$ | 1200 | – | – | V |
| Collector-emitter saturation voltage | $V_{GE} = 15\text{ V}, I_C = 40\text{ A}$ $V_{GE} = 15\text{ V}, I_C = 40\text{ A}, T_J = 175^{\circ}\text{C}$ | V_{CEsat} | – | 2.00 2.40 | 2.40 – | V |
| Gate-emitter threshold voltage | $V_{GE} = V_{CE}, I_C = 400\ \mu\text{A}$ | $V_{GE(th)}$ | 4.5 | 5.5 | 6.5 | V |
| Collector-emitter cut-off current, gate-emitter short-circuited | $V_{GE} = 0\text{ V}, V_{CE} = 1200\text{ V}$ $V_{GE} = 0\text{ V}, V_{CE} = 1200\text{ V}, T_J = 175^{\circ}\text{C}$ | I_{CES} | – | – | 0.1 2 | mA |
| Gate leakage current, collector-emitter short-circuited | $V_{GE} = 20\text{ V}, V_{CE} = 0\text{ V}$ | I_{GES} | – | – | 200 | nA |

| | | | | | | |
|------------------------------|--|-----------|---|------|---|----|
| Input capacitance | $V_{CE} = 20\text{ V}, V_{GE} = 0\text{ V}, f = 1\text{ MHz}$ | C_{ies} | – | 7385 | – | pF |
| Output capacitance | | C_{oes} | – | 230 | – | |
| Reverse transfer capacitance | | C_{res} | – | 140 | – | |
| Gate charge total | $V_{CE} = 600\text{ V}, I_C = 40\text{ A}, V_{GE} = 15\text{ V}$ | Q_g | – | 313 | – | nC |
| Gate to emitter charge | | Q_{ge} | – | 61 | – | |
| Gate to collector charge | | Q_{gc} | – | 151 | – | |

SWITCHING CHARACTERISTIC, INDUCTIVE LOAD

| | | | | | | | |
|-------------------------|--|--------------|---|-----|---|----|----|
| Turn-on delay time | $T_J = 25^{\circ}\text{C}$ $V_{CC} = 600\text{ V}, I_C = 40\text{ A}$ $R_g = 10\ \Omega$ $V_{GE} = 0\text{ V}/15\text{ V}$ | $t_{d(on)}$ | – | 116 | – | ns | |
| Rise time | | t_r | – | 42 | – | | |
| Turn-off delay time | | $t_{d(off)}$ | – | 286 | – | | |
| Fall time | | t_f | – | 121 | – | | |
| Turn-on switching loss | | E_{on} | – | 3.4 | – | | mJ |
| Turn-off switching loss | | E_{off} | – | 1.1 | – | | |
| Total switching loss | | E_{ts} | – | 4.5 | – | | |
| Turn-on delay time | $T_J = 175^{\circ}\text{C}$ $V_{CC} = 600\text{ V}, I_C = 40\text{ A}$ $R_g = 10\ \Omega$ $V_{GE} = 0\text{ V}/15\text{ V}$ | $t_{d(on)}$ | – | 111 | – | ns | |
| Rise time | | t_r | – | 43 | – | | |
| Turn-off delay time | | $t_{d(off)}$ | – | 304 | – | | |
| Fall time | | t_f | – | 260 | – | | |
| Turn-on switching loss | | E_{on} | – | 4.4 | – | | mJ |
| Turn-off switching loss | | E_{off} | – | 2.5 | – | | |
| Total switching loss | | E_{ts} | – | 6.9 | – | | |

DIODE CHARACTERISTIC

| | | | | | | |
|--------------------------|---|-----------|---|--------------|-----------|---------------|
| Forward voltage | $V_{GE} = 0\text{ V}, I_F = 40\text{ A}$ $V_{GE} = 0\text{ V}, I_F = 50\text{ A}, T_J = 175^{\circ}\text{C}$ | V_F | – | 2.00 2.30 | 2.60 – | V |
| Reverse recovery time | $T_J = 25^{\circ}\text{C}$ $I_F = 40\text{ A}, V_R = 400\text{ V}$ $di_F/dt = 200\text{ A}/\mu\text{s}$ | t_{rr} | – | 240 | – | ns |
| Reverse recovery charge | | Q_{rr} | – | 2.5 | – | μC |
| Reverse recovery current | | I_{rrm} | – | 18 | – | A |
| Reverse recovery time | $T_J = 175^{\circ}\text{C}$ $I_F = 40\text{ A}, V_R = 400\text{ V}$ $di_F/dt = 200\text{ A}/\mu\text{s}$ | t_{rr} | – | 392 | – | ns |
| Reverse recovery charge | | Q_{rr} | – | 5.36 | – | μC |
| Reverse recovery current | | I_{rrm} | – | 25.80 | – | A |

Product parametric performance is indicated in the Electrical Characteristics for the listed test conditions, unless otherwise noted. Product performance may not be indicated by the Electrical Characteristics if operated under different conditions.

NGTB40N120FL2WG

TYPICAL CHARACTERISTICS

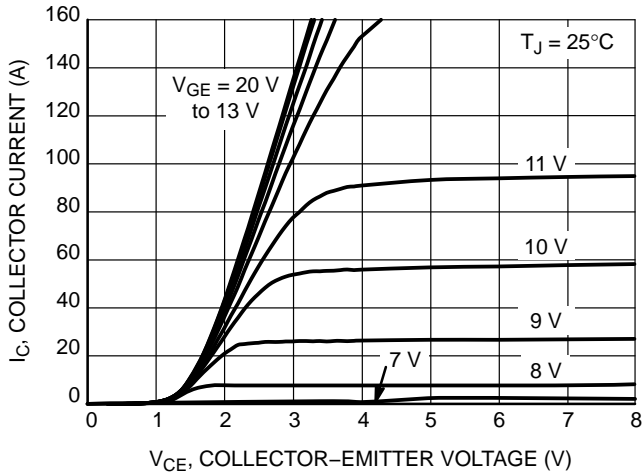

Figure 1. Output Characteristics

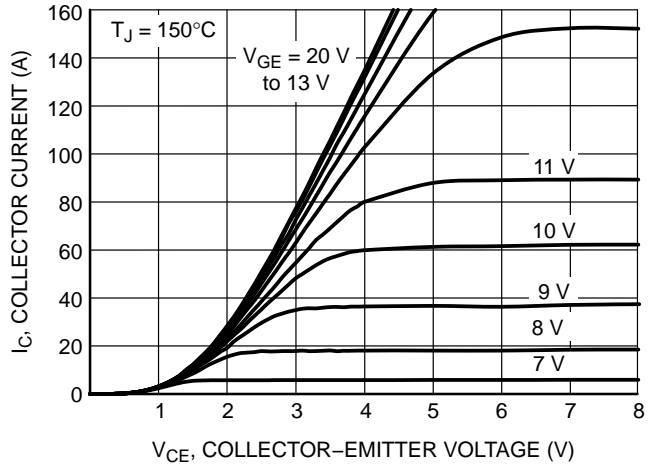

Figure 2. Output Characteristics

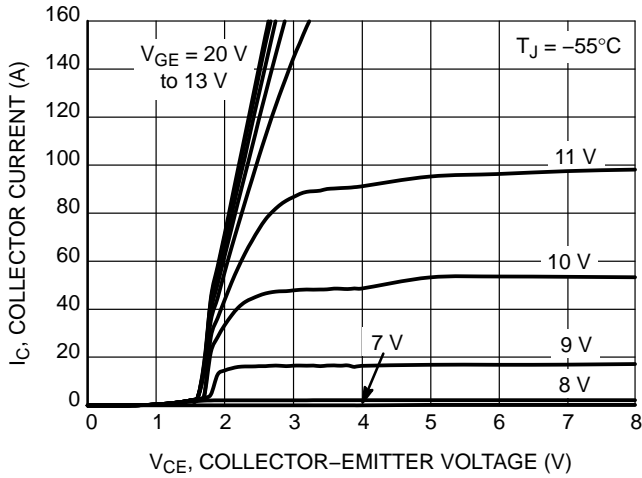

Figure 3. Output Characteristics

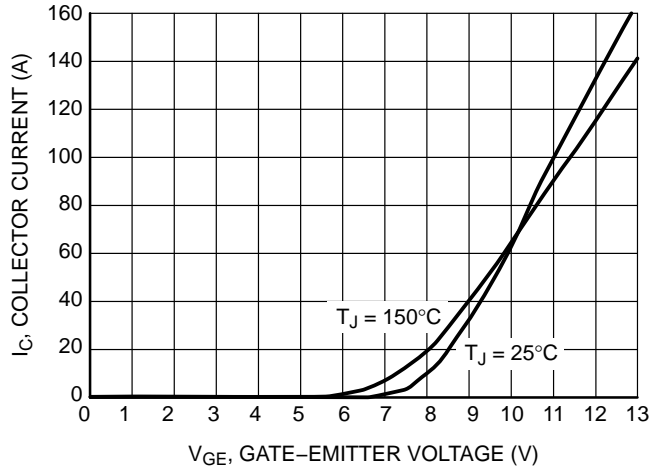

Figure 4. Typical Transfer Characteristics

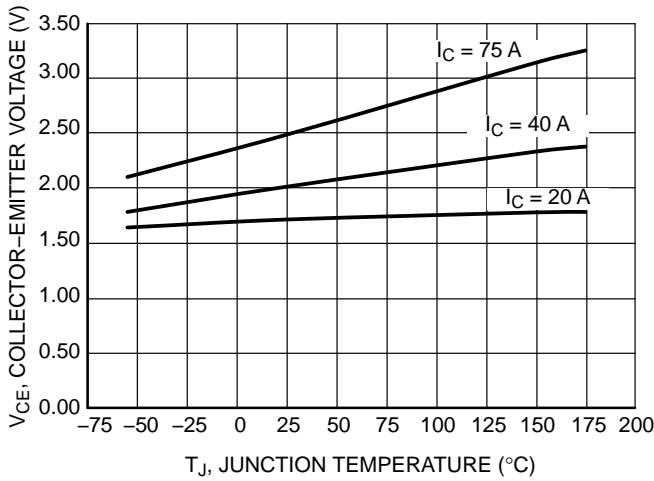

Figure 5. $V_{CE(sat)}$ vs T_J

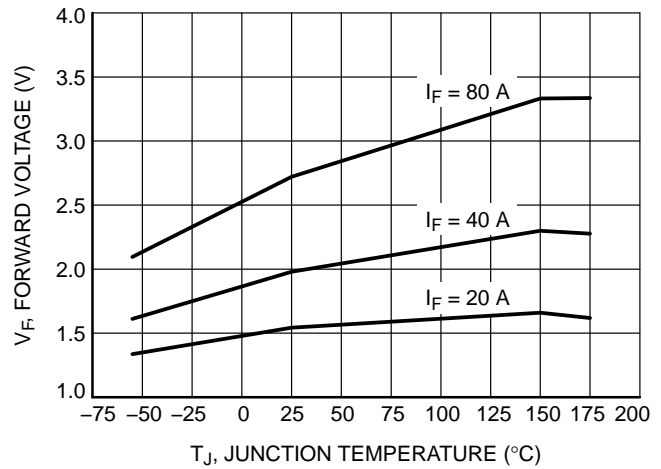

Figure 6. V_F vs. T_J

NGTB40N120FL2WG

TYPICAL CHARACTERISTICS

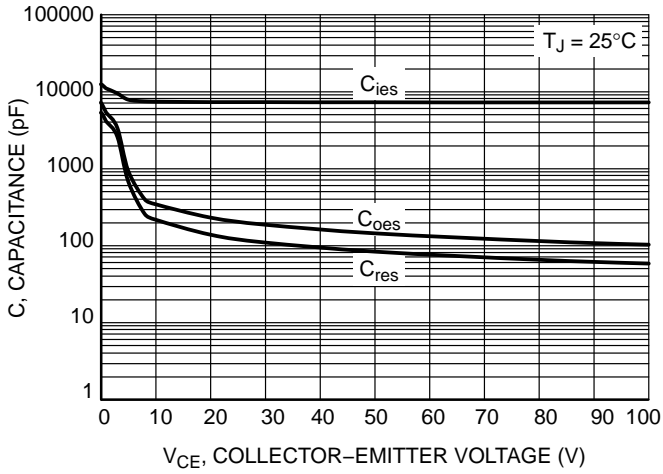

Figure 7. Typical Capacitance

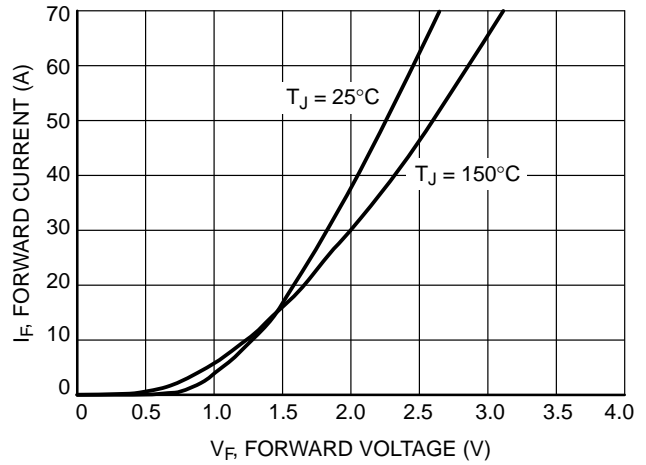

Figure 8. Diode Forward Characteristics

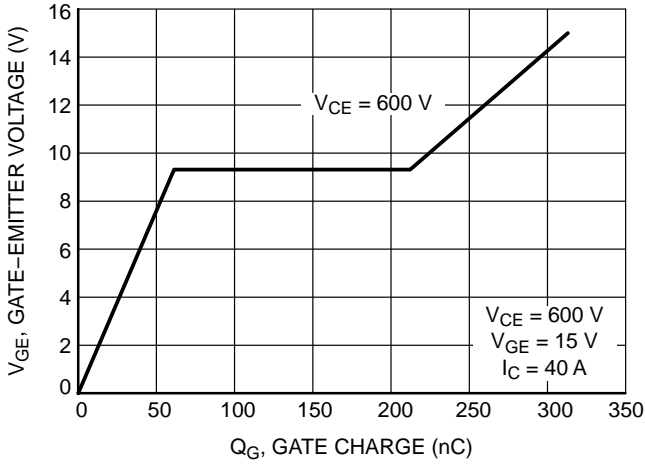

Figure 9. Typical Gate Charge

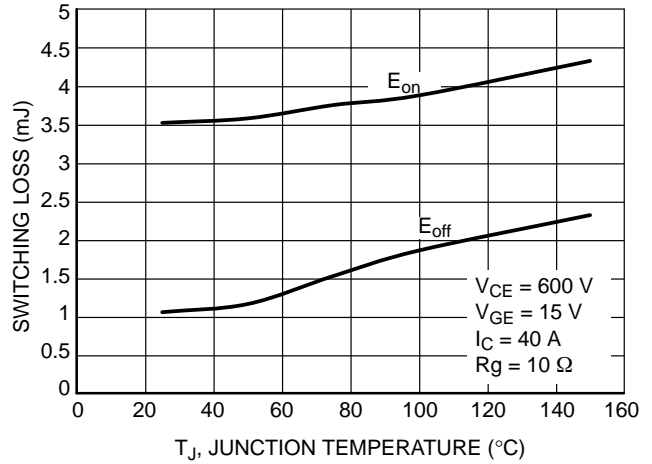

Figure 10. Switching Loss vs. Temperature

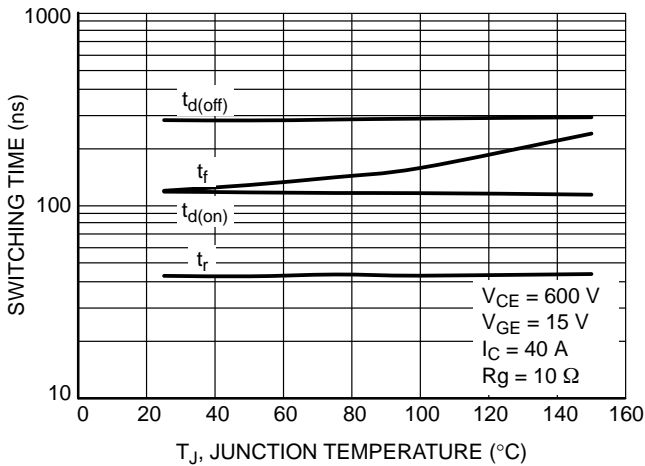

Figure 11. Switching Time vs. Temperature

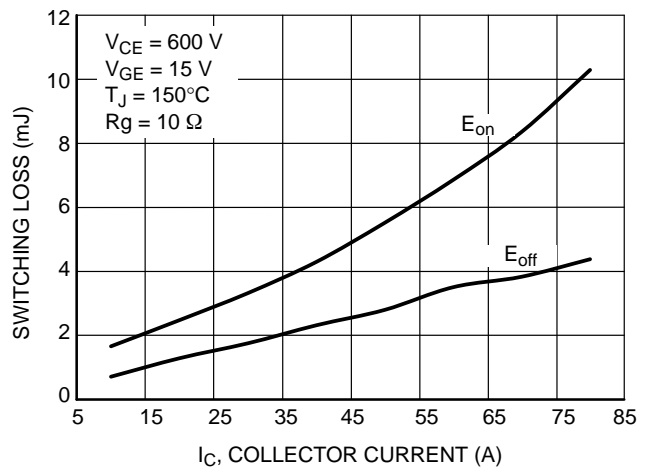

Figure 12. Switching Loss vs. I_C

NGTB40N120FL2WG

TYPICAL CHARACTERISTICS

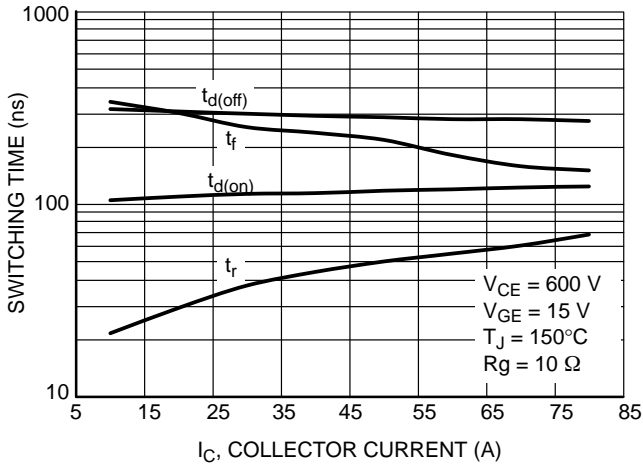

Figure 13. Switching Time vs. I_C

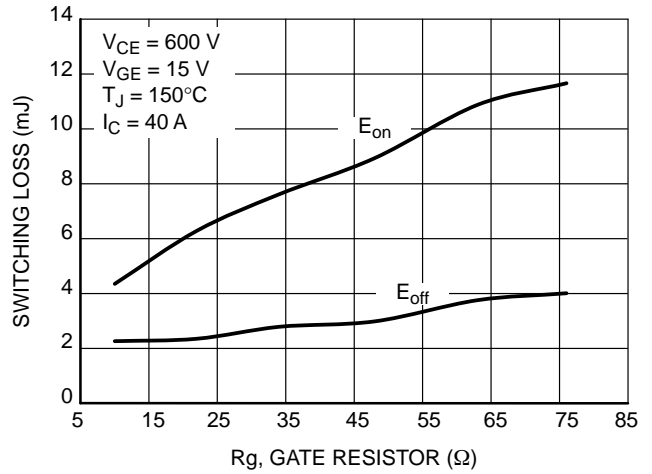

Figure 14. Switching Loss vs. R_g

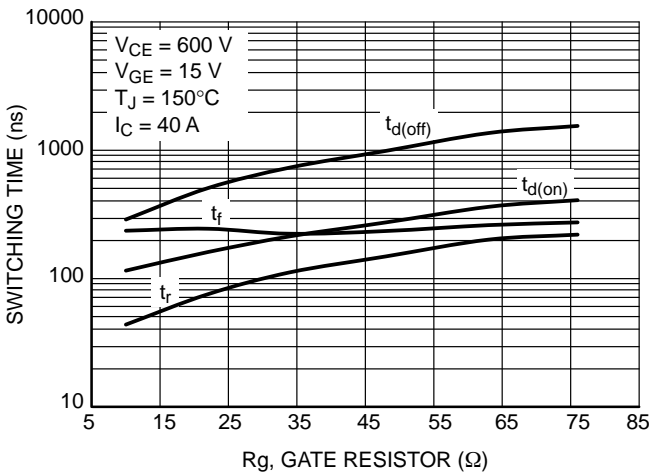

Figure 15. Switching Time vs. R_g

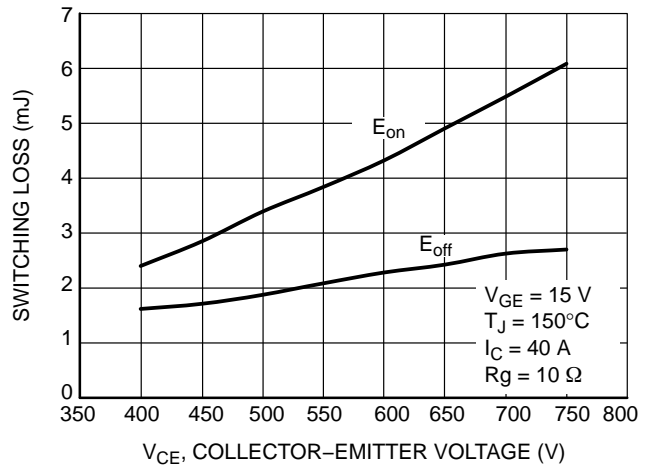

Figure 16. Switching Loss vs. V_{CE}

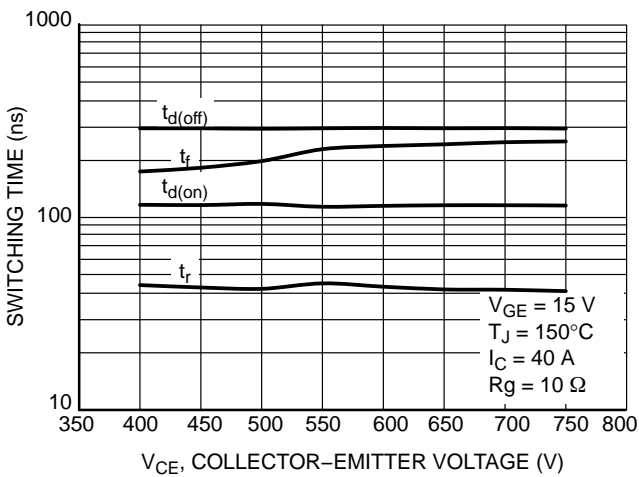

Figure 17. Switching Time vs. V_{CE}

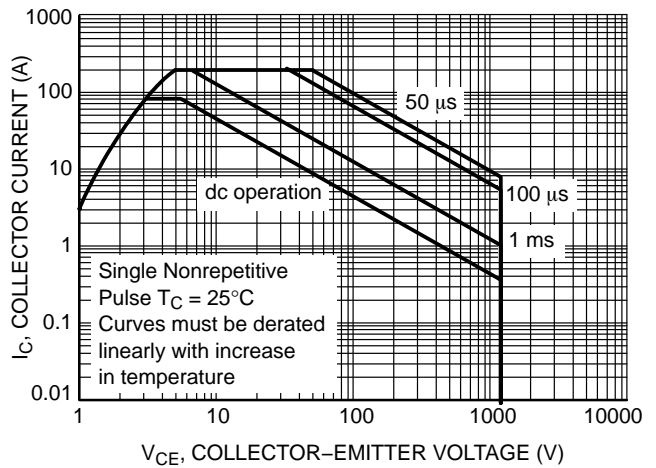

Figure 18. Safe Operating Area

NGTB40N120FL2WG

TYPICAL CHARACTERISTICS

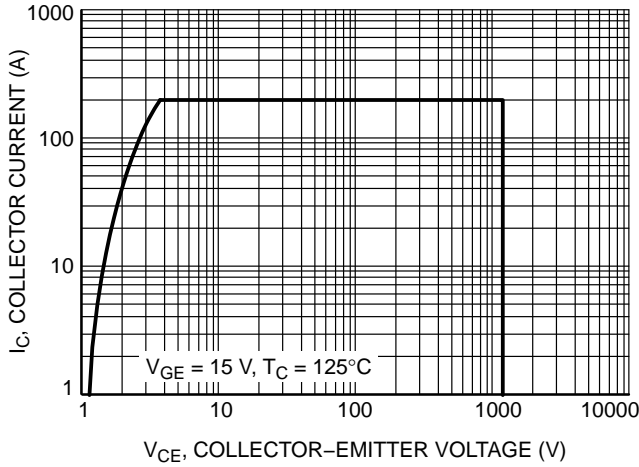

Figure 19. Reverse Bias Safe Operating Area

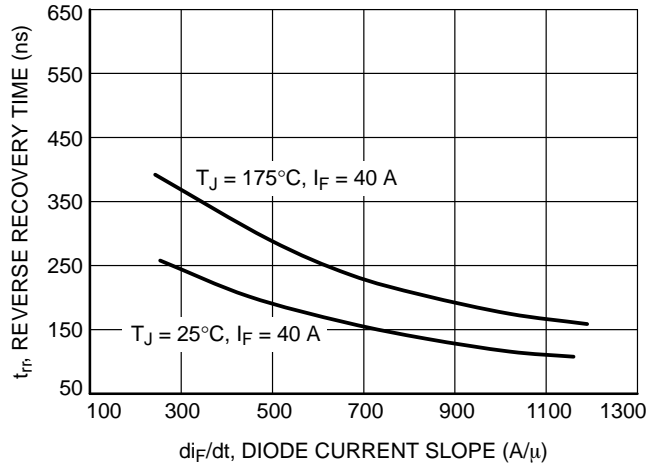

Figure 20. t_{rr} vs. di_F/dt ($V_R = 400$ V)

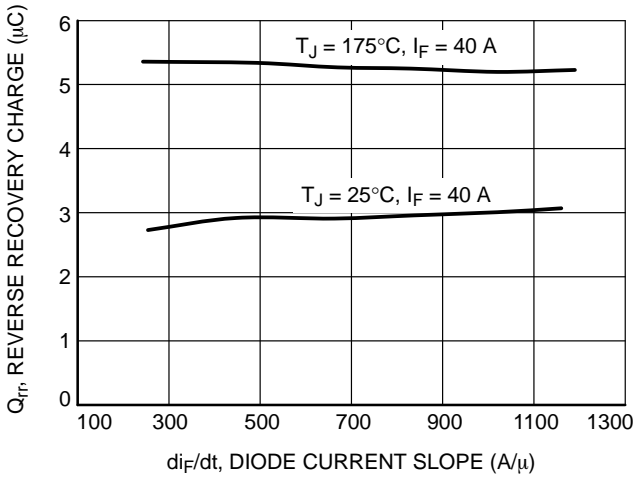

Figure 21. Q_{rr} vs. di_F/dt ($V_R = 400$ V)

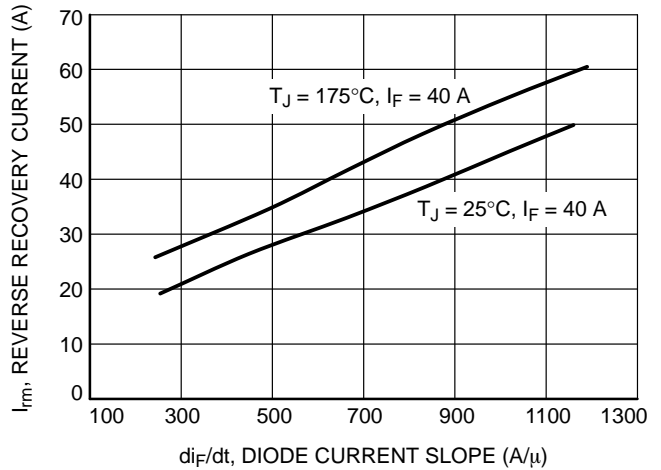

Figure 22. I_{rm} vs. di_F/dt ($V_R = 400$ V)

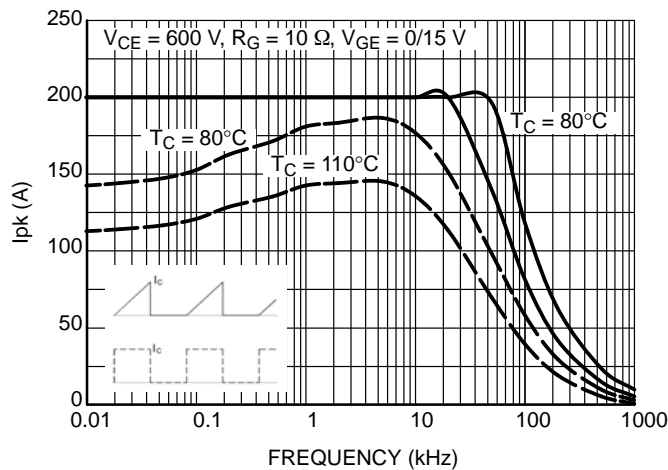

Figure 23. Collector Current vs. Switching Frequency

NGTB40N120FL2WG

TYPICAL CHARACTERISTICS

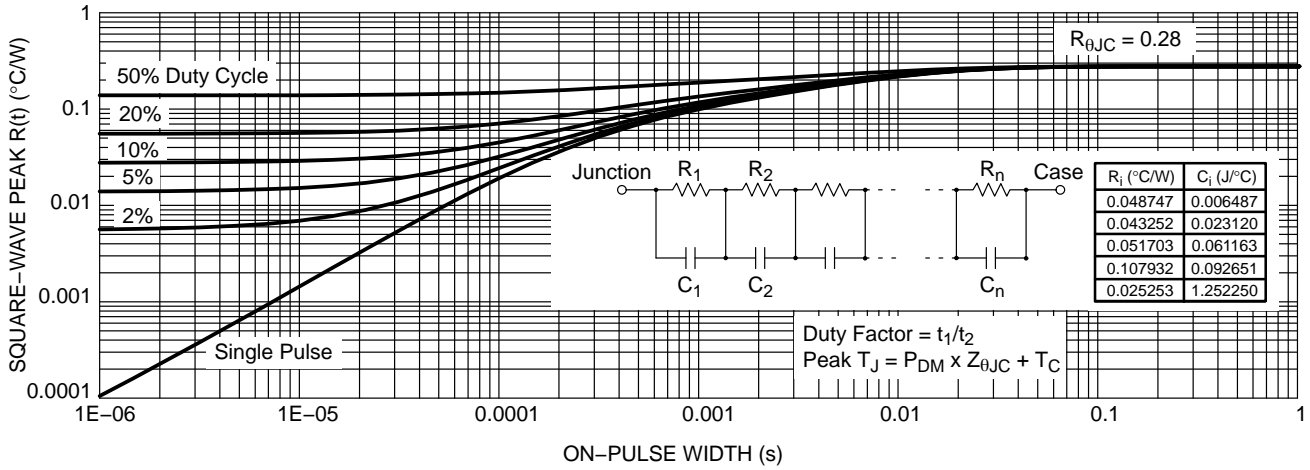

Figure 24. IGBT Transient Thermal Impedance

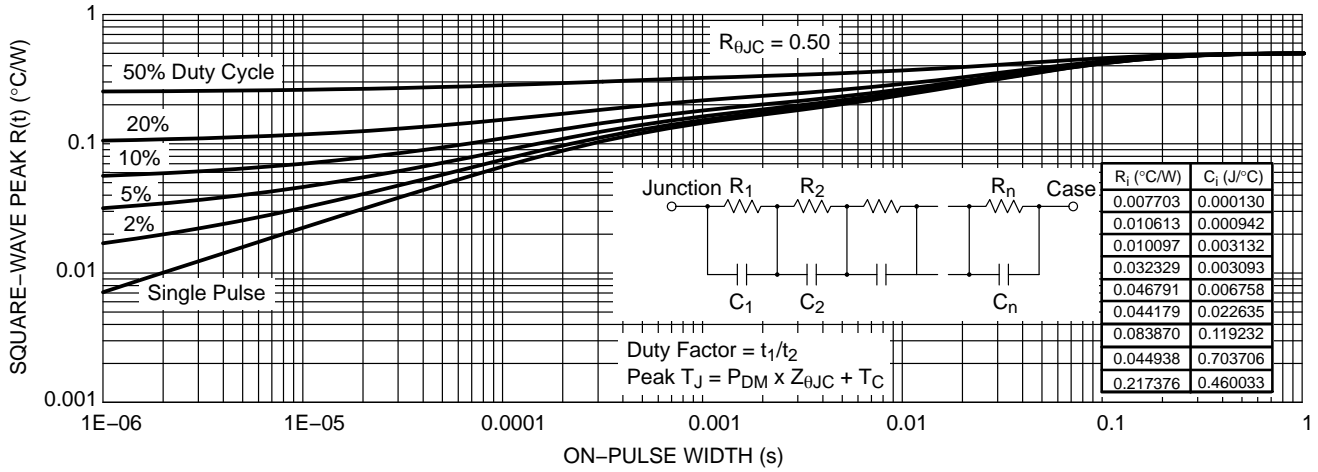

Figure 25. Diode Transient Thermal Impedance

NGTB40N120FL2WG

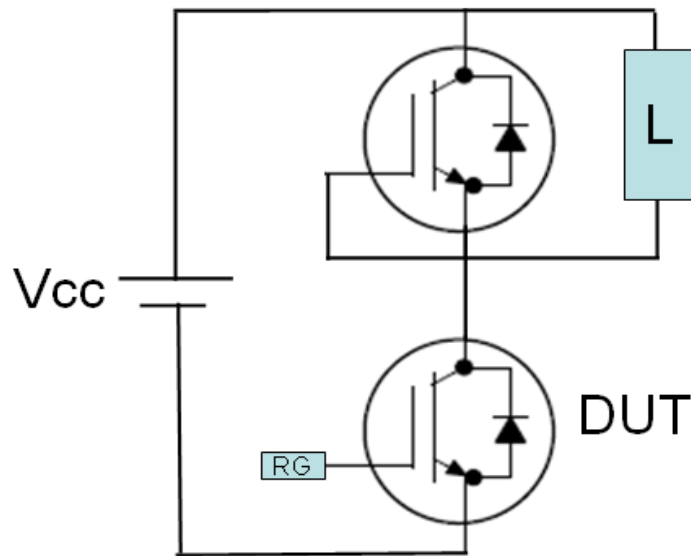

Figure 26. Test Circuit for Switching Characteristics

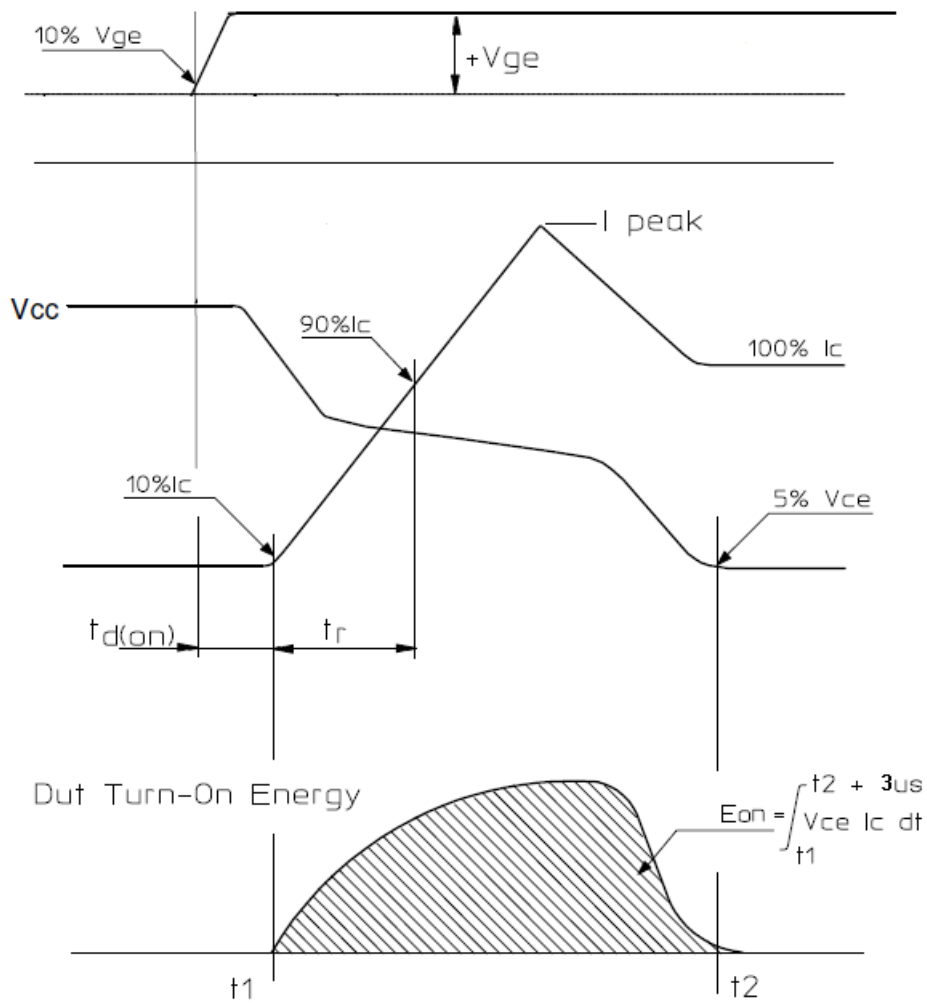

Figure 27. Definition of Turn On Waveform

NGTB40N120FL2WG

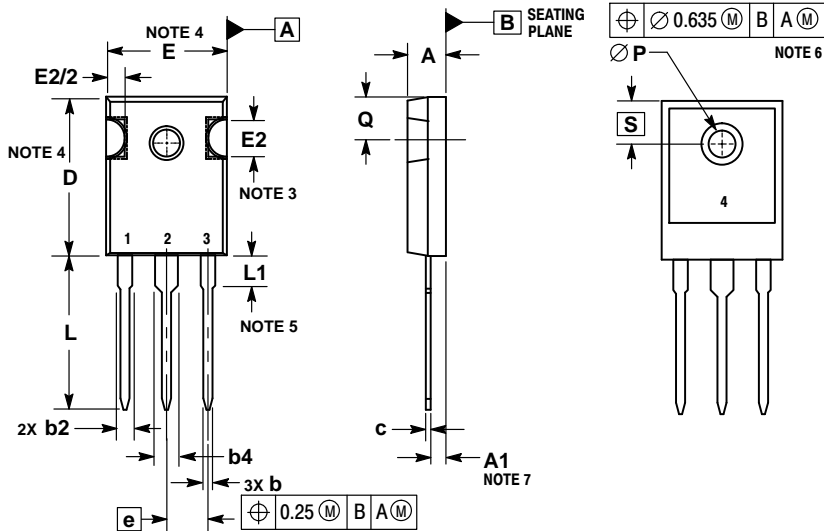

Figure 28. Definition of Turn Off Waveform

NGTB40N120FL2WG

PACKAGE DIMENSIONS

TO-247 CASE 340AL ISSUE A



NOTES:

1. DIMENSIONING AND TOLERANCING PER ASME Y14.5M, 1994.
2. CONTROLLING DIMENSION: MILLIMETERS.
3. SLOT REQUIRED, NOTCH MAY BE ROUNDED.
4. DIMENSIONS D AND E DO NOT INCLUDE MOLD FLASH. THESE DIMENSIONS ARE MEASURED AT THE OUTERMOST EXTREME OF THE PLASTIC BODY.
5. LEAD FINISH IS UNCONTROLLED IN THE REGION DEFINED BY L1.
6. $\varnothing P$ SHALL HAVE A MAXIMUM DRAFT ANGLE OF 1.5° TO THE TOP OF THE PART WITH A MAXIMUM DIAMETER OF 3.91.
7. DIMENSION A1 TO BE MEASURED IN THE REGION DEFINED BY L1.

| DIM | MILLIMETERS | |
|-----|-------------|-------|
| | MIN | MAX |
| A | 4.70 | 5.30 |
| A1 | 2.20 | 2.60 |
| b | 1.00 | 1.40 |
| b2 | 1.65 | 2.35 |
| b4 | 2.60 | 3.40 |
| c | 0.40 | 0.80 |
| D | 20.30 | 21.40 |
| E | 15.50 | 16.25 |
| E2 | 4.32 | 5.49 |
| e | 5.45 BSC | |
| L | 19.80 | 20.80 |
| L1 | 3.50 | 4.50 |
| P | 3.55 | 3.65 |
| Q | 5.40 | 6.20 |
| S | 6.15 BSC | |

ON Semiconductor and the  are registered trademarks of Semiconductor Components Industries, LLC (SCILLC) or its subsidiaries in the United States and/or other countries. SCILLC owns the rights to a number of patents, trademarks, copyrights, trade secrets, and other intellectual property. A listing of SCILLC's product/patent coverage may be accessed at www.onsemi.com/site/pdf/Patent-Marking.pdf. SCILLC reserves the right to make changes without further notice to any products herein. SCILLC makes no warranty, representation or guarantee regarding the suitability of its products for any particular purpose, nor does SCILLC assume any liability arising out of the application or use of any product or circuit, and specifically disclaims any and all liability, including without limitation special, consequential or incidental damages. "Typical" parameters which may be provided in SCILLC data sheets and/or specifications can and do vary in different applications and actual performance may vary over time. All operating parameters, including "Typicals" must be validated for each customer application by customer's technical experts. SCILLC does not convey any license under its patent rights nor the rights of others. SCILLC products are not designed, intended, or authorized for use as components in systems intended for surgical implant into the body, or other applications intended to support or sustain life, or for any other application in which the failure of the SCILLC product could create a situation where personal injury or death may occur. Should Buyer purchase or use SCILLC products for any such unintended or unauthorized application, Buyer shall indemnify and hold SCILLC and its officers, employees, subsidiaries, affiliates, and distributors harmless against all claims, costs, damages, and expenses, and reasonable attorney fees arising out of, directly or indirectly, any claim of personal injury or death associated with such unintended or unauthorized use, even if such claim alleges that SCILLC was negligent regarding the design or manufacture of the part. SCILLC is an Equal Opportunity/Affirmative Action Employer. This literature is subject to all applicable copyright laws and is not for resale in any manner.

PUBLICATION ORDERING INFORMATION

LITERATURE FULFILLMENT:

Literature Distribution Center for ON Semiconductor
P.O. Box 5163, Denver, Colorado 80217 USA
Phone: 303-675-2175 or 800-344-3860 Toll Free USA/Canada
Fax: 303-675-2176 or 800-344-3867 Toll Free USA/Canada
Email: orderlit@onsemi.com

N. American Technical Support: 800-282-9855 Toll Free
USA/Canada
Europe, Middle East and Africa Technical Support:
Phone: 421 33 790 2910
Japan Customer Focus Center
Phone: 81-3-5817-1050

ON Semiconductor Website: www.onsemi.com
Order Literature: <http://www.onsemi.com/orderlit>

For additional information, please contact your local Sales Representative