



UP56-212128

UP56

LEVEL SENSORS

SICK
Sensor Intelligence.



Illustration may differ



Ordering information

Type	Part no.
UP56-212128	6048701

Other models and accessories → www.sick.com/UP56

Detailed technical data

Features

Medium	Fluids
Measurement	Switch, Continuous
Measuring range in tank	85 mm ... 350 mm
Measuring range immersion tube	85 mm ... 1,500 mm ¹⁾
Process pressure	0 bar ... 6 bar, gauge pressure
Process temperature	-25 °C ... +70 °C

¹⁾ At 6 bar gauge.

Performance

Accuracy of sensor element	≤ 2 % ¹⁾
Repeatability	± 0.15 % ¹⁾
Resolution	≤ 0.18 mm
Response time	≤ 84 ms ²⁾

¹⁾ From the full scale value.

²⁾ Recovery time 32 ms ... 180 ms according to EMC EN 60947-5-7.

Electronics

Supply voltage	9 V DC ... 30 V DC, Switching output ¹⁾ 15 V DC ... 30 V DC, Analog output ¹⁾
Residual ripple	± 10 %
Power consumption	≤ 80 mA ²⁾
Electrical connection	Round connector M12 x 1, 5-pin
Output signal	1 x PNP + 4 mA ... 20 mA / 0 V ... 10 V ^{3) 4)}
Hysteresis	5 mm

¹⁾ Reverse-polarity protected.

²⁾ At 24 V DC without output load.

³⁾ Short-circuit protected, reversible.

⁴⁾ Automatic switching between voltage and current outputs dependet on load 4 mA ... 20 mA: RL ≤ 100 / at 9 V ≤ U_B ≤ 20 V; RL ≤ 500/ at U_B ≥ 20 V; 0 V ... 10 V: RL ≥ 100 k / at U_B ≥ 15 V, short-circuit protected.

Signal voltage HIGH	Uv -3 V
Time delay before availability	≤ 300 ms
Enclosure rating	IP 67
Ultrasonic frequency	320 kHz
Ultrasonic transducer	PTFE coating, FFKM

¹⁾ Reverse-polarity protected.

²⁾ At 24 V DC without output load.

³⁾ Short-circuit protected, reversible.

⁴⁾ Automatic switching between voltage and current outputs dependet on load 4 mA ... 20 mA: RL ≤ 100 / at 9 V ≤ U_B ≤ 20 V; RL ≤ 500/ at U_B ≥ 20 V; 0 V ... 10 V: RL ≥ 100 k / at U_B ≥ 15 V, short-circuit protected.

Mechanics

Process connection	G 1 A
Housing material	Stainless steel 1.4571
Weight	350 g

Ambient data

Ambient operating temperature	-25 °C ... +70 °C ¹⁾
Ambient storage temperature	-40 °C ... +85 °C

¹⁾ Temperature compensation at -25 °C ... +50 °C, can be switched off.

Classifications

ECl@ss 5.0	27200506
ECl@ss 5.1.4	27200506
ECl@ss 6.0	27200506
ECl@ss 6.2	27200506
ECl@ss 7.0	27200506
ECl@ss 8.0	27200506
ECl@ss 8.1	27200506
ECl@ss 9.0	27200506
ETIM 5.0	EC002654
ETIM 6.0	EC002654
UNSPSC 16.0901	41111950

Dimensional drawing (Dimensions in mm (inch))

UP56-211/ 212/ 213 all-metal

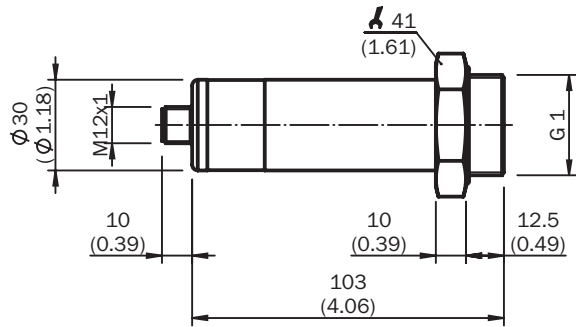

Connection diagram

1 x PNP + 4 mA ... 20 mA / 0 V ... 10 V

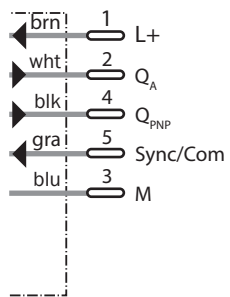

Connection type

Male connector M12, 5-pin



Scanning range

Detection range UP56-212118

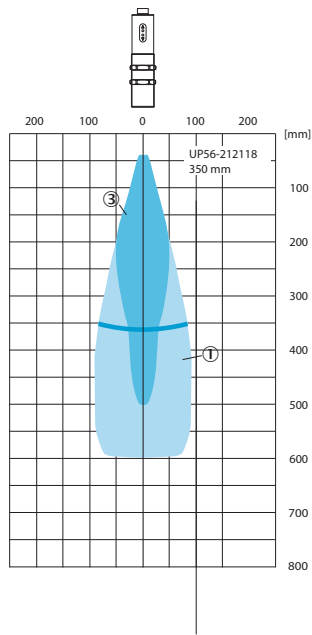









- ① Example object: aligned plate 500 mm x 500 mm
- ③ Pipe diameter 27 mm

Recommended accessories

Other models and accessories → www.sick.com/UP56

	Brief description	Type	Part no.
Flanges			
	Welded flange, process connection G 1, Stainless steel 1.4404	BEF-FL-316G10-UP56	4064295
	Welded flange/welded connector, process connection G 2, Stainless steel 1.4404	BEF-FL-316G20-UP56	4063263
Plug connectors and cables			
	Head A: female connector, M12, 5-pin, straight Head B: cable Cable: PVC, unshielded, 2 m	DOL-1205-G02M	6008899
	Head A: female connector, M12, 5-pin, straight Head B: cable Cable: drag chain use, PUR, halogen-free, unshielded, 2 m	DOL-1205-G02MC	6025906
	Head A: female connector, M12, 5-pin, straight Head B: cable Cable: PVC, unshielded, 5 m	DOL-1205-G05M	6009868
	Head A: female connector, M12, 5-pin, straight Head B: cable Cable: drag chain use, PUR, halogen-free, unshielded, 5 m	DOL-1205-G05MC	6025907

	Brief description	Type	Part no.
	Head A: female connector, M12, 5-pin, straight Head B: cable Cable: PVC, unshielded, 10 m	DOL-1205-G10M	6010544
	Head A: female connector, M12, 5-pin, straight Head B: cable Cable: drag chain use, PUR, halogen-free, unshielded, 10 m	DOL-1205-G10MC	6025908
	Head A: female connector, M12, 5-pin, angled Head B: cable Cable: PVC, unshielded, 2 m	DOL-1205-W02M	6008900
	Head A: female connector, M12, 5-pin, angled Head B: cable Cable: drag chain use, PUR, halogen-free, unshielded, 2 m	DOL-1205-W02MC	6025909
	Head A: female connector, M12, 5-pin, angled Head B: cable Cable: PVC, unshielded, 5 m	DOL-1205-W05M	6009869
	Head A: female connector, M12, 5-pin, angled Head B: cable Cable: drag chain use, PUR, halogen-free, unshielded, 5 m	DOL-1205-W05MC	6025910
	Head A: female connector, M12, 5-pin, angled Head B: cable Cable: PVC, unshielded, 10 m	DOL-1205-W10M	6010542
	Head A: female connector, M12, 5-pin, angled Head B: cable Cable: drag chain use, PUR, halogen-free, unshielded, 10 m	DOL-1205-W10MC	6025911
Programming and configuration tools			
	Tool for visualization, configuration and cloning, 3-digit LED display, supply voltage: DV 9 V ... 30 V	Connect+ adapter (CPA)	6037782

SICK AT A GLANCE

SICK is one of the leading manufacturers of intelligent sensors and sensor solutions for industrial applications. A unique range of products and services creates the perfect basis for controlling processes securely and efficiently, protecting individuals from accidents and preventing damage to the environment.

We have extensive experience in a wide range of industries and understand their processes and requirements. With intelligent sensors, we can deliver exactly what our customers need. In application centers in Europe, Asia and North America, system solutions are tested and optimized in accordance with customer specifications. All this makes us a reliable supplier and development partner.

Comprehensive services complete our offering: SICK LifeTime Services provide support throughout the machine life cycle and ensure safety and productivity.

For us, that is “Sensor Intelligence.”

WORLDWIDE PRESENCE:

Contacts and other locations –www.sick.com