

DESCRIPTION

The RH111 is a general purpose voltage comparator. The RH111 offers maximum input offset voltage of 3mV and input offset current of 10nA with a typical response time of 200ns. The RH111 can operate from a single 5V supply to $\pm 15V$ supplies and can drive up to 50mA loads referred to ground or either supply. A separate output Ground pin allows output signals to be isolated from analog ground.

The wafer lots are processed to the requirements of MIL-STD-883 Class S to yield circuits usable in precision space applications.

 LTC and LT are registered trademarks of Linear Technology Corporation.

ABSOLUTE MAXIMUM RATINGS

Supply Voltage (Pin 8 to Pin 4)	36V
Output to Negative Supply (Pin 7 to Pin 4)	35V
Ground to Negative Supply (Pin 1 to Pin 4)	30V
Differential Input Voltage	35V
Voltage at Strobe Pin (Pin 6 to Pin 8)	5V
Input Voltage (Note 1)	$\pm 15V$
Output Short-Circuit Duration	10 sec
Operating Temperature	
Range (Note 2)	$-55^{\circ}C$ to $125^{\circ}C$
Storage Temperature Range	$-65^{\circ}C$ to $150^{\circ}C$
Lead Temperature (Soldering, 10 sec)	$300^{\circ}C$

BURN-IN CIRCUIT

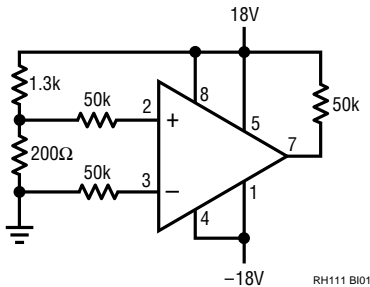

OR

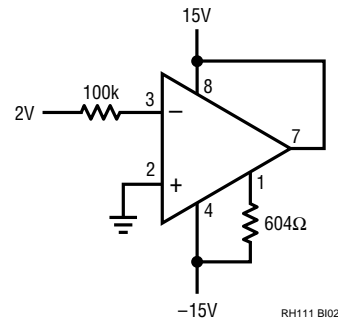

PACKAGE/ORDER INFORMATION

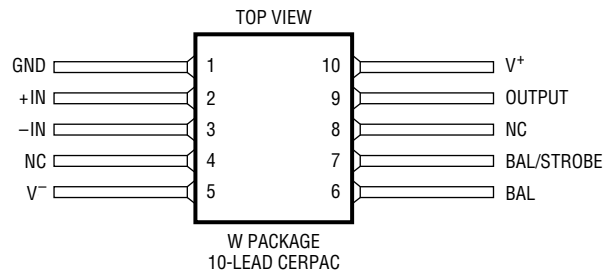
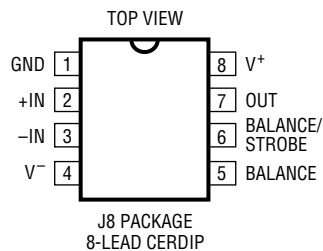
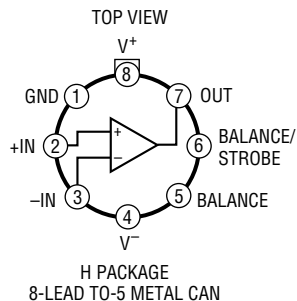

Note: For ordering information contact LTC.

TABLE 1: ELECTRICAL CHARACTERISTICS (Preirradiation) (Note 8)

SYMBOL	PARAMETER	CONDITIONS	NOTES	$T_A = 25^\circ\text{C}$			SUB-GROUP	$-55^\circ\text{C} \leq T_A \leq 125^\circ\text{C}$			SUB-GROUP	UNITS	
				MIN	TYP	MAX		MIN	TYP	MAX			
V_{OS}	Input Offset Voltage	$R_S \leq 50\text{k}$	3,4			3.0	1			4.0	2,3	mV	
I_{OS}	Input Offset Current		3,4			10	1			20	2,3	nA	
I_B	Input Bias Current		3			100	1			150	2,3	nA	
A_{VOL}	Large-Signal Voltage Gain		7		40		4					V/mV	
	Input Voltage Range	$V_S = \pm 15\text{V}, V_{PIN7} \leq 5\text{V}$			-14.5	13.0	1			-14.5	13.0	2,3	V
t_D	Response Time		5			200							ns
V_{OL}	Output Saturation Voltage	$V_{IN} = 5\text{mV}, I_{OUT} = 50\text{mA}, V^+ \geq 4.5\text{V}, V^- = 0\text{V}$				1.5	1						V
								0.4	1		0.4	2,3	V
	Output Leakage Current	$V_{IN} = 5\text{V}, I_{STROBE} = 3\text{mA}, V_{OUT} = 20\text{V}$				10	1			500	2,3	nA	
	Positive Supply Current					6.0	1					mA	
	Negative Supply Current					5.0	1					mA	
	Strobe Current	Minimum to Ensure Output Transistor Is Turned Off	6			3						mA	
	Input Capacitance					6						pF	

TABLE 1A: ELECTRICAL CHARACTERISTICS (Postirradiation) (Note 9)

SYMBOL	PARAMETER	CONDITIONS	NOTES	10KRAD(Si)		20KRAD(Si)		50KRAD(Si)		100KRAD(Si)		200KRAD(Si)		UNITS	
				MIN	MAX	MIN	MAX	MIN	MAX	MIN	MAX	MIN	MAX		
V_{OS}	Input Offset Voltage	$R_S \leq 50\text{k}$				3.0	3.0	3.0	3.0	3.0	3.0	4.0		mV	
I_{OS}	Input Offset Current					10	10	10	10	25	25	50		nA	
I_B	Input Bias Current					100	150	200	200	300	300	400		nA	
A_{VOL}	Large-Signal Voltage Gain		7		40	40	40	40	40	40	40	25		V/mV	
	Input Voltage Range	$V_S = \pm 15\text{V}, V_{PIN7} \leq 5\text{V}$			-14.5	13.0	-14.5	13.0	-14.5	13.0	-14.5	13.0	-14.5	13.0	V
V_{OL}	Output Saturation Voltage	$V_{IN} = 5\text{mV}, I_{OUT} = 50\text{mA}, V^+ \geq 4.5\text{V}, V^- = 0\text{V}$				1.5	1.5	1.5	1.5	1.5	1.5	1.5		V	
								0.4	0.4	0.4	0.4	0.4	0.4		V
	Output Leakage Current	$V_{IN} \geq 5\text{mV}, I_{STROBE} = 3\text{mA}, V_{OUT} = 20\text{V}$				10	10	100	100	100	100	100		nA	
	Positive Supply Current					6.0	6.0	6.0	6.0	6.0	6.0	6.0		mA	
	Negative Supply Current					5.0	5.0	5.0	5.0	5.0	5.0	5.0		mA	
	Strobe Current	Minimum to Ensure Output Transistor Is Turned Off	6			3 (Typ)	3(Typ)	3(Typ)	3(Typ)	3(Typ)	3(Typ)	3(Typ)		mA	
	Input Capacitance					6 (Typ)	6(Typ)	6(Typ)	6(Typ)	6(Typ)	6(Typ)	6(Typ)		pF	

Note 1: Applicable for $\pm 15\text{V}$ supplies. The positive input voltage limit is 30V above the negative supply. The negative input voltage limit is the negative supply.

Note 2: $T_{J\text{MAX}} = 150^\circ\text{C}$

Note 3: Offset voltage, offset current and bias current specifications apply for any supply voltage from a single 5V up to $\pm 15\text{V}$ supplies.

Note 4: Offset voltage and offset currents shown are the maximum values required to drive the output within a volt of either supply with a 1mA load. These parameters define an error band and take into account the worst-case effects of voltage gain and input impedance.

Note 5: Response time is specified for a 100mV input step with 5mV overdrive with the collector output terminated with a 500 Ω pull-up resistor tied to 5V.

Note 6: Do not short the Strobe pin to ground. It should be current driven at 3mA to 5mA for the shortest strobe time. Currents as low as 500 μA will strobe the RH111 if speed is not important. External leakage on the Strobe pin in excess of 0.2 μA when the strobe is "off" can cause offset voltage shifts.

Note 7: $R_L = 1\text{k}$, $-10\text{V} \leq V_{\text{OUT}} \leq 14.5\text{V}$

Note 8: $V_S = \pm 15\text{V}$, unless otherwise noted.

Note 9: $V_S = \pm 15\text{V}$, $V_{\text{CM}} = 0\text{V}$, $T_A = 25^\circ\text{C}$, unless otherwise noted.

TOTAL DOSE BIAS CIRCUIT

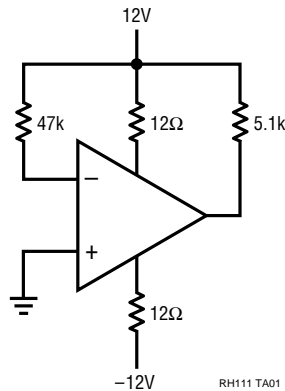

TABLE 2: ELECTRICAL TEST REQUIREMENTS

MIL-STD-883 TEST REQUIREMENTS	SUBGROUP
Final Electrical Test Requirements (Method 5004)	1*,2,3,4
Group A Test Requirements (Method 5005)	1,2,3,4
Group C and D End Point Electrical Parameters (Method 5005)	1

* PDA Applies to subgroup 1. See PDA Test Notes.

PDA Test Notes

The PDA is specified as 5% based on failures from group A, subgroup 1, tests after cooldown as the final electrical test in accordance with method 5004 of MIL-STD-883 Class B. The verified failures of group A, subgroup 1, after burn-in divided by the total number of devices submitted for burn-in in that lot shall be used to determine the percent for the lot.

Linear Technology Corporation reserves the right to test to tighter limits than those given.

TYPICAL PERFORMANCE CHARACTERISTICS

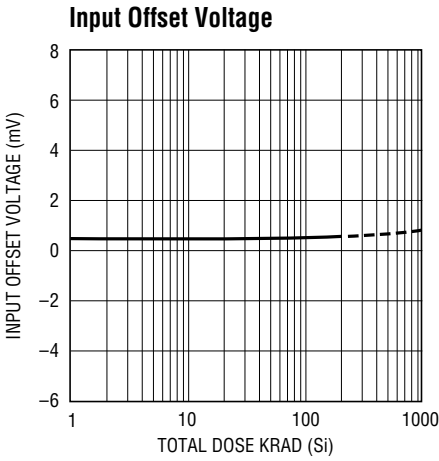

RH111 G01

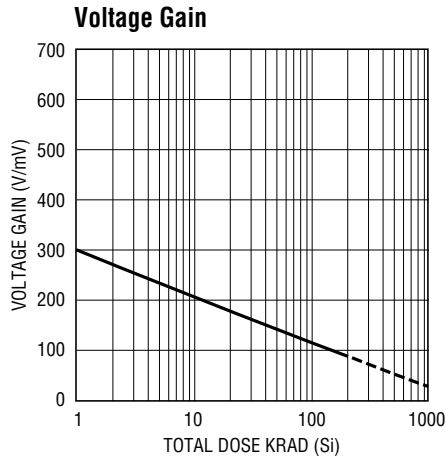

RH111 G02

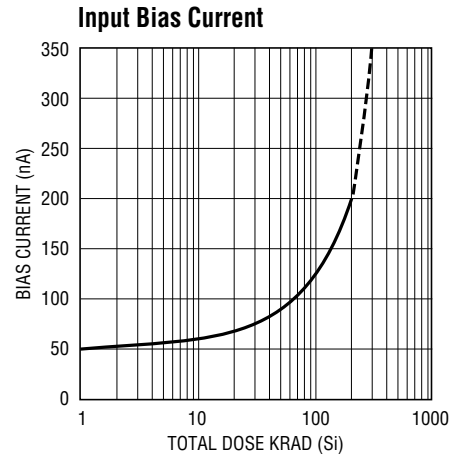

RH111 G03

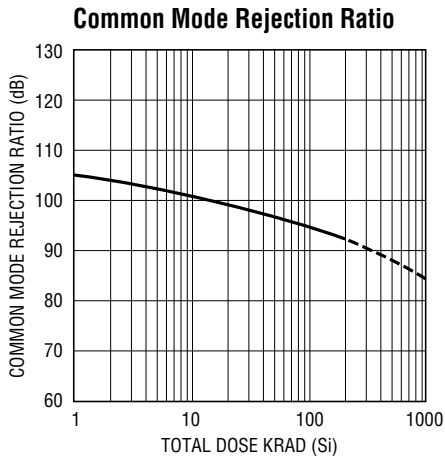

RH111 G04

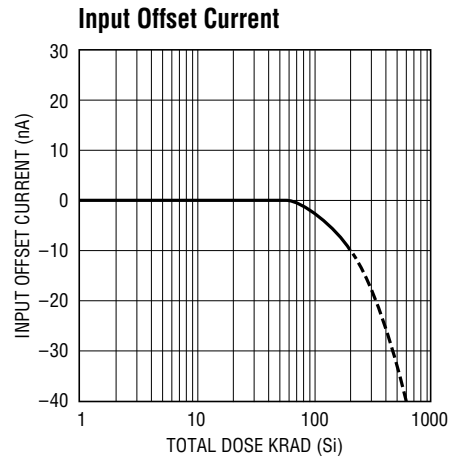

RH111 G05