



## Connection cable V1-W-1M-PVC-V1-G

- Degree of protection IP68 / IP69
- Specific design protects against loosening and inaccurate installation

Cordset M12 socket angled to M12 plug straight A-coded, 4-pin, PVC cable grey



### Dimensions

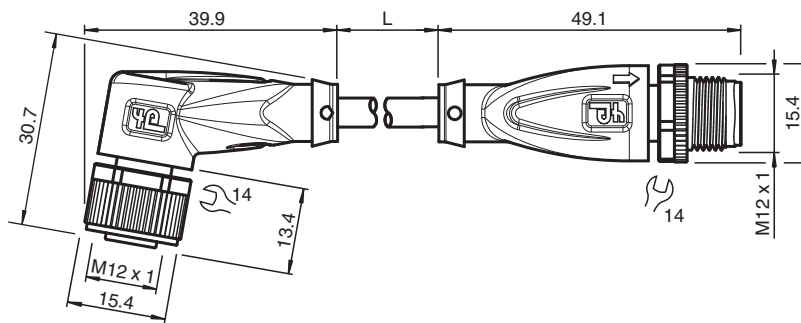

### Technical Data

#### General specifications

Connector 1		
Connection		socket
Construction type		M12
Style		angled
Locking		screw connection
Number of pins		4
Coding		A-coded
Connector 2		
Connection		plug
Construction type		M12
Style		straight
Locking		screw connection
Number of pins		4
Coding		A-coded
<b>Electrical specifications</b>		
Operating voltage	$U_B$	max. 250 V AC/DC

Release date: 2022-03-13 Date of issue: 2022-03-13 Filename: 114705\_eng.pdf

Refer to "General Notes Relating to Pepperl+Fuchs Product Information".

Pepperl+Fuchs Group  
www.pepperl-fuchs.com

USA: +1 330 486 0001  
fa-info@us.pepperl-fuchs.com

Germany: +49 621 776 1111  
fa-info@de.pepperl-fuchs.com

Singapore: +65 6779 9091  
fa-info@sg.pepperl-fuchs.com

PEPPERL+FUCHS





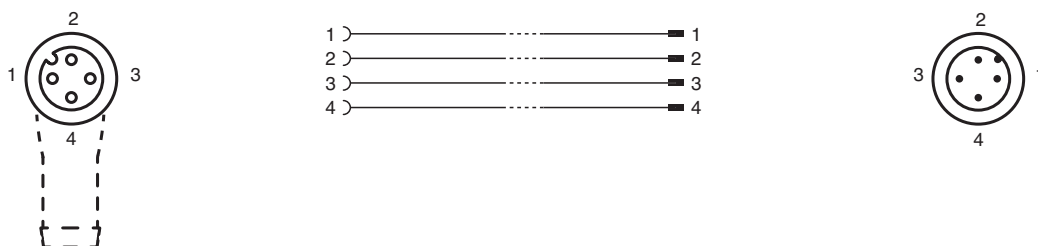

## Technical Data

Operating current	$I_B$	max. 4 A
<b>Conformity</b>		
Degree of protection		EN 60529
Plug connection		connector M12 x 1 : IEC 61076-2-101
Flammability		IEC 60332-2-2
<b>Ambient conditions</b>		
Ambient temperature		
Plug connector		-40 ... 90 °C (-40 ... 194 °F)
Cable, fixed		-25 ... 70 °C (-13 ... 158 °F)
Cable, flexing		-5 ... 70 °C (23 ... 158 °F)
Pollution degree		3
<b>Mechanical specifications</b>		
Plug connector		
Tightening torque		0.6 Nm
Loosening protection		available
Tool installation		straight knurling and hexagon nut SW = 14 mm
Mating cycles		min. 100
Degree of protection		IP68 / IP69
Cable		
Sheath diameter		4.8 mm
Bending radius		> 10 x cable diameter, moving
Sheath stripping force		max. 80 N / 300 mm
Sheath color		grey (similar to RAL 7001)
Number of cores		4
Core cross section		0.34 mm <sup>2</sup>
Cores color		Core 1: brown Core 2: white Core 3: blue Core 4: black
Core construction		19 x 0.15 mm Ø
Length	L	1 m
Cable code		Li Y YM 4 x 0,34
<b>Material</b>		
Plug connector		
Screw connection		Zinc diecast, nickel-plated
Body		TPU, black
Seal		FKM
Contact surface		Au
Flammability		V-2
Cable		
Sheathing		PVC
Core insulation		PVC
Flammability		flame-resistant

## Connection Assignment



**Accessories**

	<b>MH V1-SCREWDRIVER</b>	torque screwdriver (0.6 Nm)
	<b>MH V1-BIT M12</b>	plug-in cap M12
	<b>V1/V3-LABELHOLDER</b>	Label holder
	<b>V1/V3-LABEL</b>	Label plate
	<b>MH V1-Holder</b>	Modular universal holder for M12 connectors
	<b>V1-CLIP</b>	Unlocking protector for M12 connector
	<b>V1-MARKING-RING-COLOR</b>	Marking rings for M12 connectors, various colors

Release date: 2022-03-13 Date of issue: 2022-03-13 Filename: 114705\_eng.pdf

Refer to "General Notes Relating to Pepperl+Fuchs Product Information".

Pepperl+Fuchs Group  
www.pepperl-fuchs.com

USA: +1 330 486 0001  
fa-info@us.pepperl-fuchs.com

Germany: +49 621 776 1111  
fa-info@de.pepperl-fuchs.com

Singapore: +65 6779 9091  
fa-info@sg.pepperl-fuchs.com