

**KEMET Part Number: SC-07-90J**  
(UALSC0790J0000)

KEMET, SC-J, AC Line Filters, Common Mode, 9000  $\mu$ H

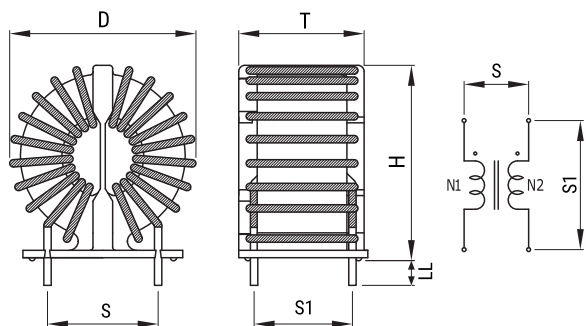

#### Dimensions

<b>D</b>	34mm MAX
<b>T</b>	23mm MAX
<b>H</b>	33mm MAX
<b>LL</b>	5mm +/-2mm
<b>S</b>	18mm NOM

#### Packaging Specifications

<b>Packaging:</b>	Tray
<b>Packaging Quantity:</b>	200
<b>Weight:</b>	45.8 g

#### General Information

<b>Series:</b>	SC-J
<b>Style:</b>	Through-Hole
<b>RoHS:</b>	Yes
<b>Notes:</b>	Lead Spacing (S/S1) Are For Reference Only.
<b>Miscellaneous:</b>	Temperature Rise Maximum: 85 K

#### Specifications

<b>Voltage AC:</b>	250 VAC
<b>Inductance:</b>	9 mH (10 kHz)
<b>Current:</b>	7 A
<b>Temperature Range:</b>	-25/+120°C
<b>DC Resistance:</b>	50 mOhms