

# HETERO JUNCTION FIELD EFFECT TRANSISTOR NE4210M01

### C to Ku BAND SUPER LOW NOISE AMPLIFIER N-CHANNEL HJ-FET

#### DESCRIPTION

The NE4210M01 is a Hetero Junction FET that utilizes the hetero junction to create high mobility electrons. Its excellent low noise and high associated gain make it suitable for DBS, TVRO and another commercial systems.

#### FEATURES

- Super Low Noise Figure & High Associated Gain  
NF = 0.8 dB TYP.,  $G_a = 11$  dB TYP. at  $f = 12$  GHz
- 6pin super minimold package
- Gate Width:  $W_g = 200\mu\text{m}$

#### ORDERING INFORMATION

Part Number	Package	Supplying Form	Marking
NE4210M01-T1	6-pin super minimold	Embossed tape 8 mm wide. 1, 2, 3 pins face to perforation side of the tape	V73

#### ABSOLUTE MAXIMUM RATINGS ( $T_A = 25^\circ\text{C}$ )

Parameter	Symbol	Ratings	Unit
Drain to Source Voltage	$V_{DS}$	4.0	V
Gate to Source Voltage	$V_{GS}$	-3.0	V
Drain Current	$I_D$	$I_{DSS}$	mA
Gate Current	$I_G$	100	$\mu\text{A}$
Total Power Dissipation	$P_{tot}$	125	mW
Channel Temperature	$T_{ch}$	125	$^\circ\text{C}$
Storage Temperature	$T_{stg}$	-65 to +125	$^\circ\text{C}$

The information in this document is subject to change without notice.

**RECOMMENDED OPERATING CONDITION (T<sub>A</sub> = 25 °C)**

Characteristic	Symbol	MIN.	TYP.	MAX.	Unit
Drain to Source Voltage	V <sub>DS</sub>		2	3	V
Drain Current	I <sub>D</sub>		10	20	mA
Input Power	P <sub>in</sub>			+5	dBm

**ELECTRICAL CHARACTERISTICS (T<sub>A</sub> = 25 °C)**

Parameter	Symbol	Test Conditions	MIN.	TYP.	MAX.	Unit
Gate to Source Leak Current	I <sub>GSO</sub>	V <sub>GS</sub> = -3 V		0.5	10	μA
Saturated Drain Current	I <sub>DSS</sub>	V <sub>DS</sub> = 2 V, V <sub>GS</sub> = 0 V	20	60	90	mA
Gate to Source Cutoff Voltage	V <sub>GS(off)</sub>	V <sub>DS</sub> = 2 V, I <sub>D</sub> = 100 μA	-0.2	-0.7	-2.0	V
Transconductance	g <sub>m</sub>	V <sub>DS</sub> = 2 V, I <sub>D</sub> = 10 mA	50	65		mS
Noise Figuer	NF	f = 12 GHz	V <sub>DS</sub> = 2 V I <sub>D</sub> = 10 mA	0.8	1.1	dB
		f = 4 GHz		0.4		
Associated Gain	G <sub>a</sub>	f = 12 GHz		9.0	11.0	dB
		f = 4 GHz			16.0	

PACKAGE DIMENSIONS

6 pin super minimold (Unit: mm)

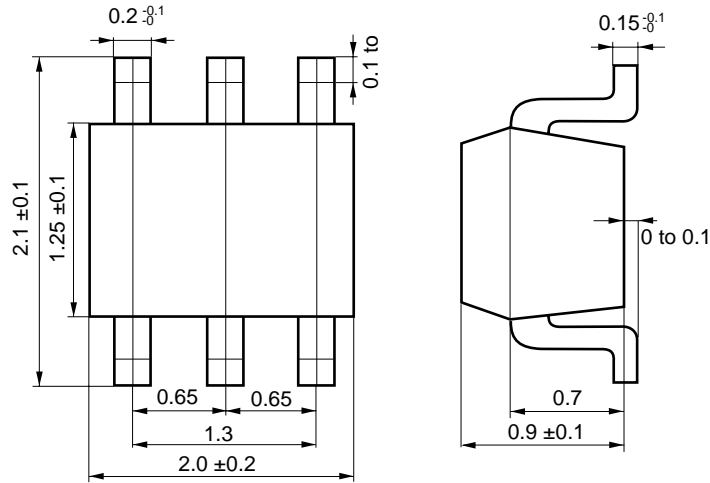

PIN CONNECTIONS

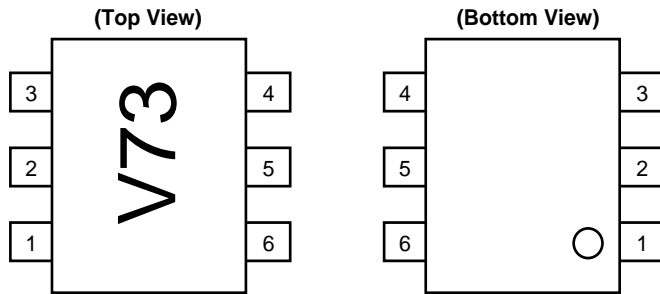

Pin No.	Pin Name
1	Gate
2	Source
3	Source
4	Drain
5	Source
6	Source

TYPICAL CHARACTERISTICS (T<sub>A</sub> = 25 °C)

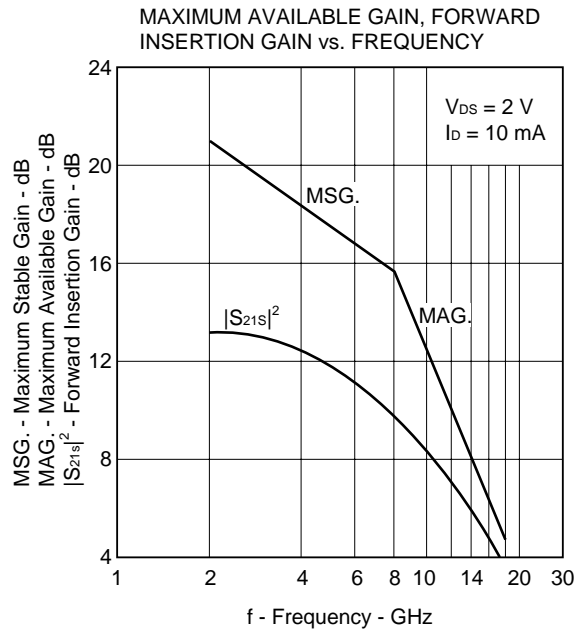
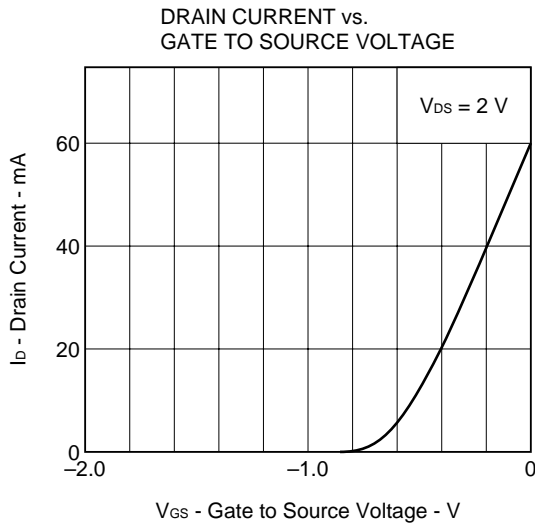
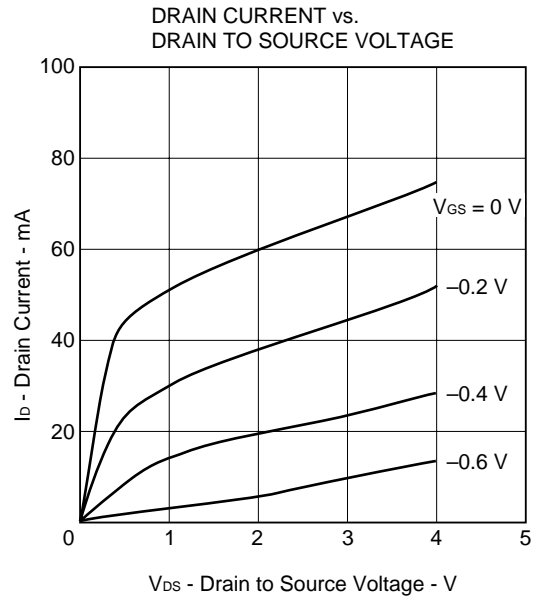
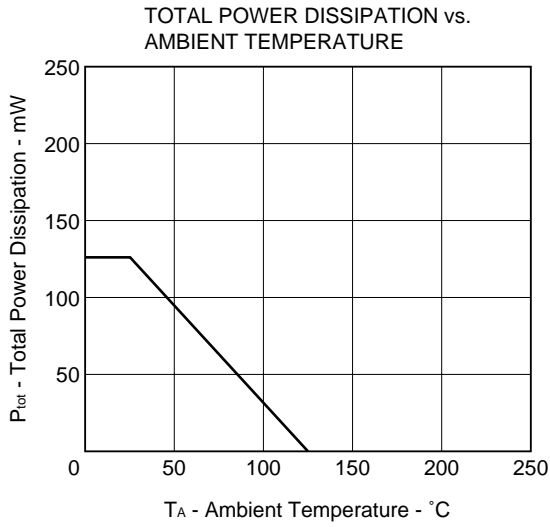

Gain Calculations

$$MSG = \frac{|S_{21}|}{|S_{12}|}$$

$$K = \frac{1 + |\Delta|^2 - |S_{11}|^2 - |S_{22}|^2}{2 |S_{12}| |S_{21}|}$$

$$MAG = \frac{|S_{21}|}{|S_{12}|} (K \pm \sqrt{K^2 - 1})$$

$$\Delta = S_{11} \cdot S_{22} - S_{21} \cdot S_{12}$$

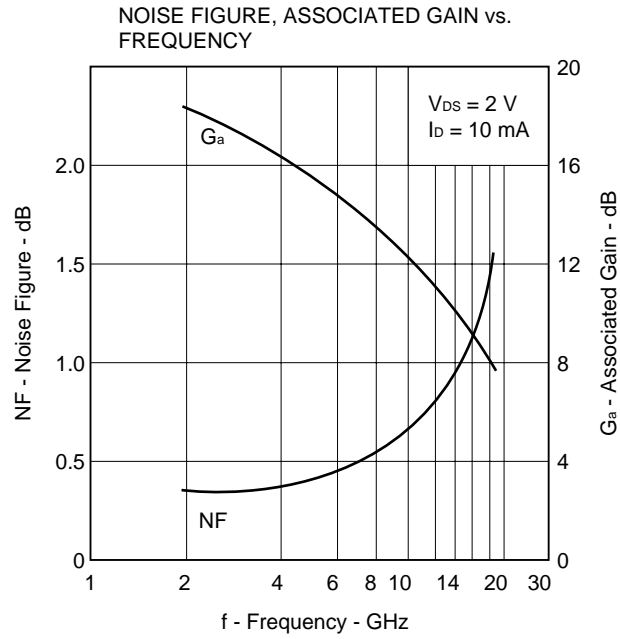

S-PARAMETER

MAG. AND ANG.

$V_{DS} = 2\text{ V}$ ,  $I_D = 10\text{ mA}$

FREQUENCY MHz	S <sub>11</sub>		S <sub>21</sub>		S <sub>12</sub>		S <sub>22</sub>	
	MAG.	ANG. (deg.)	MAG.	ANG. (deg.)	MAG.	ANG. (deg.)	MAG.	ANG. (deg.)
500	.991	-10.4	4.511	169.7	.011	85.4	.657	-8.4
1000	.992	-20.7	4.520	159.7	.021	74.5	.652	-16.9
1500	.991	-31.0	4.523	149.2	.032	69.3	.648	-25.2
2000	.948	-42.3	4.439	136.4	.041	58.9	.610	-31.8
2500	.926	-53.4	4.392	125.5	.050	51.3	.592	-40.6
3000	.893	-64.5	4.318	114.5	.058	42.9	.565	-49.3
3500	.859	-74.8	4.215	104.1	.064	36.5	.545	-57.0
4000	.829	-85.0	4.104	94.2	.070	29.0	.524	-64.6
4500	.798	-93.5	3.997	84.9	.074	22.1	.507	-71.7
5000	.769	-102.4	3.926	75.7	.078	15.9	.493	-78.5
5500	.738	-111.5	3.876	66.5	.082	9.3	.472	-85.2
6000	.679	-116.9	3.847	59.7	.085	5.7	.458	-87.3
6500	.667	-130.4	3.845	49.0	.091	-1.8	.415	-95.9
7000	.641	-144.4	3.817	38.5	.094	-8.6	.373	-105.7
7500	.615	-158.6	3.831	27.2	.099	-16.7	.349	-115.0
8000	.584	-173.6	3.776	16.0	.102	-25.4	.312	-126.4
8500	.553	172.1	3.692	5.0	.103	-33.8	.270	-139.3
9000	.530	157.4	3.603	-5.8	.103	-40.5	.235	-152.6
9500	.507	142.4	3.510	-16.9	.103	-48.3	.209	-165.6
10000	.484	126.9	3.408	-28.0	.103	-56.2	.171	177.0
10500	.482	110.3	3.270	-38.7	.103	-64.0	.139	160.7
11000	.487	92.5	3.176	-49.0	.101	-72.2	.142	133.6
11500	.536	73.8	3.109	-59.7	.100	-78.2	.164	114.7
12000	.562	52.8	3.085	-70.0	.102	-86.5	.173	103.7
12500	.617	37.3	2.994	-83.7	.101	-97.5	.173	81.1
13000	.604	21.9	2.744	-95.6	.096	-106.1	.186	44.2
13500	.602	14.7	2.534	-106.8	.090	-114.9	.240	18.9
14000	.625	4.6	2.361	-117.9	.085	-121.8	.299	11.5
14500	.647	-5.6	2.208	-128.8	.087	-129.4	.342	7.0
15000	.667	-15.3	2.034	-138.9	.085	-139.0	.373	-0.1
15500	.683	-23.9	1.926	-148.4	.080	-148.7	.391	-5.5
16000	.714	-32.6	1.808	-160.0	.076	-153.4	.435	-8.3
16500	.739	-41.9	1.649	-170.7	.079	-161.1	.471	-15.9
17000	.765	-48.5	1.535	178.1	.075	-170.4	.509	-25.0
17500	.788	-56.1	1.372	165.7	.078	179.9	.552	-35.3
18000	.808	-62.6	1.177	155.3	.069	173.2	.580	-46.4

**AMP. PARAMETERS**

$V_{DS} = 2\text{ V}$ ,  $I_D = 10\text{ mA}$

FREQUENCY MHz	GUmax dB	GAmax dB	S <sub>21</sub>   <sup>2</sup> dB	S <sub>12</sub>   <sup>2</sup> dB	K	Delay ns	Mason's U dB	G1 dB	G2 dB
500	33.06		13.09	-39.20	.08	.056		17.52	2.46
1000	33.41		13.10	-33.38	.08	.056		17.91	2.40
1500	33.04		13.11	-30.02	.05	.058		17.57	2.36
2000	24.87		12.95	-27.78	.27	.071	29.694	9.91	2.02
2500	23.16		12.85	-26.03	.31	.060	30.116	8.43	1.88
3000	21.30		12.71	-24.80	.39	.061	26.913	6.93	1.67
3500	19.84		12.50	-23.86	.46	.057	26.284	5.82	1.53
4000	18.70		12.26	-23.15	.52	.055	24.591	5.04	1.40
4500	17.73		12.03	-22.64	.59	.052	23.052	4.41	1.29
5000	16.98		11.88	-22.20	.64	.051	22.477	3.89	1.21
5500	16.28		11.77	-21.70	.70	.051	21.636	3.42	1.10
6000	15.40		11.70	-21.36	.82	.038	19.846	2.68	1.02
6500	15.07		11.70	-20.80	.81	.059	20.495	2.55	.82
7000	14.59		11.63	-20.51	.84	.058	20.840	2.30	.65
7500	14.29		11.67	-20.09	.86	.063	21.341	2.06	.56
8000	13.80		11.54	-19.83	.90	.062	20.755	1.81	.45
8500	13.26		11.35	-19.72	.96	.061	19.703	1.59	.33
9000	12.81	14.49	11.13	-19.77	1.02	.060	19.158	1.43	.25
9500	12.39	13.55	10.91	-19.75	1.08	.062	18.458	1.29	.19
10000	11.94	12.77	10.65	-19.73	1.16	.062	17.507	1.16	.13
10500	11.53	12.18	10.29	-19.76	1.22	.059	16.739	1.15	.09
11000	11.30	11.92	10.04	-19.94	1.26	.057	16.388	1.18	.09
11500	11.44	12.24	9.85	-19.96	1.19	.060	17.722	1.47	.12
12000	11.56	12.49	9.79	-19.83	1.15	.057	18.798	1.65	.13
12500	11.74	12.86	9.53	-19.96	1.10	.076	20.502	2.08	.13
13000	10.90	11.29	8.77	-20.34	1.30	.066	16.279	1.98	.15
13500	10.29	10.44	8.08	-20.92	1.47	.062	14.380	1.95	.26
14000	10.02	10.15	7.46	-21.39	1.52	.061	13.882	2.16	.41
14500	9.78	9.97	6.88	-21.24	1.48	.060	13.926	2.36	.54
15000	9.37	9.60	6.17	-21.43	1.50	.056	13.389	2.55	.65
15500	9.14	9.43	5.70	-21.90	1.55	.053	13.022	2.73	.72
16000	9.15	9.57	5.14	-22.40	1.50	.065	13.301	3.09	.91
16500	8.86	9.44	4.35	-22.09	1.40	.059	13.591	3.43	1.09
17000	8.85	9.67	3.72	-22.44	1.32	.062	14.276	3.82	1.30
17500	8.54	9.84	2.75	-22.19	1.19	.069	15.550	4.22	1.58
18000	7.78	8.72	1.42	-23.28	1.37	.058	12.630	4.58	1.78

**NOISE PARAMETER**

$V_{DS} = 2\text{ V}$ ,  $I_D = 10\text{ mA}$

Freq. (GHz)	NFmin. (dB)	Ga (dB)	$\Gamma_{opt.}$		Rn/50
			MAG.	ANG. (deg.)	
2.0	0.38	18.2	0.82	37	0.36
4.0	0.39	16.3	0.64	67	0.26
6.0	0.47	14.6	0.48	101	0.17
8.0	0.56	13.5	0.38	142	0.09
10.0	0.66	12.3	0.25	-167	0.09
12.0	0.80	11.0	0.24	-92	0.15
14.0	0.94	10.0	0.42	-12	0.39
16.0	1.19	9.2	0.58	30	0.71
18.0	1.48	8.0	0.66	66	1.18



**RECOMMENDED SOLDERING CONDITIONS**

This product should be soldered under the following recommended conditions. For soldering methods and conditions other than those recommended below, contact your NEC sales representative.

Soldering Method	Soldering Conditions	Recommended Condition Symbol
Infrared Reflow	Package peak temperature: 230 °C or below Time: 30 seconds or less (at 210 °C) Count: 2, Exposure limit <sup>Note</sup> : None	IR30-00-2
VPS	Package peak temperature: 215 °C or below Time: 40 seconds or less (at 200 °C) Count: 2, Exposure limit <sup>Note</sup> : None	VP15-00-2
Wave Soldering	Soldering bath temperature: 260 °C or below Time: 10 seconds or less Count: 1, Exposure limit <sup>Note</sup> : None	WS60-00-1
Partial Heating	Pin temperature: 230 °C Time: 10 seconds or less (per pin row) Exposure limit <sup>Note</sup> : None	—

**Note** After opening the dry pack, keep it in a place below 25 °C and 65 % RH for the allowable storage period.

**Caution** Do not use different soldering methods together (except for partial heating).

**PRECAUTION** Avoid high static voltage and electric fields, because this device is Hetero Junction field effect transistor with shottky barrier gate.

For more details, refer to our document “SEMICONDUCTOR DEVICE MOUNTING TECHNOLOGY MANUAL” (C10535E).

[MEMO]

[MEMO]

## CAUTION

**The Great Care must be taken in dealing with the devices in this guide.**

**The reason is that the material of the devices is GaAs (Gallium Arsenide), which is designated as harmful substance according to the law concerned.**

**Keep the law concerned and so on, especially in case of removal.**

No part of this document may be copied or reproduced in any form or by any means without the prior written consent of NEC Corporation. NEC Corporation assumes no responsibility for any errors which may appear in this document.

NEC Corporation does not assume any liability for infringement of patents, copyrights or other intellectual property rights of third parties by or arising from use of a device described herein or any other liability arising from use of such device. No license, either express, implied or otherwise, is granted under any patents, copyrights or other intellectual property rights of NEC Corporation or others.

While NEC Corporation has been making continuous effort to enhance the reliability of its semiconductor devices, the possibility of defects cannot be eliminated entirely. To minimize risks of damage or injury to persons or property arising from a defect in an NEC semiconductor device, customers must incorporate sufficient safety measures in its design, such as redundancy, fire-containment, and anti-failure features.

NEC devices are classified into the following three quality grades:

"Standard", "Special", and "Specific". The Specific quality grade applies only to devices developed based on a customer designated "quality assurance program" for a specific application. The recommended applications of a device depend on its quality grade, as indicated below. Customers must check the quality grade of each device before using it in a particular application.

Standard: Computers, office equipment, communications equipment, test and measurement equipment, audio and visual equipment, home electronic appliances, machine tools, personal electronic equipment and industrial robots

Special: Transportation equipment (automobiles, trains, ships, etc.), traffic control systems, anti-disaster systems, anti-crime systems, safety equipment and medical equipment (not specifically designed for life support)

Specific: Aircrafts, aerospace equipment, submersible repeaters, nuclear reactor control systems, life support systems or medical equipment for life support, etc.

The quality grade of NEC devices is "Standard" unless otherwise specified in NEC's Data Sheets or Data Books. If customers intend to use NEC devices for applications other than those specified for Standard quality grade, they should contact an NEC sales representative in advance.

Anti-radioactive design is not implemented in this product.