

InGaAs PIN photodiode G8422/G8372/G5852 series

Long wavelength type (up to 2.1 μm)

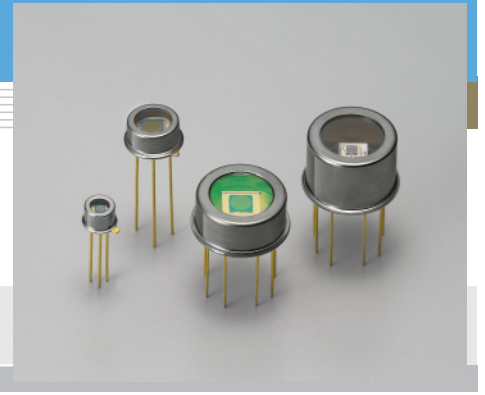

Features

- Cut-off wavelength: 2.1 μm
- 3-pin TO-18 package: low price
- TE-cooled type TO-8 package: low dark current
- Active area: $\phi 0.3$ to $\phi 3$ mm

Applications

- Gas analyzer
- Water content analyzer
- NIR (Near Infrared) photometry

Specifications / Absolute maximum ratings

Type No.	Dimensional outline	Package	Cooling	Active area (mm)	Absolute maximum ratings				
					Thermistor power dissipation (mW)	TE-cooler allowable current (A)	Reverse voltage V_R (V)	Operating temperature T_{opr} ($^{\circ}\text{C}$)	Storage temperature T_{stg} ($^{\circ}\text{C}$)
G8422-03	①	TO-18	Non-cooled	$\phi 0.3$	-	-	-	-40 to +85	-55 to +125
G8422-05				$\phi 0.5$					
G8372-01				$\phi 1$					
G8372-03				$\phi 3$					
G5852-103	③	TO-8	One-stage TE-cooled	$\phi 0.3$	0.2	1.5	2	-40 to +70	-55 to +85
G5852-11				$\phi 1$					
G5852-13				$\phi 3$					
G5852-203				$\phi 0.3$					
G5852-21	④	TO-8	Two-stage TE-cooled	$\phi 0.3$	0.2	1.0	-	-	-
G5852-23				$\phi 1$					
G5852-23				$\phi 3$					

Electrical and optical characteristics (Typ. unless otherwise noted)

Type No.	Measurement condition	Spectral response range λ (μm)	Peak sensitivity wavelength λ_p (μm)	Photo sensitivity $S_{\lambda=\lambda_p}$ (A/W)	Dark current I_D ($V_R=1$ V)		Cut-off frequency f_c ($V_R=1$ V, $R_L=50$ Ω) (MHz)	Terminal capacitance C_t ($V_R=1$ V, $f=1$ MHz) (pF)	Shunt resistance R_{sh} ($V_R=10$ mV) (M Ω)	D^* $\lambda=\lambda_p$ (cm \cdot Hz $^{1/2}$ /W)	NEP $\lambda=\lambda_p$ (W/Hz $^{1/2}$)	
	Element Temperature T ($^{\circ}\text{C}$)				Typ. (nA)	Max. (nA)						
	G8422-03				25	0.9 to 2.1						1.95
G8422-05		125	1250	80	20		0.3	2.5×10^{-13}				
G8372-01		500	5000	40	80		0.1	4×10^{-13}				
G8372-03		5 (μA)	50 (μA)	3	800		0.01	1.5×10^{-12}				
G5852-103	-10	0.9 to 2.07	1.95	1.2	5.5	55	100	8	9	8×10^{11}	5×10^{-14}	
G5852-11						50	500	40	80		1	1×10^{-13}
G5852-13						500	5000	3	800		0.1	4×10^{-13}
G5852-203	-20	0.9 to 2.05	1.95	1.2	3	30	100	8	18	1.2×10^{12}	3×10^{-14}	
G5852-21						25	250	40	80		2	8×10^{-14}
G5852-23						250	2500	3	800		0.2	3×10^{-13}

■ Spectral response

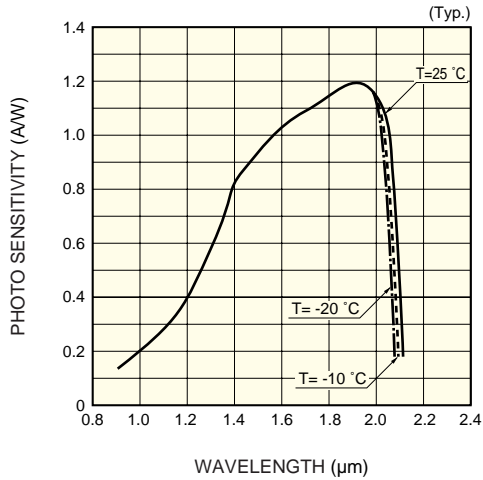

KIRDB0226EA

■ Photo sensitivity temperature characteristic

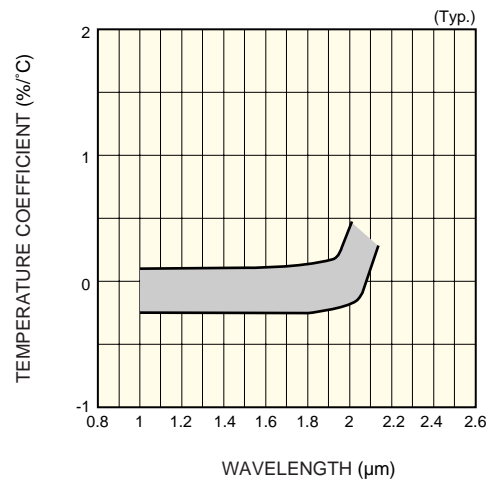

KIRDB0207EA

■ Dark current vs. reverse voltage

Non-cooled type

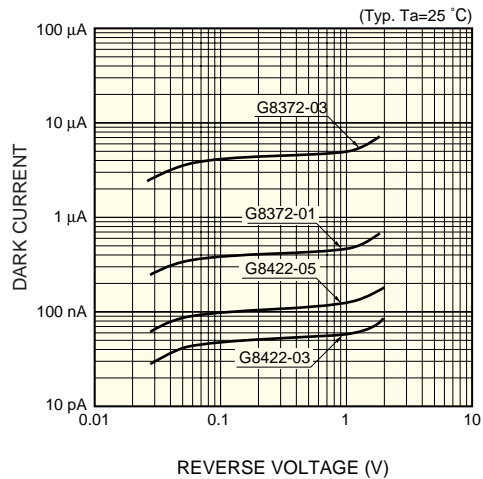

KIRDB0235EA

TE-cooled type

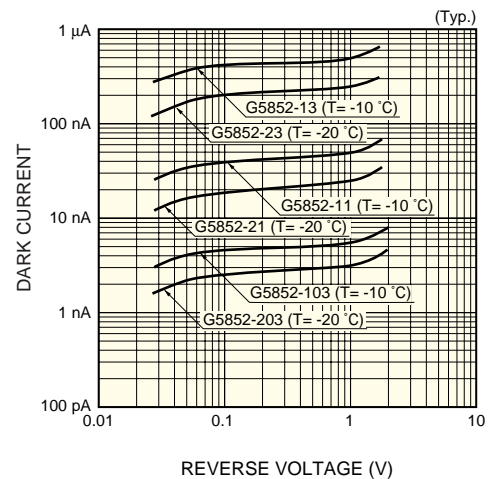

KIRDB0228EA

■ Terminal capacitance vs. reverse voltage

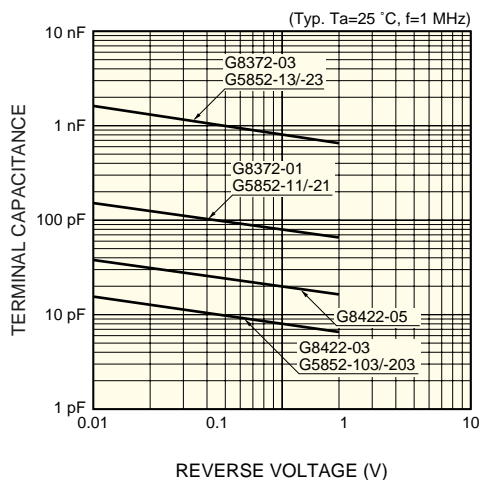

KIRDB0236EA

■ Shunt resistance vs. element temperature

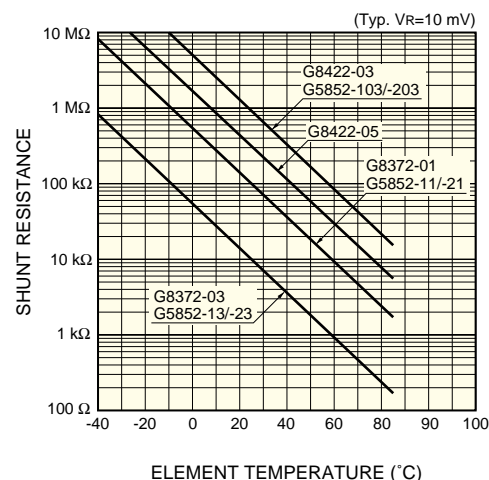

KIRDB0237EA

■ Thermistor temperature characteristic

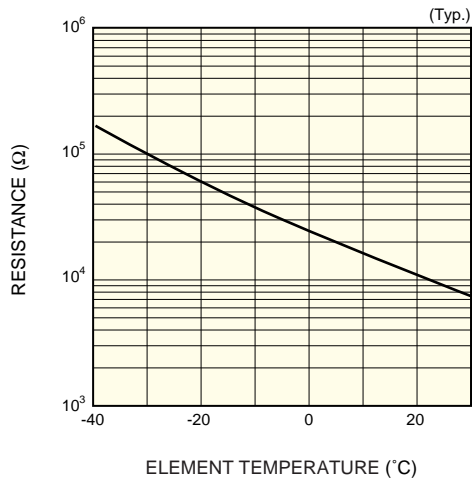

KIRDB0116EA

■ Cooling characteristics of TE-cooler

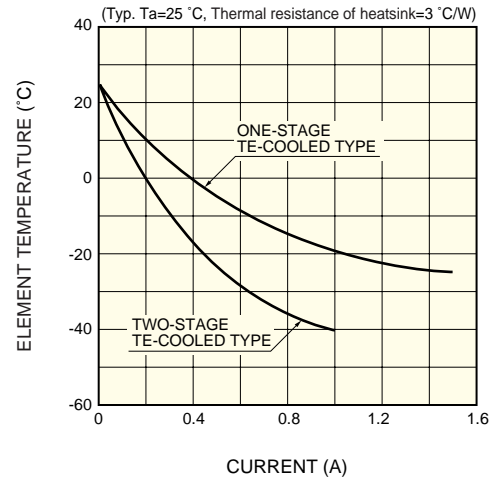

KIRDB0231EA

■ Current vs. voltage characteristics of TE-cooler

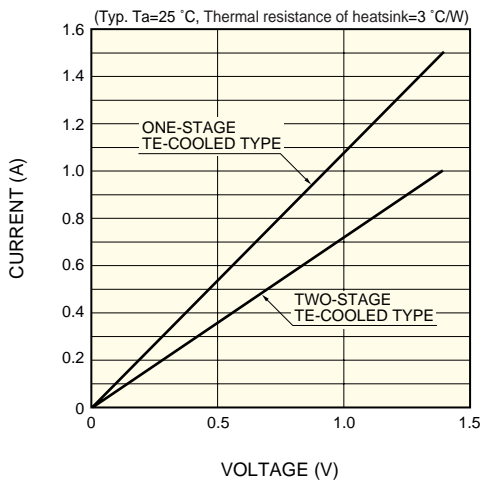

KIRDB0115EA

InGaAs PIN photodiode G8422/G8372/G5852 series

Dimensional outline (unit: mm)

① G8422-03/-05, G8372-01

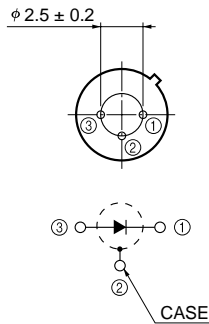
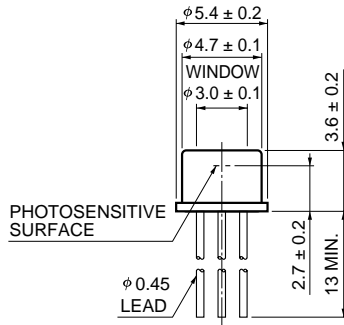

KIRDA0150EA

② G8372-03

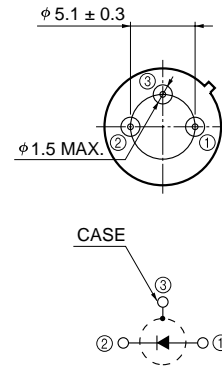
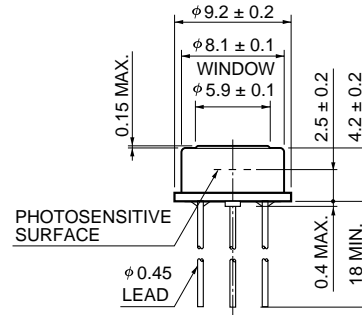

KIRDA0151EA

③ G5852-103/-11/-13

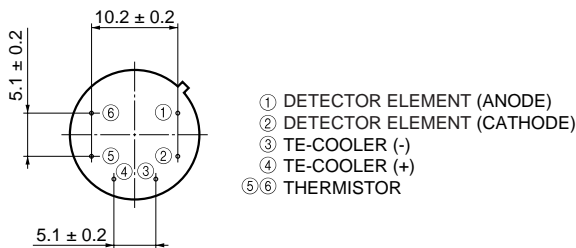
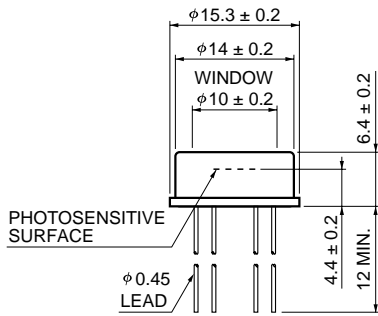

KIRDA0029EB

④ G5852-203/-21/-23

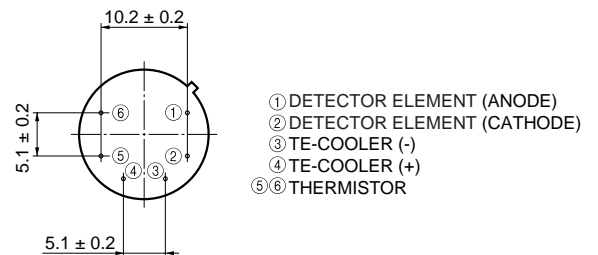
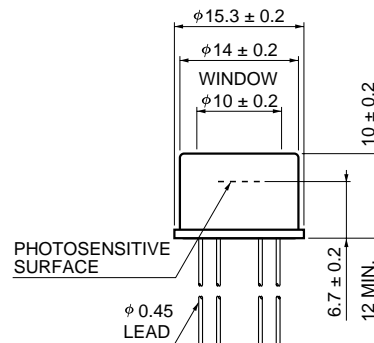

KIRDA0031EB

HAMAMATSU Information furnished by HAMAMATSU is believed to be reliable. However, no responsibility is assumed for possible inaccuracies or omissions.

Specifications are subject to change without notice. No patent rights are granted to any of the circuits described herein. ©2001 Hamamatsu Photonics K.K.

HAMAMATSU PHOTONICS K.K., Solid State Division

1126-1 Ichino-cho, Hamamatsu City, 435-8558 Japan, Telephone: (81) 053-434-3311, Fax: (81) 053-434-5184, <http://www.hamamatsu.com>

U.S.A.: Hamamatsu Corporation: 360 Foothill Road, P.O.Box 6910, Bridgewater, N.J. 08807-0910, U.S.A., Telephone: (1) 908-231-0960, Fax: (1) 908-231-1218

Germany: Hamamatsu Photonics Deutschland GmbH: Arzbergerstr. 10, D-82211 Herrsching am Ammersee, Germany, Telephone: (49) 08152-3750, Fax: (49) 08152-2658

France: Hamamatsu Photonics France S.A.R.L.: 8, Rue du Saule Trapu, Parc du Moulin de Massy, 91882 Massy Cedex, France, Telephone: 33-(1) 69 53 71 00, Fax: 33-(1) 69 53 71 10

United Kingdom: Hamamatsu Photonics UK Limited: 2 Howard Court, 10 Tewin Road, Welwyn Garden City, Hertfordshire AL7 1BW, United Kingdom, Telephone: (44) 1707-294888, Fax: (44) 1707-325777

North Europe: Hamamatsu Photonics Norden AB: Smidesvägen 12, SE-171 41 Solna, Sweden, Telephone: (46) 8-509-031-00, Fax: (46) 8-509-031-01

Italy: Hamamatsu Photonics Italia S.R.L.: Strada della Moia, 1/E, 20020 Arese, (Milano), Italy, Telephone: (39) 02-935-81-733, Fax: (39) 02-935-81-741

Cat. No. KIRD1047E02
Sep. 2001 DN