

Thyristors

BT300B series

GENERAL DESCRIPTION

Glass passivated thyristors in a plastic envelope suitable for surface mounting, intended for use in applications requiring high bidirectional blocking voltage capability and high thermal cycling performance. Typical applications include motor control, industrial and domestic lighting, heating and static switching.

QUICK REFERENCE DATA

SYMBOL	PARAMETER	MAX.	MAX.	MAX.	UNIT
		500R	600R	800R	
V_{DRM}, V_{RRM}	Repetitive peak off-state voltages	500	600	800	V
$I_{T(AV)}$	Average on-state current	5	5	5	A
$I_{T(RMS)}$	RMS on-state current	8	8	8	A
I_{TSM}	Non-repetitive peak on-state current	65	65	65	A

PINNING - SOT404

PIN	DESCRIPTION
1	cathode
2	anode
3	gate
mb	anode

PIN CONFIGURATION

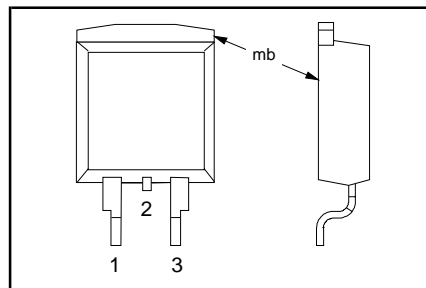

SYMBOL

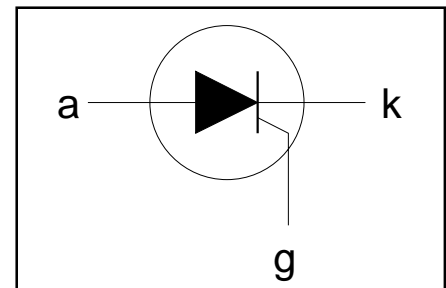

LIMITING VALUES

Limiting values in accordance with the Absolute Maximum System (IEC 134).

SYMBOL	PARAMETER	CONDITIONS	MIN.	MAX.			UNIT
				-500R	-600R	-800R	
V_{DRM}, V_{RRM}	Repetitive peak off-state voltages		-	500 ¹	600 ¹	800	V
$I_{T(AV)}$	Average on-state current	half sine wave; $T_{mb} \leq 111\text{ }^\circ\text{C}$	-	5			A
$I_{T(RMS)}$	RMS on-state current	all conduction angles	-	8			A
I_{TSM}	Non-repetitive peak on-state current	half sine wave; $T_j = 25\text{ }^\circ\text{C}$ prior to surge	-	65			A
I^2t	I^2t for fusing	$t = 10\text{ ms}$	-	71			A
di_T/dt	Repetitive rate of rise of on-state current after triggering	$t = 8.3\text{ ms}$	-	21			A ² s
		$t = 10\text{ ms}$	-	50			A/ μs
I_{GM}	Peak gate current	$I_{TM} = 10\text{ A}; I_G = 50\text{ mA}; di_G/dt = 50\text{ mA}/\mu\text{s}$	-	2			A
V_{GM}	Peak gate voltage		-	5			V
V_{RGM}	Peak reverse gate voltage		-	5			V
P_{GM}	Peak gate power		-	5			W
$P_{G(AV)}$	Average gate power	over any 20 ms period	-	0.5			W
T_{stg}	Storage temperature		-40	150			$^\circ\text{C}$
T_j	Operating junction temperature		-	125			$^\circ\text{C}$

¹ Although not recommended, off-state voltages up to 800V may be applied without damage, but the thyristor may switch to the on-state. The rate of rise of current should not exceed 15 A/ μs .

Thyristors

BT300B series

THERMAL RESISTANCES

SYMBOL	PARAMETER	CONDITIONS	MIN.	TYP.	MAX.	UNIT
$R_{th\ j-mb}$	Thermal resistance junction to mounting base	minimum footprint, FR4 board	-	-	1.8	K/W
$R_{th\ j-a}$	Thermal resistance junction to ambient		-	55	-	K/W

STATIC CHARACTERISTICS $T_j = 25\text{ °C}$ unless otherwise stated

SYMBOL	PARAMETER	CONDITIONS	MIN.	TYP.	MAX.	UNIT
I_{GT}	Gate trigger current	$V_D = 12\text{ V}; I_T = 0.1\text{ A}$	-	2	15	mA
I_L	Latching current	$V_D = 12\text{ V}; I_{GT} = 0.1\text{ A}$	-	10	40	mA
I_H	Holding current	$V_D = 12\text{ V}; I_{GT} = 0.1\text{ A}$	-	10	20	mA
V_T	On-state voltage	$I_T = 12\text{ A}$	-	1.35	1.6	V
V_{GT}	Gate trigger voltage	$V_D = 12\text{ V}; I_T = 0.1\text{ A}$	-	0.6	1.5	V
I_D, I_R	Off-state leakage current	$V_D = V_{DRM(max)}; I_T = 0.1\text{ A}; T_j = 125\text{ °C}$	0.25	0.4	-	V
		$V_D = V_{DRM(max)}; V_R = V_{RRM(max)}; T_j = 125\text{ °C}$	-	0.1	0.5	mA

DYNAMIC CHARACTERISTICS $T_j = 25\text{ °C}$ unless otherwise stated

SYMBOL	PARAMETER	CONDITIONS	MIN.	TYP.	MAX.	UNIT
dV_D/dt	Critical rate of rise of off-state voltage	$V_{DM} = 67\% V_{DRM(max)}; T_j = 125\text{ °C};$ exponential waveform.				
		Gate open circuit	50	100	-	V/ μ s
		$R_{GK} = 100\ \Omega$	200	1000	-	V/ μ s
t_{gt}	Gate controlled turn-on time	$I_{TM} = 10\text{ A}; V_D = V_{DRM(max)}; I_G = 0.1\text{ A};$ $di_G/dt = 5\text{ A}/\mu\text{s}$	-	2	-	μ s
t_q	Circuit commutated turn-off time	$V_D = 67\% V_{DRM(max)}; T_j = 125\text{ °C};$ $I_{TM} = 12\text{ A}; V_R = 25\text{ V}; di_{TM}/dt = 30\text{ A}/\mu\text{s};$ $dV_D/dt = 50\text{ V}/\mu\text{s}; R_{GK} = 100\ \Omega$	-	70	-	μ s

Thyristors

BT300B series

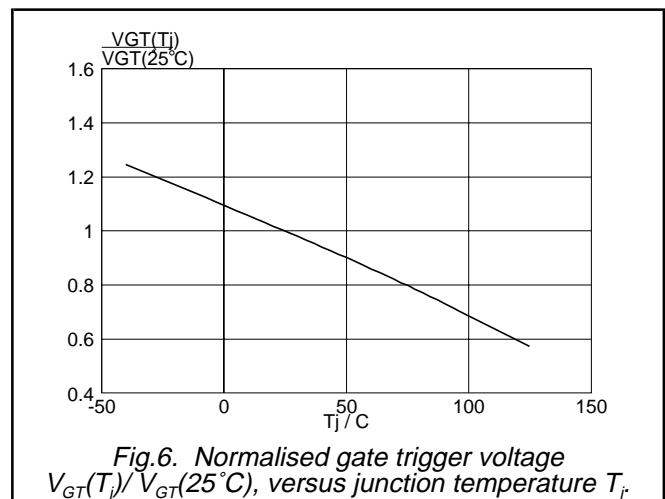
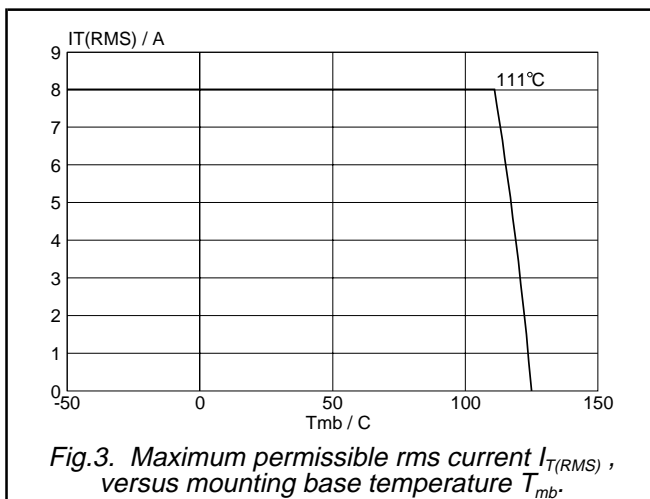
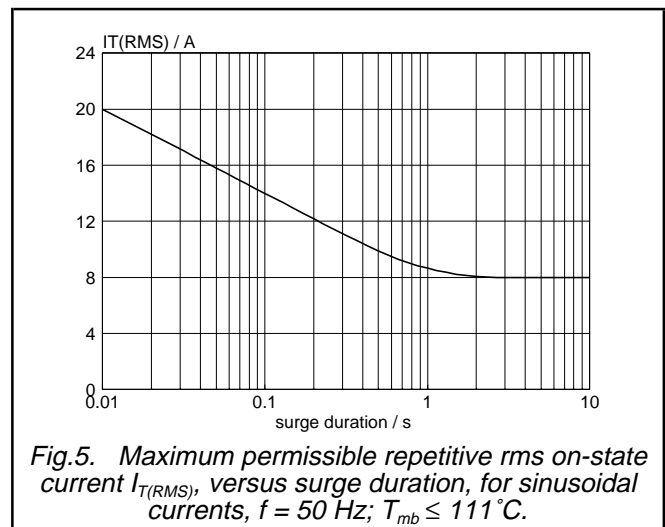
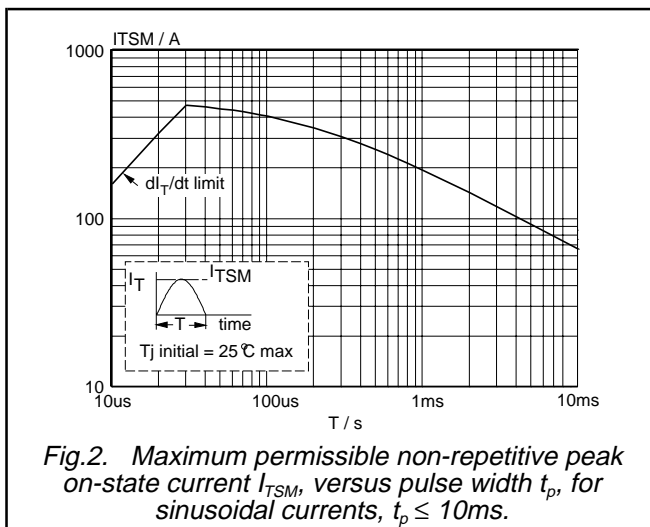
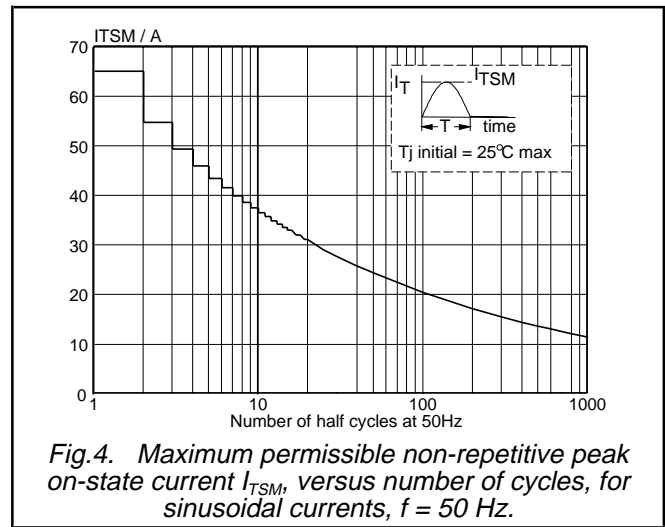
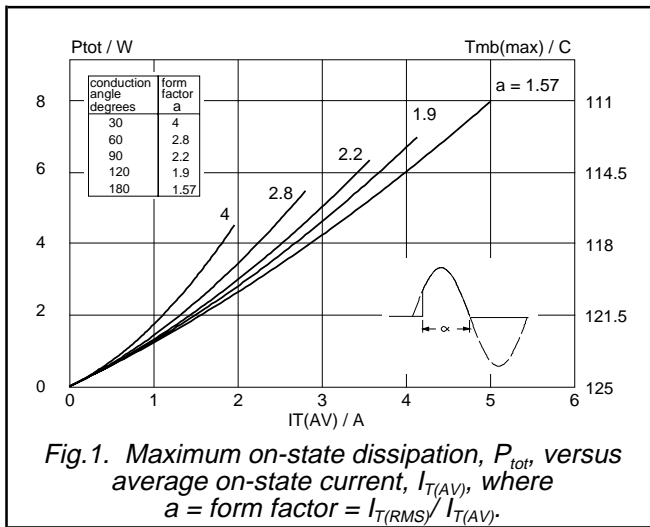

Thyristors

BT300B series

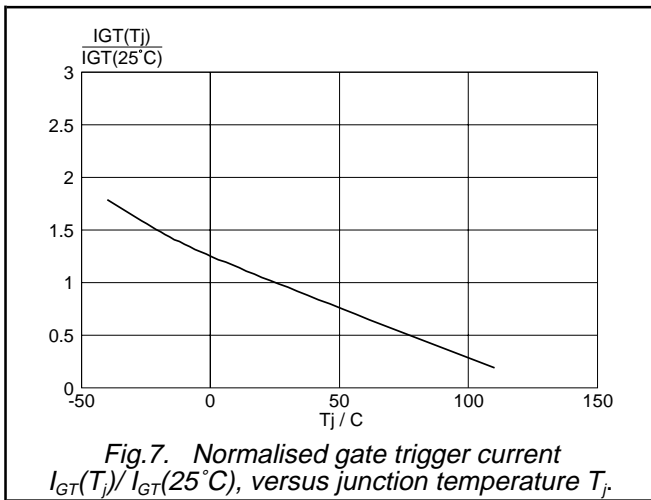

Fig. 7. Normalised gate trigger current $I_{GT}(T_j)/I_{GT}(25^\circ\text{C})$, versus junction temperature T_j .

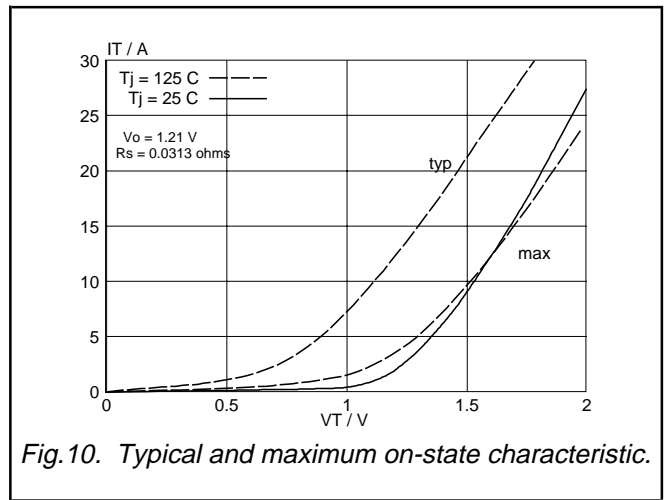

Fig. 10. Typical and maximum on-state characteristic.

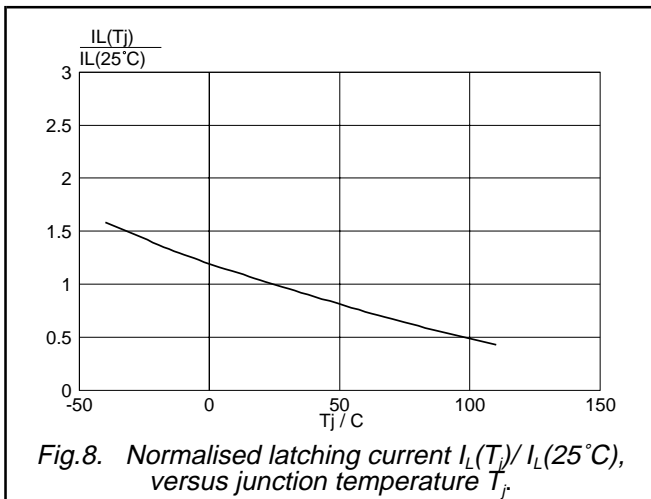

Fig. 8. Normalised latching current $I_L(T_j)/I_L(25^\circ\text{C})$, versus junction temperature T_j .

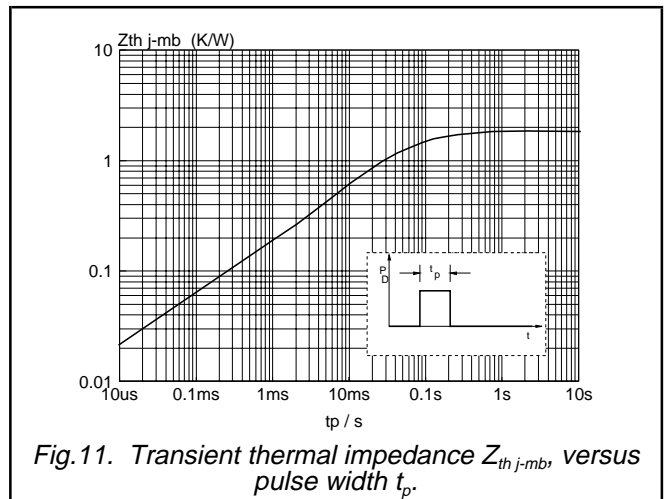

Fig. 11. Transient thermal impedance $Z_{th\ j-mb}$, versus pulse width t_p .

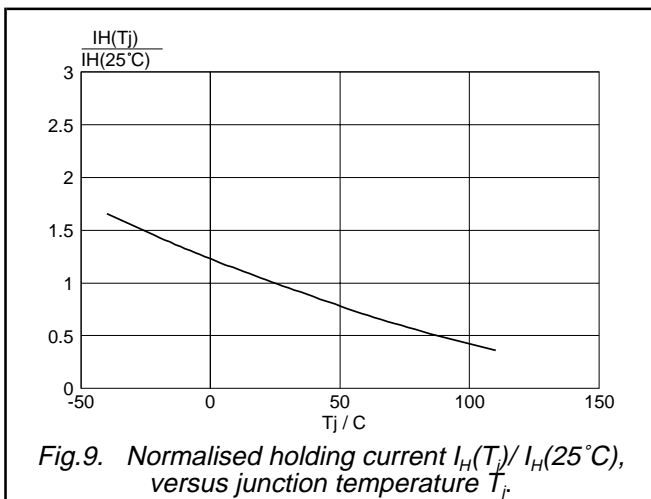

Fig. 9. Normalised holding current $I_H(T_j)/I_H(25^\circ\text{C})$, versus junction temperature T_j .

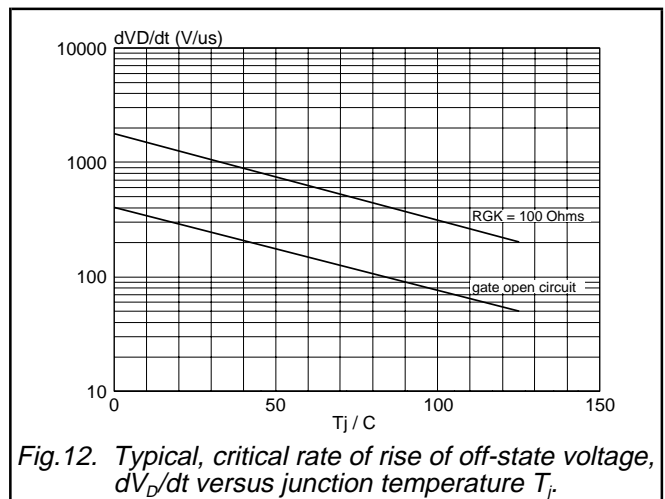

Fig. 12. Typical, critical rate of rise of off-state voltage, dV_D/dt versus junction temperature T_j .

Thyristors

BT300B series

MECHANICAL DATA

Dimensions in mm

Net Mass: 1.4 g

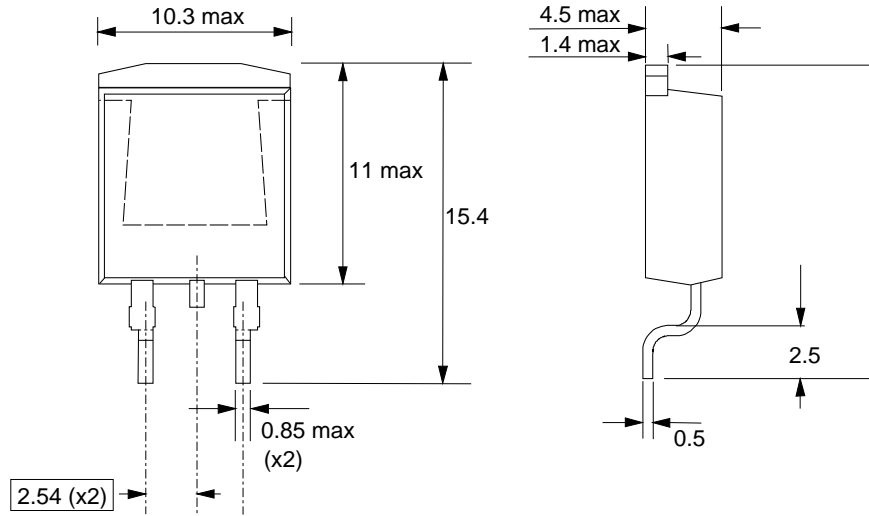

Fig.13. SOT404 : centre pin connected to mounting base.

Notes

- 1. Epoxy meets UL94 V0 at 1/8".

MOUNTING INSTRUCTIONS

Dimensions in mm

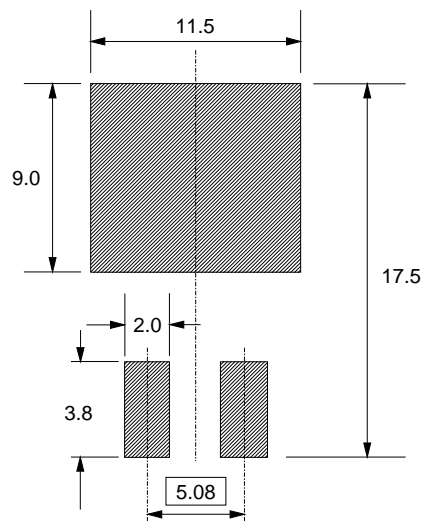

Fig.14. SOT404 : minimum pad sizes for surface mounting.

Notes

- 1. Plastic meets UL94 V0 at 1/8".

Thyristors

BT300B series

DEFINITIONS

Data sheet status	
Objective specification	This data sheet contains target or goal specifications for product development.
Preliminary specification	This data sheet contains preliminary data; supplementary data may be published later.
Product specification	This data sheet contains final product specifications.
Limiting values	
Limiting values are given in accordance with the Absolute Maximum Rating System (IEC 134). Stress above one or more of the limiting values may cause permanent damage to the device. These are stress ratings only and operation of the device at these or at any other conditions above those given in the Characteristics sections of this specification is not implied. Exposure to limiting values for extended periods may affect device reliability.	
Application information	
Where application information is given, it is advisory and does not form part of the specification.	
© Philips Electronics N.V. 1997	
All rights are reserved. Reproduction in whole or in part is prohibited without the prior written consent of the copyright owner.	
The information presented in this document does not form part of any quotation or contract, it is believed to be accurate and reliable and may be changed without notice. No liability will be accepted by the publisher for any consequence of its use. Publication thereof does not convey nor imply any license under patent or other industrial or intellectual property rights.	

LIFE SUPPORT APPLICATIONS

These products are not designed for use in life support appliances, devices or systems where malfunction of these products can be reasonably expected to result in personal injury. Philips customers using or selling these products for use in such applications do so at their own risk and agree to fully indemnify Philips for any damages resulting from such improper use or sale.