

# SM73308

*SM73308 Low Offset, Low Noise, RRO Operational Amplifier*



Literature Number: SNOSB90A

# SM73308

## Low Offset, Low Noise, RRO Operational Amplifier

### General Description

The SM73308 is a Single low noise precision operational amplifier intended for use in a wide range of applications. Other important characteristics include: an extended operating temperature range of  $-40^{\circ}\text{C}$  to  $125^{\circ}\text{C}$ , the tiny SC70-5 package, and low input bias current.

The extended temperature range of  $-40^{\circ}\text{C}$  to  $125^{\circ}\text{C}$  allows the SM73308 to accommodate a broad range of applications. The SM73308 expands National Semiconductor's Silicon Dust™ amplifier portfolio offering enhancements in size, speed, and power savings. The SM73308 is guaranteed to operate over the voltage range of 2.7V to 5.0V and has rail-to-rail output.

The SM73308 is designed for precision, low noise, low voltage, and miniature systems. This amplifier provides rail-to-rail output swing into heavy loads. The maximum input offset is  $850\ \mu\text{V}$  at room temperature and the input common mode voltage range includes ground.

The SM73308 is offered in the tiny SC70-5 package.

### Features

(Unless otherwise noted, typical values at  $V_S = 2.7\text{V}$ )

- Renewable Energy Grade
- Guaranteed 2.7V and 5V specifications
- Maximum  $V_{OS}$  850 $\mu\text{V}$  (limit)
- Voltage noise
  - $f = 100\ \text{Hz}$  12.5nV/ $\sqrt{\text{Hz}}$
  - $f = 10\ \text{kHz}$  7.5nV/ $\sqrt{\text{Hz}}$
- Rail-to-Rail output swing
  - $R_L = 600\ \Omega$  100mV from rail
  - $R_L = 2\ \text{k}\Omega$  50mV from rail
- Open loop gain with  $R_L = 2\ \text{k}\Omega$  100dB
- $V_{CM}$  0 to  $V^+$   $-0.9\text{V}$
- Supply current 550 $\mu\text{A}$
- Gain bandwidth product 3.5MHz
- Temperature range  $-40^{\circ}\text{C}$  to  $125^{\circ}\text{C}$

### Applications

- Transducer amplifier
- Instrumentation amplifier
- Precision current sensing
- Data acquisition systems
- Active filters and buffers
- Sample and hold
- Portable/battery powered electronics
- Automotive



### Connection Diagram

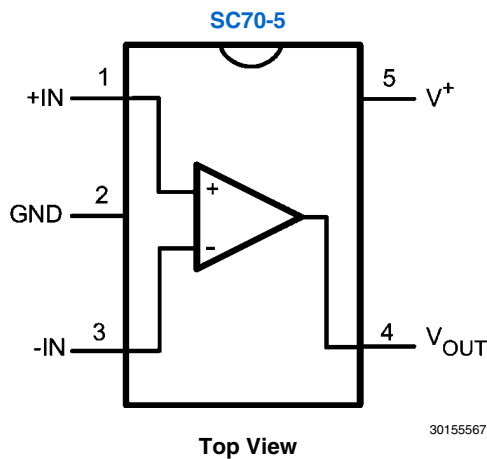

30155567

### Instrumentation Amplifier

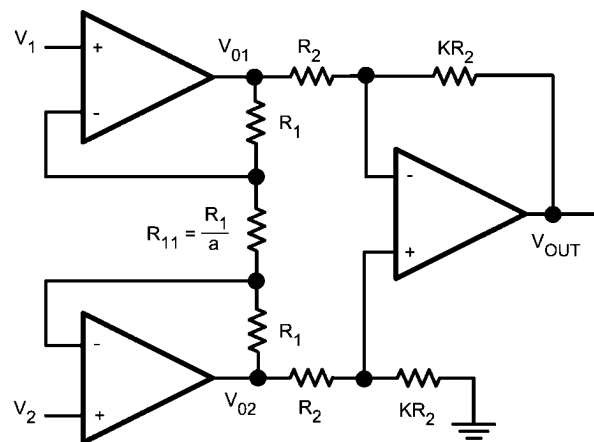

30155536

$$V_O = -K(2a + 1)(V_1 - V_2)$$

Silicon Dust™ is a trademark of National Semiconductor Corporation.

## Absolute Maximum Ratings *(Note 1)*

If Military/Aerospace specified devices are required, please contact the National Semiconductor Sales Office/Distributors for availability and specifications.

### ESD Tolerance *(Note 2)*

Machine Model	200V
Human Body Model	2000V
Differential Input Voltage	$\pm$ Supply Voltage
Voltage at Input Pins	$(V^+) + 0.3V, (V^-) - 0.3V$
Current at Input Pins	$\pm 10$ mA
Supply Voltage ( $V^+ - V^-$ )	5.75V
Output Short Circuit to $V^+$	<i>(Note 3)</i>
Output Short Circuit to $V^-$	<i>(Note 4)</i>

### Mounting Temperature

Infrared or Convection (20 sec)	235°C
Wave Soldering Lead Temp (10 sec)	260°C
Storage Temperature Range	-65°C to 150°C
Junction Temperature <i>(Note 5)</i>	150°C

## Operating Ratings *(Note 1)*

Supply Voltage	2.7V to 5.5V
Temperature Range	-40°C to 125°C
Thermal Resistance ( $\theta_{JA}$ )	440 °C/W

## 2.7V DC Electrical Characteristics *(Note 11)*

Unless otherwise specified, all limits are guaranteed for  $T_A = 25^\circ\text{C}$ .  $V^+ = 2.7V$ ,  $V^- = 0V$ ,  $V_{CM} = V^+/2$ ,  $V_O = V^+/2$  and  $R_L > 1M\Omega$ . **Boldface** limits apply at the temperature extremes.

Symbol	Parameter	Condition	Min <i>(Note 7)</i>	Typ <i>(Note 6)</i>	Max <i>(Note 7)</i>	Units
$V_{OS}$	Input Offset Voltage			0.3	0.85 <b>1.0</b>	mV
$TCV_{OS}$	Input Offset Voltage Average Drift			-0.45		$\mu\text{V}/^\circ\text{C}$
$I_B$	Input Bias Current <i>(Note 8)</i>	$V_{CM} = 1V$		-0.1	100 <b>250</b>	pA
$I_{OS}$	Input Offset Current <i>(Note 8)</i>			0.004	100	pA
$I_S$	Supply Current			550	900 <b>910</b>	$\mu\text{A}$
CMRR	Common Mode Rejection Ratio	$0.5 \leq V_{CM} \leq 1.2V$	74 <b>72</b>	80		dB
PSSR	Power Supply Rejection Ratio	$2.7V \leq V^+ \leq 5V$	82 <b>76</b>	90		dB
$V_{CM}$	Input Common-Mode Voltage Range	For CMRR $\geq 50\text{dB}$	0		1.8	V
$A_V$	Large Signal Voltage Gain <i>(Note 9)</i>	$R_L = 600\Omega$ to 1.35V, $V_O = 0.2V$ to 2.5V	92 <b>80</b>	100		dB
		$R_L = 2k\Omega$ to 1.35V, $V_O = 0.2V$ to 2.5V	98 <b>86</b>	100		
$V_O$	Output Swing	$R_L = 600\Omega$ to 1.35V $V_{IN} = \pm 100\text{mV}$	0.11 <b>0.14</b>	0.084 to 2.62	2.59 <b>2.56</b>	V
		$R_L = 2k\Omega$ to 1.35V $V_{IN} = \pm 100\text{mV}$	0.05 <b>0.06</b>	0.026 to 2.68	2.65 <b>2.64</b>	
$I_O$	Output Short Circuit Current	Sourcing, $V_O = 0V$ $V_{IN} = 100\text{mV}$	18 <b>11</b>	24		mA
		Sinking, $V_O = 2.7V$ $V_{IN} = -100\text{mV}$	18 <b>11</b>	22		

## 2.7V AC Electrical Characteristics *(Note 11)*

Unless otherwise specified, all limits are guaranteed for  $T_A = 25^\circ\text{C}$ .  $V^+ = 5.0\text{V}$ ,  $V^- = 0\text{V}$ ,  $V_{\text{CM}} = V^+/2$ ,  $V_O = V^+/2$  and  $R_L > 1\text{M}\Omega$ . **Boldface** limits apply at the temperature extremes.

Symbol	Parameter	Conditions	Min <i>(Note 7)</i>	Typ <i>(Note 6)</i>	Max <i>(Note 7)</i>	Units
SR	Slew Rate <i>(Note 10)</i>	$A_V = +1$ , $R_L = 10\text{ k}\Omega$		1.4		V/ $\mu\text{s}$
GBW	Gain-Bandwidth Product			3.5		MHz
$\Phi_m$	Phase Margin			79		Deg
$G_m$	Gain Margin			-15		dB
$e_n$	Input-Referred Voltage Noise (Flatband)	$f = 10\text{kHz}$		7.5		$\text{nV}/\sqrt{\text{Hz}}$
$e_n$	Input-Referred Voltage Noise (1/f)	$f = 100\text{Hz}$		12.5		$\text{nV}/\sqrt{\text{Hz}}$
$i_n$	Input-Referred Current Noise	$f = 1\text{kHz}$		0.001		$\text{pA}/\sqrt{\text{Hz}}$
THD	Total Harmonic Distortion	$f = 1\text{kHz}$ , $A_V = +1$ $R_L = 600\Omega$ , $V_{\text{IN}} = 1\text{ V}_{\text{PP}}$		0.007		%

## 5.0V DC Electrical Characteristics *(Note 11)*

Unless otherwise specified, all limits are guaranteed for  $T_A = 25^\circ\text{C}$ .  $V^+ = 5.0\text{V}$ ,  $V^- = 0\text{V}$ ,  $V_{\text{CM}} = V^+/2$ ,  $V_O = V^+/2$  and  $R_L > 1\text{M}\Omega$ . **Boldface** limits apply at the temperature extremes.

Symbol	Parameter	Condition	Min <i>(Note 7)</i>	Typ <i>(Note 6)</i>	Max <i>(Note 7)</i>	Units
$V_{\text{OS}}$	Input Offset Voltage			0.25	0.85 <b>1.0</b>	mV
$\text{TCV}_{\text{OS}}$	Input Offset Voltage Average Drift			-0.35		$\mu\text{V}/^\circ\text{C}$
$I_B$	Input Bias Current <i>(Note 8)</i>	$V_{\text{CM}} = 1\text{V}$		-0.23	100 <b>250</b>	pA
$I_{\text{OS}}$	Input Offset Current <i>(Note 8)</i>			0.017	100	pA
$I_S$	Supply Current			600	950 <b>960</b>	$\mu\text{A}$
CMRR	Common Mode Rejection Ratio	$0.5 \leq V_{\text{CM}} \leq 3.5\text{V}$	80 <b>79</b>	90		dB
PSRR	Power Supply Rejection Ratio	$2.7\text{V} \leq V^+ \leq 5\text{V}$	82 <b>76</b>	90		dB
$V_{\text{CM}}$	Input Common-Mode Voltage Range	For CMRR $\geq 50\text{dB}$	0		4.1	V
$A_V$	Large Signal Voltage Gain <i>(Note 9)</i>	$R_L = 600\Omega$ to $2.5\text{V}$ , $V_O = 0.2\text{V}$ to $4.8\text{V}$	92 <b>89</b>	100		dB
		$R_L = 2\text{k}\Omega$ to $2.5\text{V}$ , $V_O = 0.2\text{V}$ to $4.8\text{V}$	98 <b>95</b>	100		
$V_O$	Output Swing	$R_L = 600\Omega$ to $2.5\text{V}$ $V_{\text{IN}} = \pm 100\text{mV}$	0.15 <b>0.23</b>	0.112 to 4.9	4.85 <b>4.77</b>	V
		$R_L = 2\text{k}\Omega$ to $2.5\text{V}$ $V_{\text{IN}} = \pm 100\text{mV}$	0.06 <b>0.07</b>	0.035 to 4.97	4.94 <b>4.93</b>	
$I_O$	Output Short Circuit Current <i>(Note 8, Note 12)</i>	Sourcing, $V_O = 0\text{V}$ $V_{\text{IN}} = 100\text{mV}$	35 <b>35</b>	75		mA
		Sinking, $V_O = 2.7\text{V}$ $V_{\text{IN}} = -100\text{mV}$	35 <b>35</b>	66		

## 5.0V AC Electrical Characteristics *(Note 11)*

Unless otherwise specified, all limits are guaranteed for  $T_A = 25^\circ\text{C}$ .  $V^+ = 5.0\text{V}$ ,  $V^- = 0\text{V}$ ,  $V_{\text{CM}} = V^+/2$ ,  $V_O = V^+/2$  and  $R_L > 1\text{M}\Omega$ .

**Boldface** limits apply at the temperature extremes.

Symbol	Parameter	Conditions	Min <i>(Note 7)</i>	Typ <i>(Note 6)</i>	Max <i>(Note 7)</i>	Units
SR	Slew Rate <i>(Note 10)</i>	$A_V = +1$ , $R_L = 10\text{ k}\Omega$		1.4		V/ $\mu\text{s}$
GBW	Gain-Bandwidth Product			3.5		MHz
$\Phi_m$	Phase Margin			79		Deg
$G_m$	Gain Margin			-15		dB
$e_n$	Input-Referred Voltage Noise (Flatband)	$f = 10\text{kHz}$		6.5		nV/ $\sqrt{\text{Hz}}$
$e_n$	Input-Referred Voltage Noise (1/f)	$f = 100\text{Hz}$		12		nV/ $\sqrt{\text{Hz}}$
$i_n$	Input-Referred Current Noise	$f = 1\text{kHz}$		0.001		pA/ $\sqrt{\text{Hz}}$
THD	Total Harmonic Distortion	$f = 1\text{kHz}$ , $A_V = +1$ $R_L = 600\Omega$ , $V_{\text{IN}} = 1\text{ V}_{\text{PP}}$		0.007		%

**Note 1:** Absolute Maximum Ratings indicate limits beyond which damage to the device may occur. Operating Ratings indicate conditions for which the device is intended to be functional, but specific performance is not guaranteed. For guaranteed specifications and the test conditions, see the Electrical Characteristics.

**Note 2:** Human Body Model is 1.5 k $\Omega$  in series with 100 pF. Machine Model is 0 $\Omega$  in series with 20 pF.

**Note 3:** Shorting output to  $V^+$  will adversely affect reliability.

**Note 4:** Shorting output to  $V^-$  will adversely affect reliability.

**Note 5:** The maximum power dissipation is a function of  $T_{\text{J(MAX)}}$ ,  $\theta_{\text{JA}}$ , and  $T_A$ . The maximum allowable power dissipation at any ambient temperature is  $P_D = (T_{\text{J(MAX)}} - T_A) / \theta_{\text{JA}}$ . All numbers apply for packages soldered directly into a PC board.

**Note 6:** Typical values represent the most likely parametric norm.

**Note 7:** All limits are guaranteed by testing or statistical analysis.

**Note 8:** Limits guaranteed by design.

**Note 9:**  $R_L$  is connected to mid-supply. The output voltage is set at 200mV from the rails.  $V_O = \text{GND} + 0.2\text{V}$  and  $V_O = V^+ - 0.2\text{V}$

**Note 10:** The number specified is the slower of positive and negative slew rates.

**Note 11:** Electrical Table values apply only for factory testing conditions at the temperature indicated. Factory testing conditions result in very limited self-heating of the device such that  $T_J = T_A$ .

**Note 12:** Continuous operation of the device with an output short circuit current larger than 35mA may cause permanent damage to the device.

## Connection Diagram

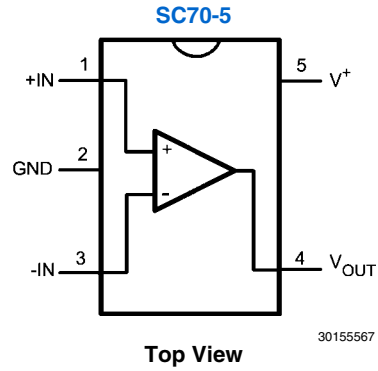

## Ordering Information

Package	Part Number	Package Marking	Transport Media	NSC Drawing
SC70-5	SM73308MG	S08	1k Units Tape and Reel	MAA05A
	SM73308MGX		3k Units Tape and Reel	
	SM73308MGE		250 Units Tape and Reel	

# Typical Performance Characteristics

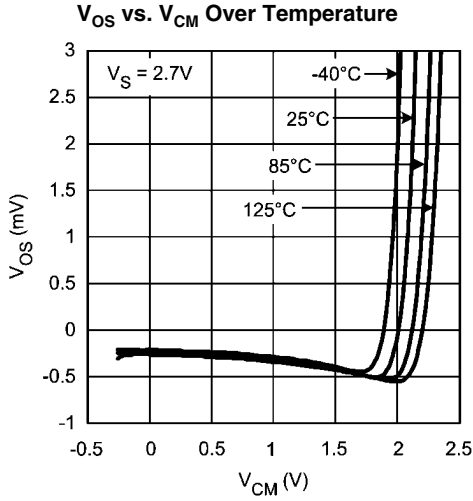

30155527

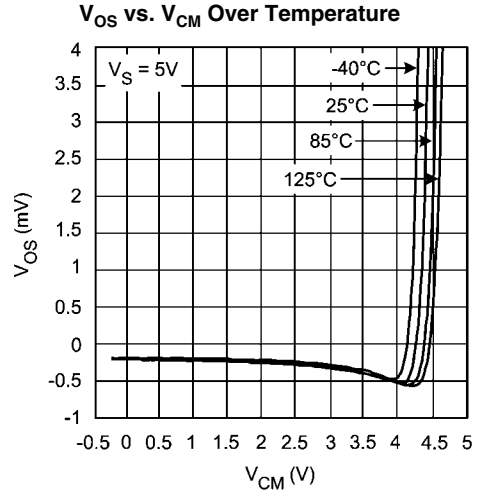

30155526

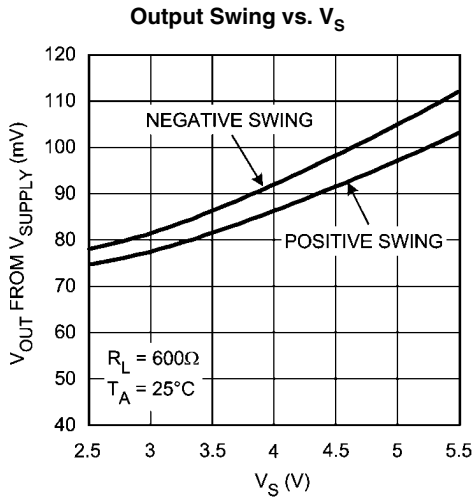

30155525

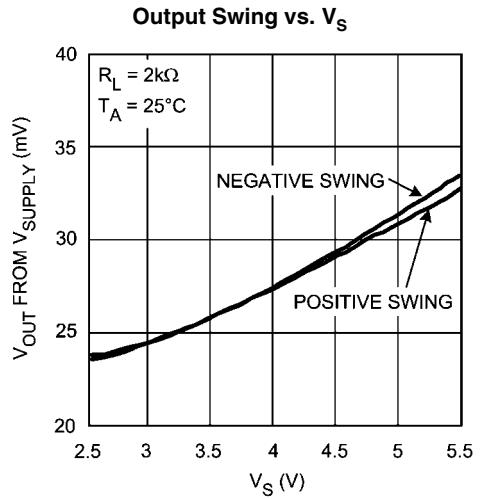

30155524

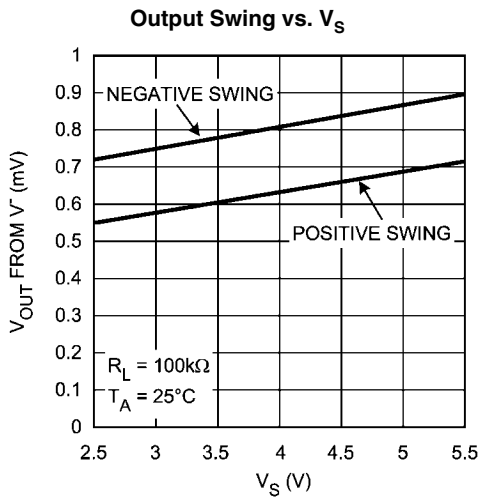

30155523

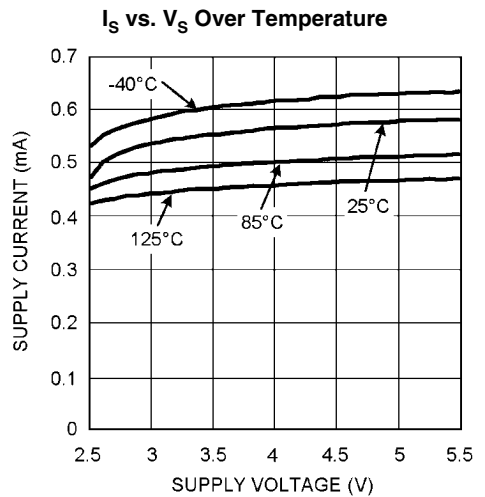

30155530

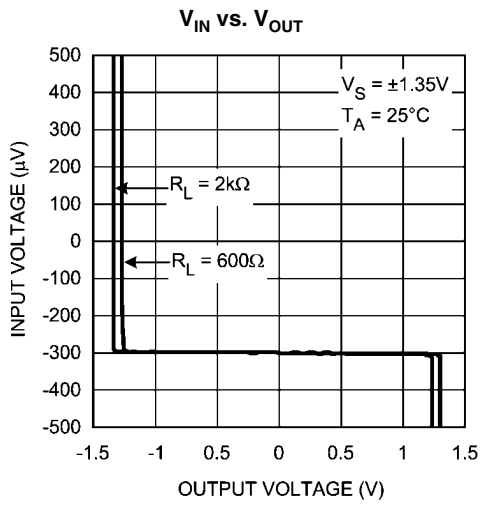

30155528

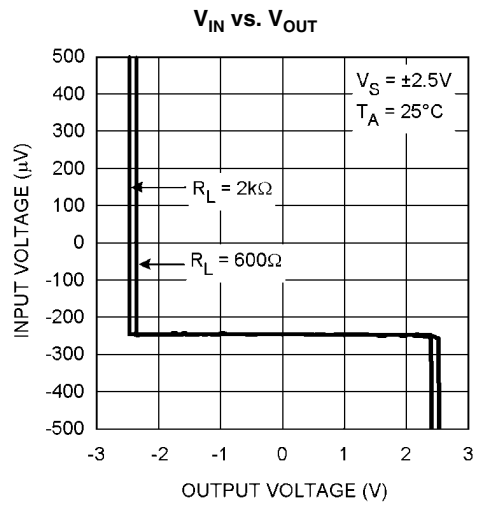

30155529

Sourcing Current vs. V<sub>OUT</sub> (Note 12)

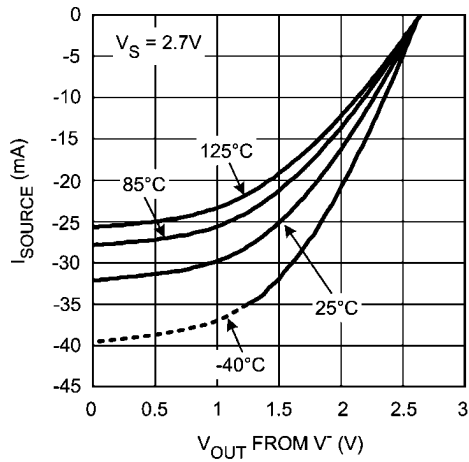

30155531

Sourcing Current vs. V<sub>OUT</sub> (Note 12)

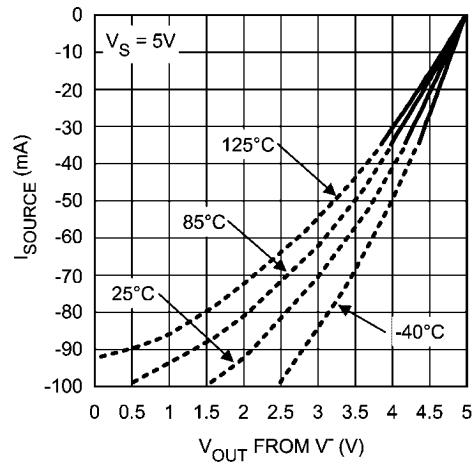

30155564

Sinking Current vs. V<sub>OUT</sub> (Note 12)

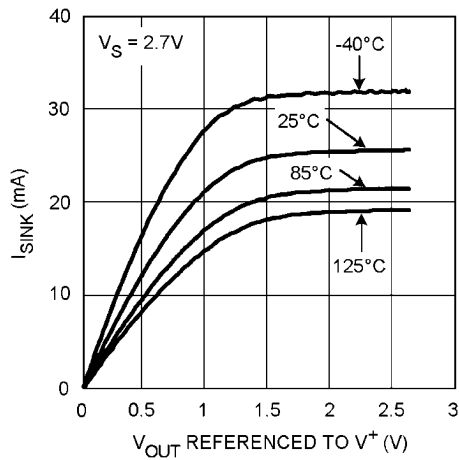

30155532

Sinking Current vs. V<sub>OUT</sub> (Note 12)

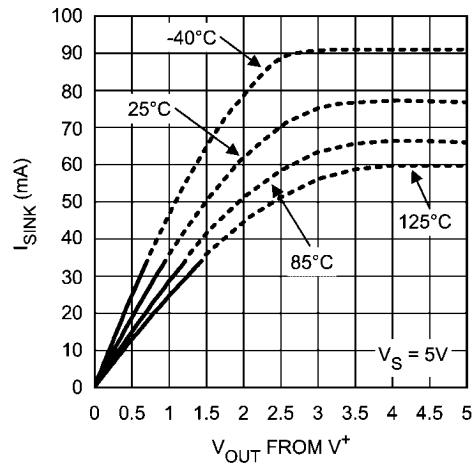

30155563

Input Voltage Noise vs. Frequency

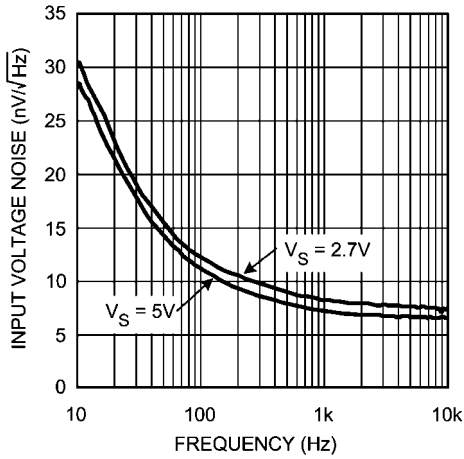

30155508

Input Bias Current Over Temperature

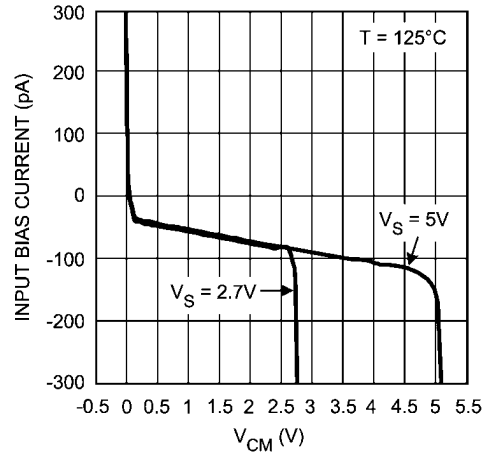

30155535

Input Bias Current Over Temperature

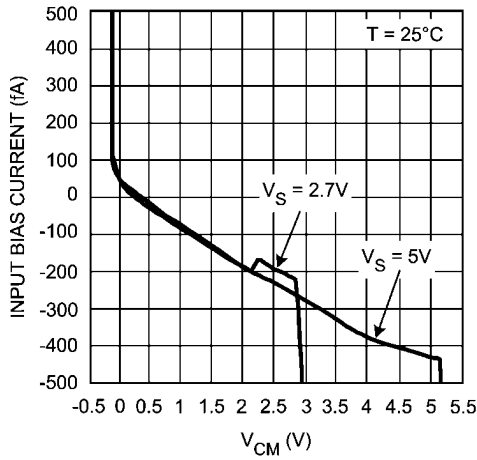

30155534

Input Bias Current Over Temperature

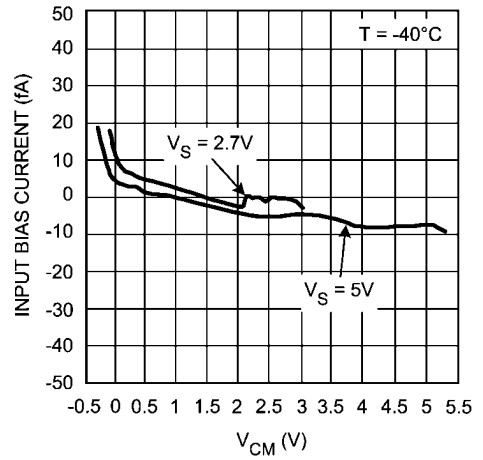

30155533

THD+N vs. Frequency

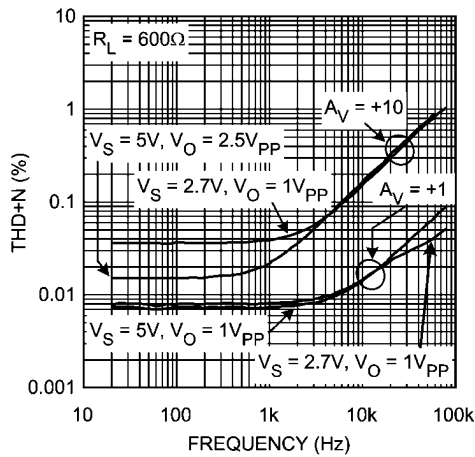

30155507

THD+N vs. VOUT

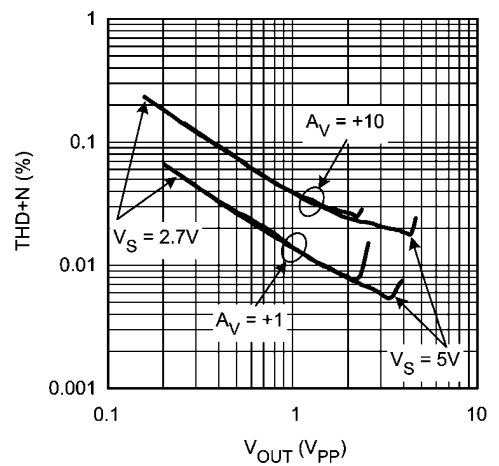

30155566

Slew Rate vs. Supply Voltage

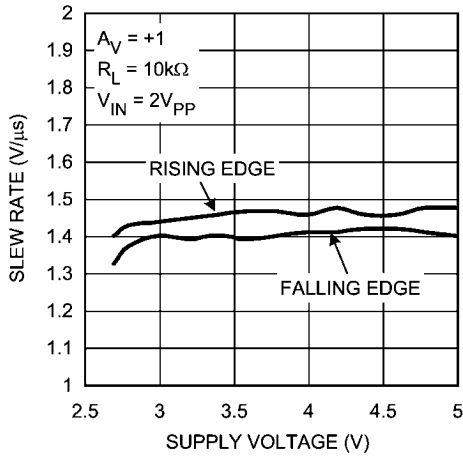

30155501

Open Loop Frequency Response Over Temperature

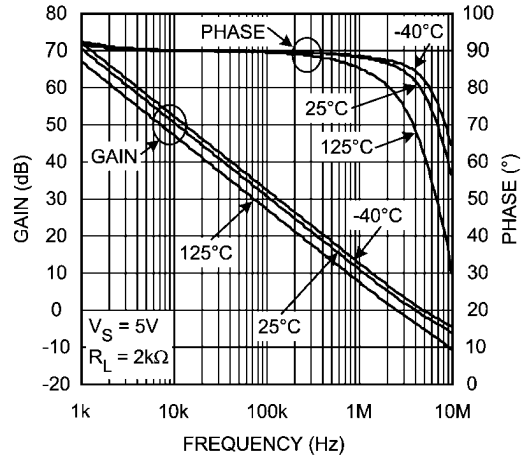

30155502

Open Loop Frequency Response

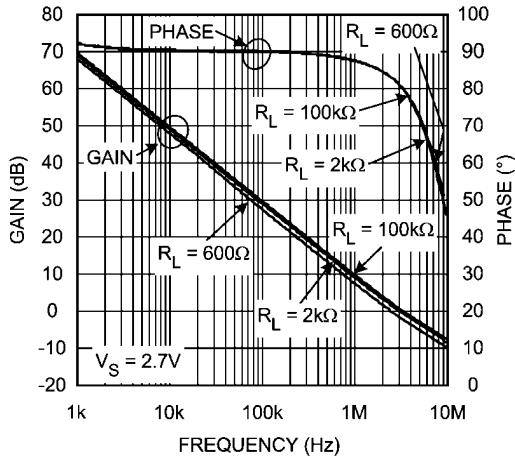

30155503

Open Loop Frequency Response

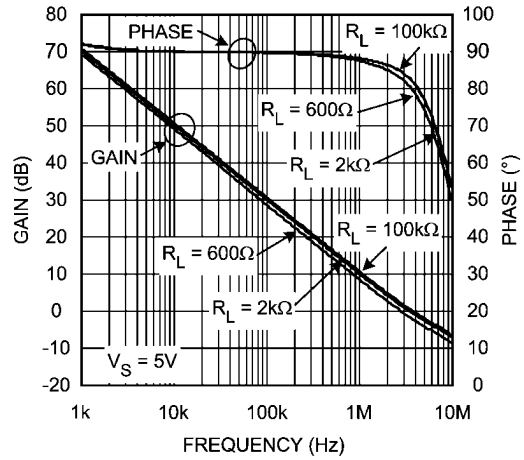

30155504

Open Loop Gain & Phase with Cap. Loading

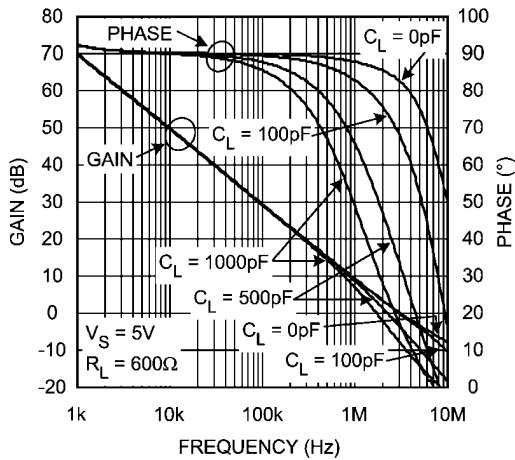

30155505

Open Loop Gain & Phase with Cap. Loading

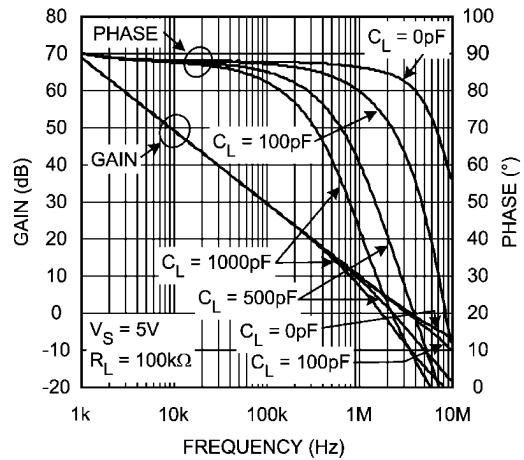

30155506

**Non-Inverting Small Signal Pulse Response**

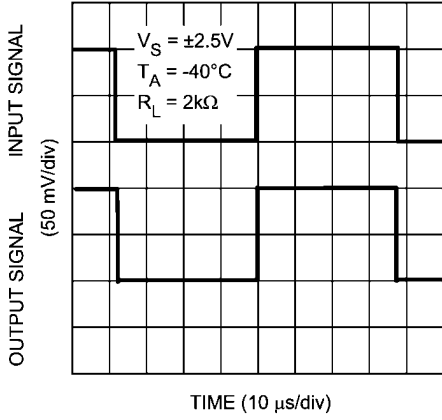

30155517

**Non-Inverting Large Signal Pulse Response**

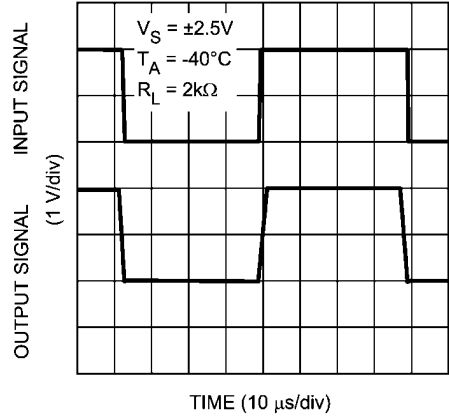

30155511

**Non-Inverting Small Signal Pulse Response**

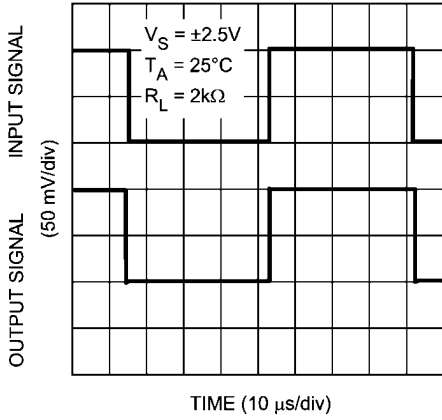

30155516

**Non-Inverting Large Signal Pulse Response**

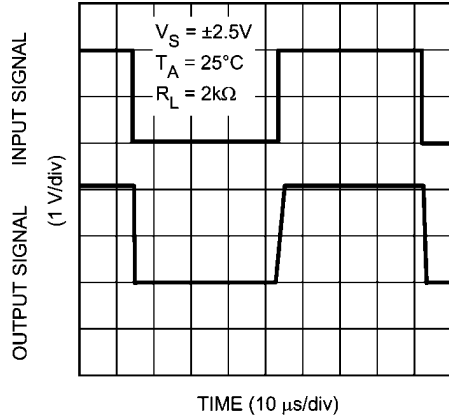

30155510

**Non-Inverting Small Signal Pulse Response**

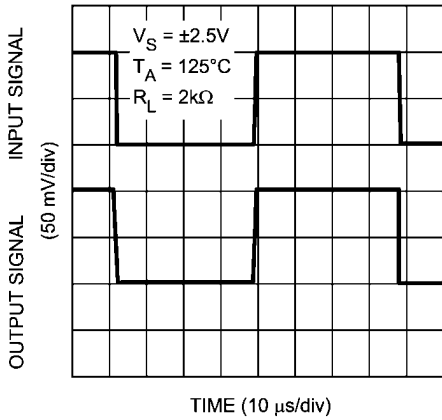

30155515

**Non-Inverting Large Signal Pulse Response**

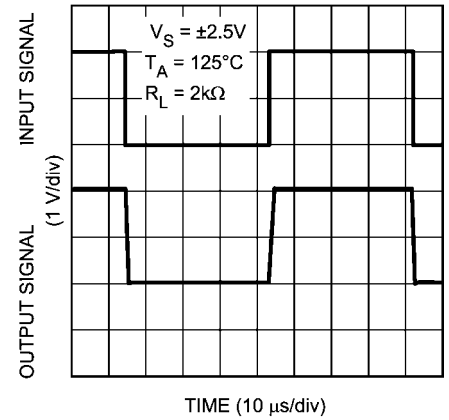

30155509

**Inverting Small Signal Pulse Response**

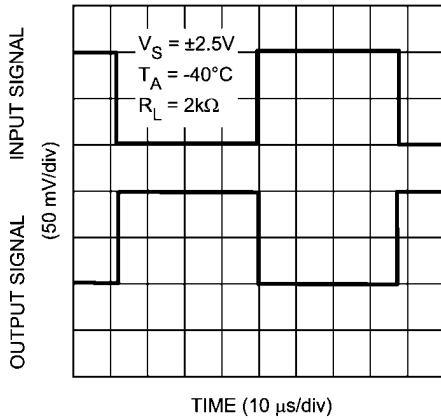

30155519

**Inverting Large Signal Pulse Response**

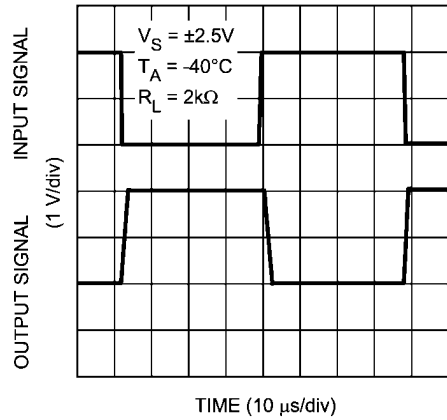

30155514

**Inverting Small Signal Pulse Response**

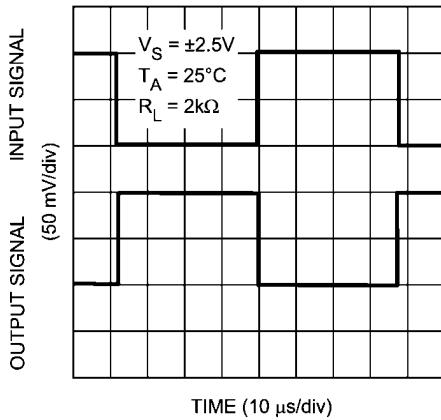

30155520

**Inverting Large Signal Pulse Response**

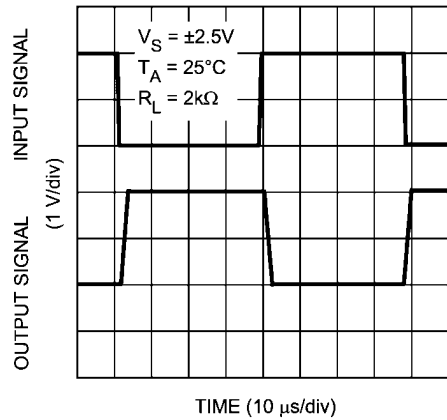

30155513

**Inverting Small Signal Pulse Response**

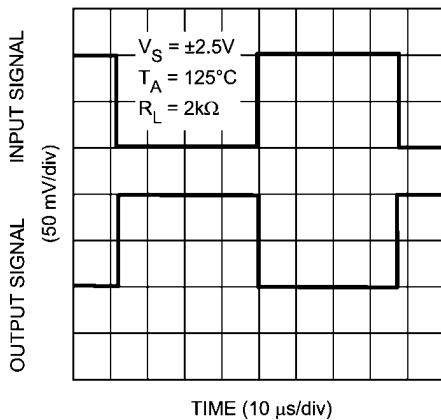

30155518

**Inverting Large Signal Pulse Response**

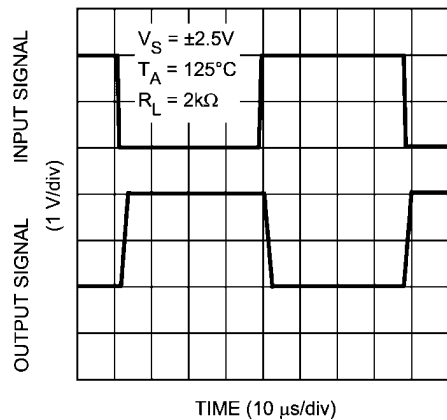

30155512

Stability vs.  $V_{CM}$

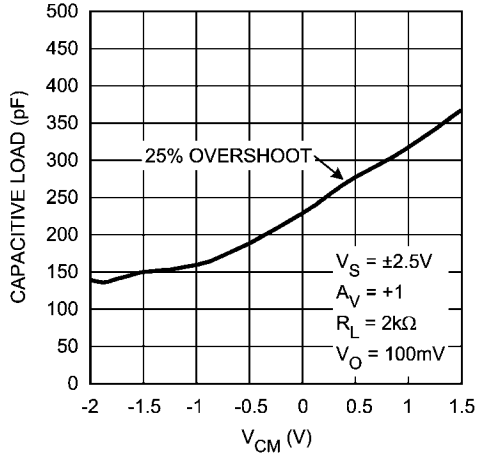

Stability vs.  $V_{CM}$

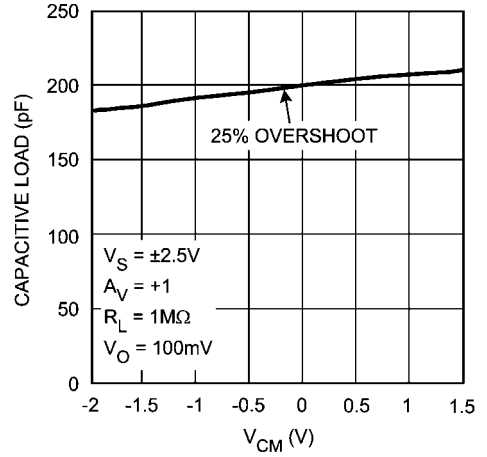

PSRR vs. Frequency

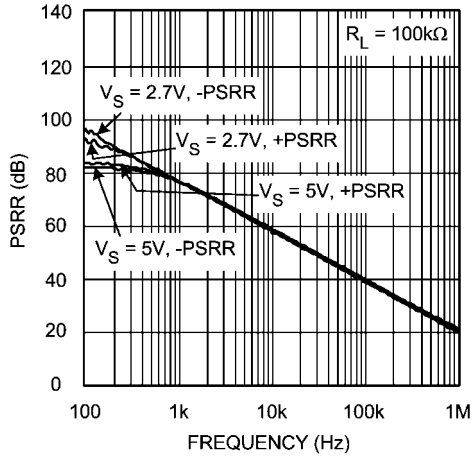

CMRR vs. Frequency

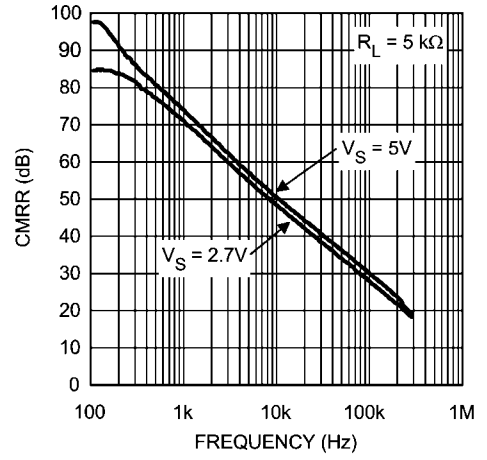

# Application Note

## SM73308

The SM73308 is a precision amplifier with very low noise and ultra low offset voltage. SM73308's extended temperature range of -40°C to 125°C enables the user to design a variety of applications including automotive.

The SM73308 has a maximum offset voltage of 1mV over the extended temperature range. This makes the SM73308 ideal for applications where precision is important.

### INSTRUMENTATION AMPLIFIER

Measurement of very small signals with an amplifier requires close attention to the input impedance of the amplifier, gain of the overall signal on the inputs, and the gain on each input since we are only interested in the difference of the two inputs and the common signal is considered noise. A classic solution is an instrumentation amplifier. Instrumentation amplifiers have a finite, accurate, and stable gain. Also they have extremely high input impedances and very low output impedances. Finally they have an extremely high CMRR so that the amplifier can only respond to the differential signal. A typical instrumentation amplifier is shown in *Figure 1*.

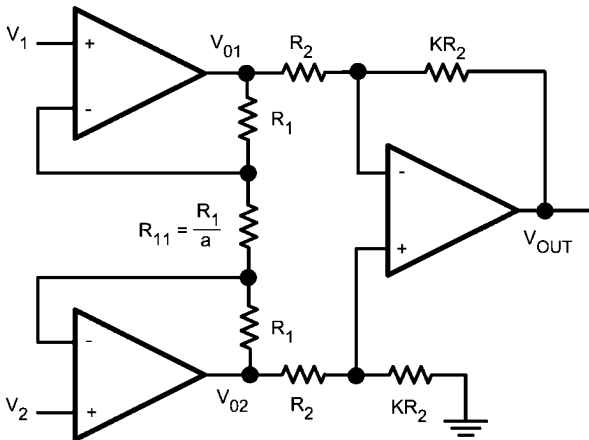

30155536

FIGURE 1. Instrumentation Amplifier

There are two stages in this amplifier. The last stage, output stage, is a differential amplifier. In an ideal case the two amplifiers of the first stage, input stage, would be set up as buffers to isolate the inputs. However they cannot be connected as followers because of real amplifier's mismatch. That is why there is a balancing resistor between the two. The product of the two stages of gain will give the gain of the instrumentation amplifier. Ideally, the CMRR should be infinite. However the output stage has a small non-zero common mode gain which results from resistor mismatch.

In the input stage of the circuit, current is the same across all resistors. This is due to the high input impedance and low input bias current of the SM73308. With the node equations we have:

$$\text{GIVEN: } I_{R_1} = I_{R_{11}} \quad (1)$$

By Ohm's Law:

$$\begin{aligned} V_{O1} - V_{O2} &= (2R_1 + R_{11}) I_{R_{11}} \\ &= (2a + 1) R_{11} \cdot I_{R_{11}} \\ &= (2a + 1) V_{R_{11}} \end{aligned} \quad (2)$$

However:

$$V_{R_{11}} = V_1 - V_2 \quad (3)$$

So we have:

$$V_{O1} - V_{O2} = (2a + 1) (V_1 - V_2) \quad (4)$$

Now looking at the output of the instrumentation amplifier:

$$\begin{aligned} V_O &= \frac{KR_2}{R_2} (V_{O2} - V_{O1}) \\ &= -K (V_{O1} - V_{O2}) \end{aligned} \quad (5)$$

Substituting from *Equation 4*:

$$V_O = -K (2a + 1) (V_1 - V_2) \quad (6)$$

This shows the gain of the instrumentation amplifier to be:

$$-K(2a+1)$$

Typical values for this circuit can be obtained by setting: a = 12 and K = 4. This results in an overall gain of -100.

*Figure 2* shows typical CMRR characteristics of this Instrumentation amplifier over frequency. Three SM73308 amplifiers are used along with 1% resistors to minimize resistor mismatch. Resistors used to build the circuit are: R1 = 21.6kΩ, R11 = 1.8kΩ, R2 = 2.5kΩ with K = 40 and a = 12. This results in an overall gain of -1000, -K(2a+1) = -1000.

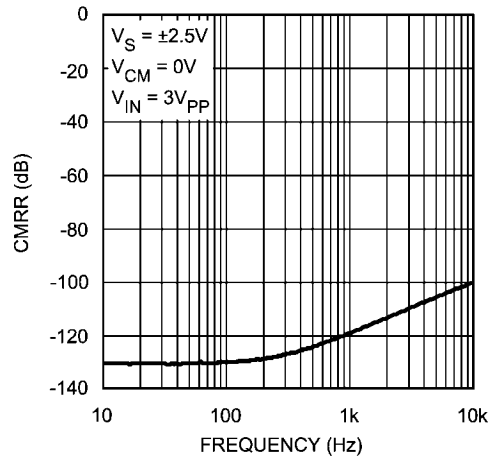

30155573

FIGURE 2. CMRR vs. Frequency

## ACTIVE FILTER

Active filters are circuits with amplifiers, resistors, and capacitors. The use of amplifiers instead of inductors, which are used in passive filters, enhances the circuit performance while reducing the size and complexity of the filter.

The simplest active filters are designed using an inverting op amp configuration where at least one reactive element has been added to the configuration. This means that the op amp will provide "frequency-dependent" amplification, since reactive elements are frequency dependent devices.

## LOW PASS FILTER

The following shows a very simple low pass filter.

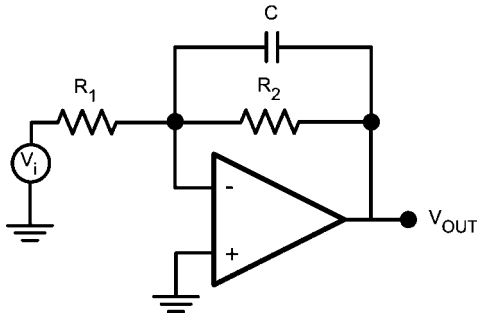

30155547

FIGURE 3. Lowpass Filter

The transfer function can be expressed as follows:

By KCL:

$$\frac{-V_i}{R_1} - \frac{V_O}{\left[\frac{1}{j\omega C}\right]} - \frac{V_O}{R_2} = 0 \quad (7)$$

Simplifying this further results in:

$$V_O = \frac{-R_2}{R_1} \left[ \frac{1}{j\omega C R_2 + 1} \right] V_i \quad (8)$$

or

$$\frac{V_O}{V_i} = \frac{-R_2}{R_1} \left[ \frac{1}{j\omega C R_2 + 1} \right] \quad (9)$$

Now, substituting  $\omega = 2\pi f$ , so that the calculations are in f(Hz) and not  $\omega$ (rad/s), and setting the DC gain  $H_O = -R_2/R_1$  and  $H = V_O/V_i$

$$H = H_O \left[ \frac{1}{j2\pi f C R_2 + 1} \right] \quad (10)$$

Set:  $f_o = 1/(2\pi R_1 C)$

$$H = H_O \left[ \frac{1}{1 + j(f/f_o)} \right] \quad (11)$$

Low pass filters are known as lossy integrators because they only behave as an integrator at higher frequencies. Just by looking at the transfer function one can predict the general form of the bode plot. When the  $f/f_o$  ratio is small, the capacitor is in effect an open circuit and the amplifier behaves at a set DC gain. Starting at  $f_o$ , -3dB corner, the capacitor will have the dominant impedance and hence the circuit will behave as an integrator and the signal will be attenuated and eventually cut. The bode plot for this filter is shown in the following picture:

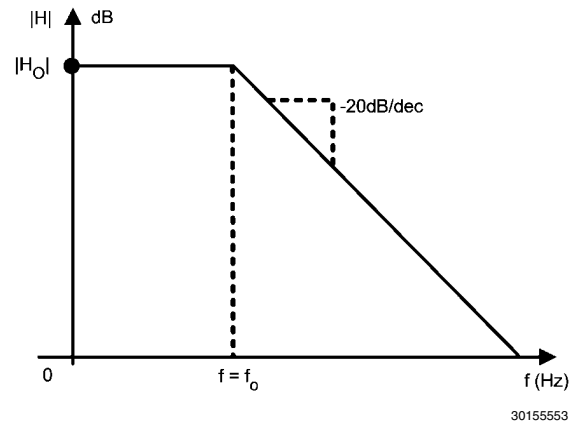

30155553

FIGURE 4. Lowpass Filter Transfer Function

## HIGH PASS FILTER

In a similar approach, one can derive the transfer function of a high pass filter. A typical first order high pass filter is shown below:

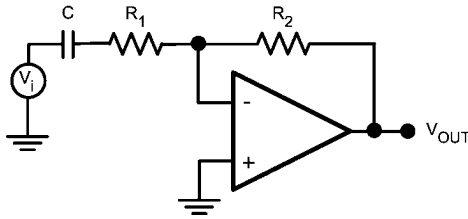

30155554

FIGURE 5. Highpass Filter

Writing the KCL for this circuit :

( $V_1$  denotes the voltage between C and  $R_1$ )

$$\frac{V_1 - V^-}{\frac{1}{j\omega C}} = \frac{V_1 - V^-}{R_1} \quad (12)$$

$$\frac{V^- + V_1}{R_1} = \frac{V^- + V_O}{R_2} \quad (13)$$

Solving these two equations to find the transfer function and using:

$$f_0 = \frac{1}{2\pi R_1 C}$$

$$\text{(high frequency gain)} \quad H_O = \frac{-R_2}{R_1} \quad \text{and} \quad H = \frac{V_O}{V_1}$$

Which results:

$$H = H_O \frac{j(f/f_0)}{1 + j(f/f_0)} \quad (14)$$

Looking at the transfer function, it is clear that when  $f/f_0$  is small, the capacitor is open and hence no signal is getting in to the amplifier. As the frequency increases the amplifier starts operating. At  $f = f_0$  the capacitor behaves like a short circuit and the amplifier will have a constant, high frequency, gain of  $H_O$ . Figure 6 shows the transfer function of this high pass filter:

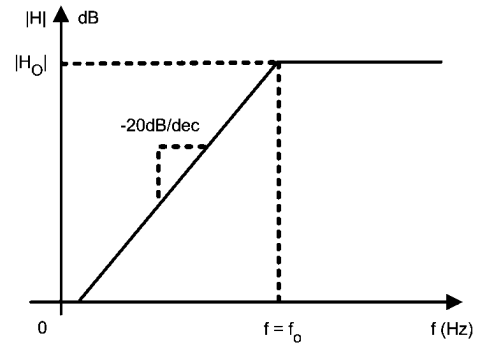

30155558

FIGURE 6. Highpass Filter Transfer Function

## BAND PASS FILTER

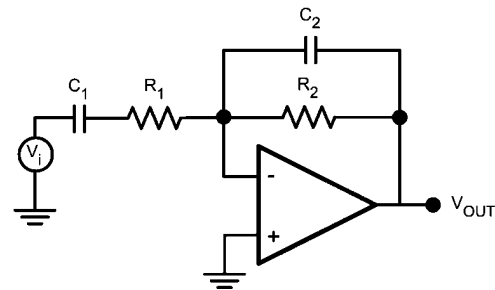

30155560

FIGURE 7. Bandpass Filter

Combining a low pass filter and a high pass filter will generate a band pass filter. In this network the input impedance forms the high pass filter while the feedback impedance forms the low pass filter. Choosing the corner frequencies so that  $f_1 < f_2$ , then all the frequencies in between,  $f_1 \leq f \leq f_2$ , will pass through the filter while frequencies below  $f_1$  and above  $f_2$  will be cut off.

The transfer function can be easily calculated using the same methodology as before.

$$H = H_O \frac{j(f/f_1)}{[1 + j(f/f_1)] [1 + j(f/f_2)]} \quad (15)$$

Where

$$f_1 = \frac{1}{2\pi R_1 C_1}$$

$$f_2 = \frac{1}{2\pi R_2 C_2}$$

$$H_O = \frac{-R_2}{R_1}$$

The transfer function is presented in the following figure.

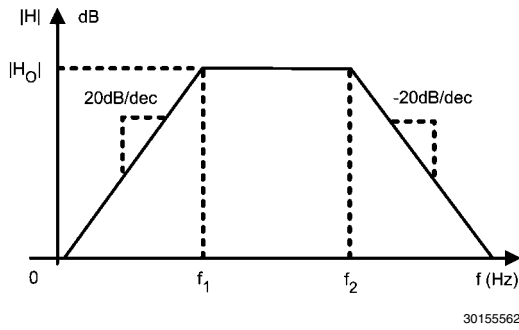

FIGURE 8. Bandpass filter Transfer Function

**STATE VARIABLE ACTIVE FILTER**

State variable active filters are circuits that can simultaneously represent high pass, band pass, and low pass filters. The state variable active filter uses three separate amplifiers to achieve this task. A typical state variable active filter is shown in Figure 9. The first amplifier in the circuit is connected as a gain stage. The second and third amplifiers are connected as integrators, which means they behave as low pass filters. The feedback path from the output of the third amplifier to the first amplifier enables this low frequency signal to be fed back with a finite and fairly low closed loop gain. This is while the high frequency signal on the input is still gained up by the open loop gain of the 1st amplifier. This makes the first amplifier a high pass filter. The high pass signal is then fed into a low pass filter. The outcome is a band pass signal, meaning the second amplifier is a band pass filter. This signal is then fed into the third amplifiers input and so, the third amplifier behaves as a simple low pass filter.

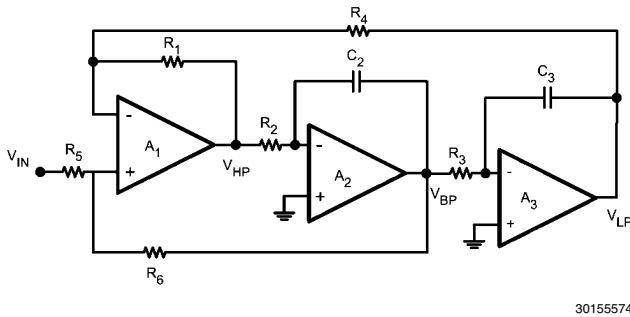
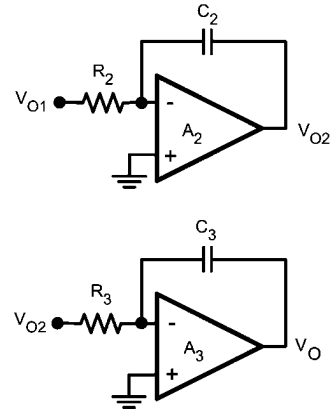
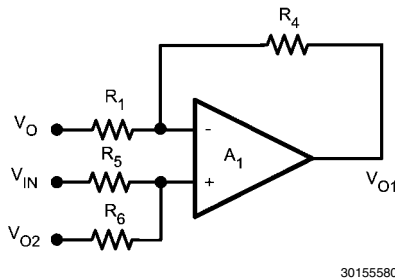

FIGURE 9. State Variable Active Filter

The transfer function of each filter needs to be calculated. The derivations will be more trivial if each stage of the filter is shown on its own.

The three components are:



For A<sub>1</sub> the relationship between input and output is:

$$V_{O1} = \frac{-R_4}{R_1} V_0 + \left[ \frac{R_6}{R_5 + R_6} \right] \left[ \frac{R_1 + R_4}{R_1} \right] V_{IN} + \left[ \frac{R_5}{R_5 + R_6} \right] \left[ \frac{R_1 + R_4}{R_1} \right] V_{O2}$$

This relationship depends on the output of all the filters. The input-output relationship for A<sub>2</sub> can be expressed as:

$$V_{O2} = \frac{-1}{s C_2 R_2} V_{O1}$$

And finally this relationship for A<sub>3</sub> is as follows:

$$V_0 = \frac{-1}{s C_3 R_3} V_{O2}$$

Re-arranging these equations, one can find the relationship between V<sub>0</sub> and V<sub>IN</sub> (transfer function of the lowpass filter), V<sub>O1</sub> and V<sub>IN</sub> (transfer function of the highpass filter), and V<sub>O2</sub> and V<sub>IN</sub> (transfer function of the bandpass filter) These relationships are as follows:

**Lowpass Filter**

$$\frac{V_0}{V_{IN}} = \frac{\left[ \frac{R_1 + R_4}{R_1} \right] \left[ \frac{R_6}{R_5 + R_6} \right] \left[ \frac{1}{C_2 C_3 R_2 R_3} \right]}{s^2 + s \left[ \frac{1}{C_2 R_2} \right] \left[ \frac{R_5}{R_5 + R_6} \right] \left[ \frac{R_1 + R_4}{R_1} \right] + \left[ \frac{1}{C_2 C_3 R_2 R_3} \right]}$$

**Highpass Filter**

$$\frac{V_{O1}}{V_{IN}} = \frac{s^2 \left[ \frac{R_1 + R_4}{R_1} \right] \left[ \frac{R_6}{R_5 + R_6} \right]}{s^2 + s \left[ \frac{1}{C_2 R_2} \right] \left[ \frac{R_5}{R_5 + R_6} \right] \left[ \frac{R_1 + R_4}{R_1} \right] + \left[ \frac{1}{C_2 C_3 R_2 R_3} \right]}$$

## Bandpass Filter

$$\frac{V_{O2}}{V_{IN}} = \frac{s \left[ \frac{1}{C_2 R_2} \right] \left[ \frac{R_1 + R_4}{R_1} \right] \left[ \frac{R_6}{R_5 + R_6} \right]}{s^2 + s \left[ \frac{1}{C_2 R_2} \right] \left[ \frac{R_5}{R_5 + R_6} \right] \left[ \frac{R_1 + R_4}{R_1} \right] + \left[ \frac{1}{C_2 C_3 R_2 R_3} \right]}$$

The center frequency and Quality Factor for all of these filters is the same. The values can be calculated in the following manner:

$$\omega_c = \sqrt{\frac{1}{C_2 C_3 R_2 R_3}}$$

and

$$Q = \sqrt{\frac{C_2 R_2}{C_3 R_3} \left[ \frac{R_5 + R_6}{R_6} \right] \left[ \frac{R_1}{R_1 + R_4} \right]}$$

A design example is shown here:

Designing a bandpass filter with center frequency of 10kHz and Quality Factor of 5.5

To do this, first consider the Quality Factor. It is best to pick convenient values for the capacitors.  $C_2 = C_3 = 1000\text{pF}$ . Also,

choose  $R_1 = R_4 = 30\text{k}\Omega$ . Now values of  $R_5$  and  $R_6$  need to be calculated. With the chosen values for the capacitors and resistors, Q reduces to:

$$Q = \frac{11}{2} = \frac{1}{2} \left[ \frac{R_5 + R_6}{R_6} \right]$$

or

$$R_5 = 10R_6$$

$$R_6 = 1.5\text{k}\Omega$$

$$R_5 = 15\text{k}\Omega$$

Also, for  $f = 10\text{kHz}$ , the center frequency is  $\omega_c = 2\pi f = 62.8\text{kHz}$ .

Using the expressions above, the appropriate resistor values will be  $R_2 = R_3 = 16\text{k}\Omega$ .

The following graphs show the transfer function of each of the filters. The DC gain of this circuit is:

$$\text{DC GAIN} = \left[ \frac{R_1 + R_4}{R_1} \right] \left[ \frac{R_6}{R_5 + R_6} \right] = -14.8 \text{ dB}$$

30155590

**Physical Dimensions** inches (millimeters) unless otherwise noted

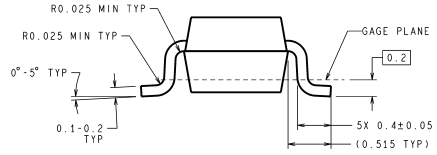
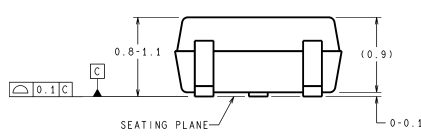
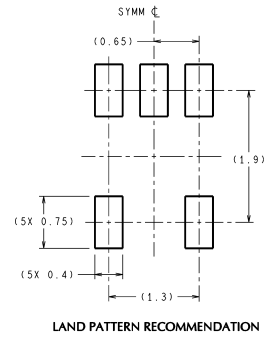
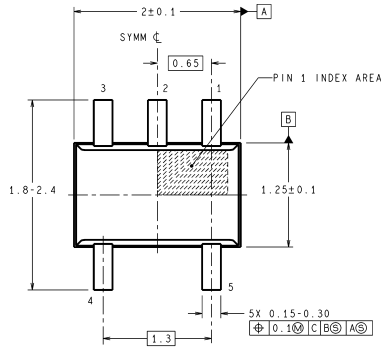

DIMENSIONS ARE IN MILLIMETERS  
DIMENSIONS IN ( ) FOR REFERENCE ONLY

MAA05A (Rev D)

**SC70-5**  
**NS Package Number MAA05A**



## Notes

For more National Semiconductor product information and proven design tools, visit the following Web sites at:  
[www.national.com](http://www.national.com)

Products		Design Support	
Amplifiers	<a href="http://www.national.com/amplifiers">www.national.com/amplifiers</a>	WEBENCH® Tools	<a href="http://www.national.com/webench">www.national.com/webench</a>
Audio	<a href="http://www.national.com/audio">www.national.com/audio</a>	App Notes	<a href="http://www.national.com/appnotes">www.national.com/appnotes</a>
Clock and Timing	<a href="http://www.national.com/timing">www.national.com/timing</a>	Reference Designs	<a href="http://www.national.com/refdesigns">www.national.com/refdesigns</a>
Data Converters	<a href="http://www.national.com/adc">www.national.com/adc</a>	Samples	<a href="http://www.national.com/samples">www.national.com/samples</a>
Interface	<a href="http://www.national.com/interface">www.national.com/interface</a>	Eval Boards	<a href="http://www.national.com/evalboards">www.national.com/evalboards</a>
LVDS	<a href="http://www.national.com/lvds">www.national.com/lvds</a>	Packaging	<a href="http://www.national.com/packaging">www.national.com/packaging</a>
Power Management	<a href="http://www.national.com/power">www.national.com/power</a>	Green Compliance	<a href="http://www.national.com/quality/green">www.national.com/quality/green</a>
Switching Regulators	<a href="http://www.national.com/switchers">www.national.com/switchers</a>	Distributors	<a href="http://www.national.com/contacts">www.national.com/contacts</a>
LDOs	<a href="http://www.national.com/ldo">www.national.com/ldo</a>	Quality and Reliability	<a href="http://www.national.com/quality">www.national.com/quality</a>
LED Lighting	<a href="http://www.national.com/led">www.national.com/led</a>	Feedback/Support	<a href="http://www.national.com/feedback">www.national.com/feedback</a>
Voltage References	<a href="http://www.national.com/vref">www.national.com/vref</a>	Design Made Easy	<a href="http://www.national.com/easy">www.national.com/easy</a>
PowerWise® Solutions	<a href="http://www.national.com/powerwise">www.national.com/powerwise</a>	Applications & Markets	<a href="http://www.national.com/solutions">www.national.com/solutions</a>
Serial Digital Interface (SDI)	<a href="http://www.national.com/sdi">www.national.com/sdi</a>	Mil/Aero	<a href="http://www.national.com/milaero">www.national.com/milaero</a>
Temperature Sensors	<a href="http://www.national.com/tempensors">www.national.com/tempensors</a>	SolarMagic™	<a href="http://www.national.com/solarmagic">www.national.com/solarmagic</a>
PLL/VCO	<a href="http://www.national.com/wireless">www.national.com/wireless</a>	PowerWise® Design University	<a href="http://www.national.com/training">www.national.com/training</a>

THE CONTENTS OF THIS DOCUMENT ARE PROVIDED IN CONNECTION WITH NATIONAL SEMICONDUCTOR CORPORATION ("NATIONAL") PRODUCTS. NATIONAL MAKES NO REPRESENTATIONS OR WARRANTIES WITH RESPECT TO THE ACCURACY OR COMPLETENESS OF THE CONTENTS OF THIS PUBLICATION AND RESERVES THE RIGHT TO MAKE CHANGES TO SPECIFICATIONS AND PRODUCT DESCRIPTIONS AT ANY TIME WITHOUT NOTICE. NO LICENSE, WHETHER EXPRESS, IMPLIED, ARISING BY ESTOPPEL OR OTHERWISE, TO ANY INTELLECTUAL PROPERTY RIGHTS IS GRANTED BY THIS DOCUMENT.

TESTING AND OTHER QUALITY CONTROLS ARE USED TO THE EXTENT NATIONAL DEEMS NECESSARY TO SUPPORT NATIONAL'S PRODUCT WARRANTY. EXCEPT WHERE MANDATED BY GOVERNMENT REQUIREMENTS, TESTING OF ALL PARAMETERS OF EACH PRODUCT IS NOT NECESSARILY PERFORMED. NATIONAL ASSUMES NO LIABILITY FOR APPLICATIONS ASSISTANCE OR BUYER PRODUCT DESIGN. BUYERS ARE RESPONSIBLE FOR THEIR PRODUCTS AND APPLICATIONS USING NATIONAL COMPONENTS. PRIOR TO USING OR DISTRIBUTING ANY PRODUCTS THAT INCLUDE NATIONAL COMPONENTS, BUYERS SHOULD PROVIDE ADEQUATE DESIGN, TESTING AND OPERATING SAFEGUARDS.

EXCEPT AS PROVIDED IN NATIONAL'S TERMS AND CONDITIONS OF SALE FOR SUCH PRODUCTS, NATIONAL ASSUMES NO LIABILITY WHATSOEVER, AND NATIONAL DISCLAIMS ANY EXPRESS OR IMPLIED WARRANTY RELATING TO THE SALE AND/OR USE OF NATIONAL PRODUCTS INCLUDING LIABILITY OR WARRANTIES RELATING TO FITNESS FOR A PARTICULAR PURPOSE, MERCHANTABILITY, OR INFRINGEMENT OF ANY PATENT, COPYRIGHT OR OTHER INTELLECTUAL PROPERTY RIGHT.

#### LIFE SUPPORT POLICY

**NATIONAL'S PRODUCTS ARE NOT AUTHORIZED FOR USE AS CRITICAL COMPONENTS IN LIFE SUPPORT DEVICES OR SYSTEMS WITHOUT THE EXPRESS PRIOR WRITTEN APPROVAL OF THE CHIEF EXECUTIVE OFFICER AND GENERAL COUNSEL OF NATIONAL SEMICONDUCTOR CORPORATION.** As used herein:

Life support devices or systems are devices which (a) are intended for surgical implant into the body, or (b) support or sustain life and whose failure to perform when properly used in accordance with instructions for use provided in the labeling can be reasonably expected to result in a significant injury to the user. A critical component is any component in a life support device or system whose failure to perform can be reasonably expected to cause the failure of the life support device or system or to affect its safety or effectiveness.

National Semiconductor and the National Semiconductor logo are registered trademarks of National Semiconductor Corporation. All other brand or product names may be trademarks or registered trademarks of their respective holders.

Copyright© 2011 National Semiconductor Corporation

For the most current product information visit us at [www.national.com](http://www.national.com)



**National Semiconductor  
Americas Technical  
Support Center**  
Email: [support@nsc.com](mailto:support@nsc.com)  
Tel: 1-800-272-9959

**National Semiconductor Europe  
Technical Support Center**  
Email: [europe.support@nsc.com](mailto:europe.support@nsc.com)

**National Semiconductor Asia  
Pacific Technical Support Center**  
Email: [ap.support@nsc.com](mailto:ap.support@nsc.com)

**National Semiconductor Japan  
Technical Support Center**  
Email: [jpn.feedback@nsc.com](mailto:jpn.feedback@nsc.com)

## IMPORTANT NOTICE

Texas Instruments Incorporated and its subsidiaries (TI) reserve the right to make corrections, modifications, enhancements, improvements, and other changes to its products and services at any time and to discontinue any product or service without notice. Customers should obtain the latest relevant information before placing orders and should verify that such information is current and complete. All products are sold subject to TI's terms and conditions of sale supplied at the time of order acknowledgment.

TI warrants performance of its hardware products to the specifications applicable at the time of sale in accordance with TI's standard warranty. Testing and other quality control techniques are used to the extent TI deems necessary to support this warranty. Except where mandated by government requirements, testing of all parameters of each product is not necessarily performed.

TI assumes no liability for applications assistance or customer product design. Customers are responsible for their products and applications using TI components. To minimize the risks associated with customer products and applications, customers should provide adequate design and operating safeguards.

TI does not warrant or represent that any license, either express or implied, is granted under any TI patent right, copyright, mask work right, or other TI intellectual property right relating to any combination, machine, or process in which TI products or services are used. Information published by TI regarding third-party products or services does not constitute a license from TI to use such products or services or a warranty or endorsement thereof. Use of such information may require a license from a third party under the patents or other intellectual property of the third party, or a license from TI under the patents or other intellectual property of TI.

Reproduction of TI information in TI data books or data sheets is permissible only if reproduction is without alteration and is accompanied by all associated warranties, conditions, limitations, and notices. Reproduction of this information with alteration is an unfair and deceptive business practice. TI is not responsible or liable for such altered documentation. Information of third parties may be subject to additional restrictions.

Resale of TI products or services with statements different from or beyond the parameters stated by TI for that product or service voids all express and any implied warranties for the associated TI product or service and is an unfair and deceptive business practice. TI is not responsible or liable for any such statements.

TI products are not authorized for use in safety-critical applications (such as life support) where a failure of the TI product would reasonably be expected to cause severe personal injury or death, unless officers of the parties have executed an agreement specifically governing such use. Buyers represent that they have all necessary expertise in the safety and regulatory ramifications of their applications, and acknowledge and agree that they are solely responsible for all legal, regulatory and safety-related requirements concerning their products and any use of TI products in such safety-critical applications, notwithstanding any applications-related information or support that may be provided by TI. Further, Buyers must fully indemnify TI and its representatives against any damages arising out of the use of TI products in such safety-critical applications.

TI products are neither designed nor intended for use in military/aerospace applications or environments unless the TI products are specifically designated by TI as military-grade or "enhanced plastic." Only products designated by TI as military-grade meet military specifications. Buyers acknowledge and agree that any such use of TI products which TI has not designated as military-grade is solely at the Buyer's risk, and that they are solely responsible for compliance with all legal and regulatory requirements in connection with such use.

TI products are neither designed nor intended for use in automotive applications or environments unless the specific TI products are designated by TI as compliant with ISO/TS 16949 requirements. Buyers acknowledge and agree that, if they use any non-designated products in automotive applications, TI will not be responsible for any failure to meet such requirements.

Following are URLs where you can obtain information on other Texas Instruments products and application solutions:

### Products

Audio	<a href="http://www.ti.com/audio">www.ti.com/audio</a>
Amplifiers	<a href="http://amplifier.ti.com">amplifier.ti.com</a>
Data Converters	<a href="http://dataconverter.ti.com">dataconverter.ti.com</a>
DLP® Products	<a href="http://www.dlp.com">www.dlp.com</a>
DSP	<a href="http://dsp.ti.com">dsp.ti.com</a>
Clocks and Timers	<a href="http://www.ti.com/clocks">www.ti.com/clocks</a>
Interface	<a href="http://interface.ti.com">interface.ti.com</a>
Logic	<a href="http://logic.ti.com">logic.ti.com</a>
Power Mgmt	<a href="http://power.ti.com">power.ti.com</a>
Microcontrollers	<a href="http://microcontroller.ti.com">microcontroller.ti.com</a>
RFID	<a href="http://www.ti-rfid.com">www.ti-rfid.com</a>
OMAP Mobile Processors	<a href="http://www.ti.com/omap">www.ti.com/omap</a>
Wireless Connectivity	<a href="http://www.ti.com/wirelessconnectivity">www.ti.com/wirelessconnectivity</a>

### Applications

Communications and Telecom	<a href="http://www.ti.com/communications">www.ti.com/communications</a>
Computers and Peripherals	<a href="http://www.ti.com/computers">www.ti.com/computers</a>
Consumer Electronics	<a href="http://www.ti.com/consumer-apps">www.ti.com/consumer-apps</a>
Energy and Lighting	<a href="http://www.ti.com/energy">www.ti.com/energy</a>
Industrial	<a href="http://www.ti.com/industrial">www.ti.com/industrial</a>
Medical	<a href="http://www.ti.com/medical">www.ti.com/medical</a>
Security	<a href="http://www.ti.com/security">www.ti.com/security</a>
Space, Avionics and Defense	<a href="http://www.ti.com/space-avionics-defense">www.ti.com/space-avionics-defense</a>
Transportation and Automotive	<a href="http://www.ti.com/automotive">www.ti.com/automotive</a>
Video and Imaging	<a href="http://www.ti.com/video">www.ti.com/video</a>

TI E2E Community Home Page

[e2e.ti.com](http://e2e.ti.com)

Mailing Address: Texas Instruments, Post Office Box 655303, Dallas, Texas 75265  
Copyright © 2011, Texas Instruments Incorporated