

## CATV Diplex Filter 5-65 / 88-1000 MHz

Released - Rev. V2

### Features

- 75 Ohm
- SMT unit
- RoHS Compliant
- RoHS version of MAFLCT0027

### Description

- M/A-COM Technology Solutions MAFL-007988-CD0550 is a Low Cost, Non Hermetically Sealed surface mount Diplex Filter unit designed for CATV, DTV and DBS applications.



### Ordering Information

Part Number	Package
MAFL-007988-CD0550	50 Piece Reel
MAFL-007988-CD05TB	Customer Test Board

### Recommended Maximum Ratings

Parameter	Value
Storage Temperature	-40°C to +85°C
Operating Temperature	-40°C to +85°C
DC Current	30mA
RF Power	250mW

### Functional Schematic

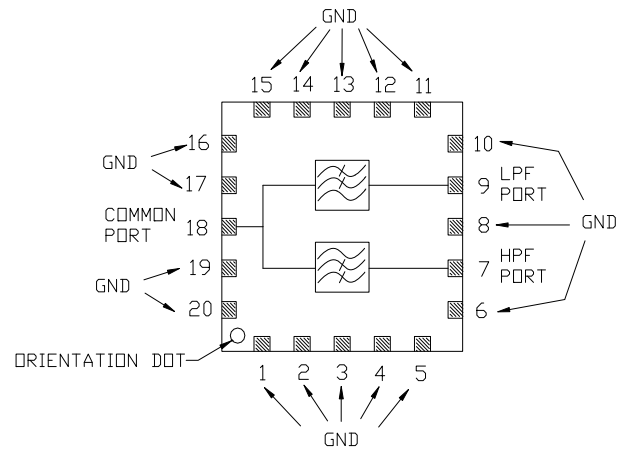

### Electrical Specifications: $T_A = 25^\circ\text{C}$ , $Z_0 = 75\Omega$

Parameter	Units	Min	Typ	Max
<b>Low side to Common</b>				
Insertion Loss				
5 - 65 MHz	dB	-	0.5	1.0
Return Loss				
5 - 65 MHz	dB	17	20	-
Rejection				
88 - 1000 MHz	dB	45	50	-
<b>High side to Common</b>				
Insertion Loss				
88 - 1000 MHz	dB	-	0.5	1.2
Return Loss				
88 - 1000 MHz	dB	17	20	-
Rejection				
5 - 65 MHz	dB	45	50	-
<b>Low side to High side</b>				
Isolation				
5 - 65 MHz	dB	45	50	-
88 - 1000 MHz	dB	45	50	-

### Pin Configuration

Function	Pin Number
Common Port	18
Low Pass Port	9
High Pass Port	7
Ground	1 - 6, 8, 10-17, 19, 20
Not connected	-

## Outline Drawing - SM-85

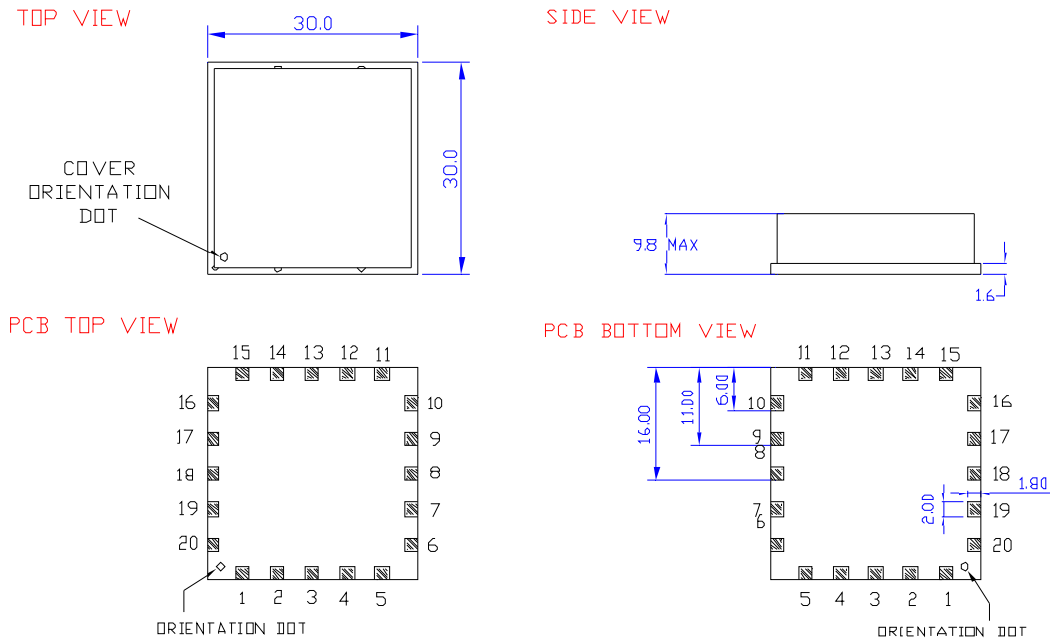

Dimensions in mm

## Recommended PCB Configuration

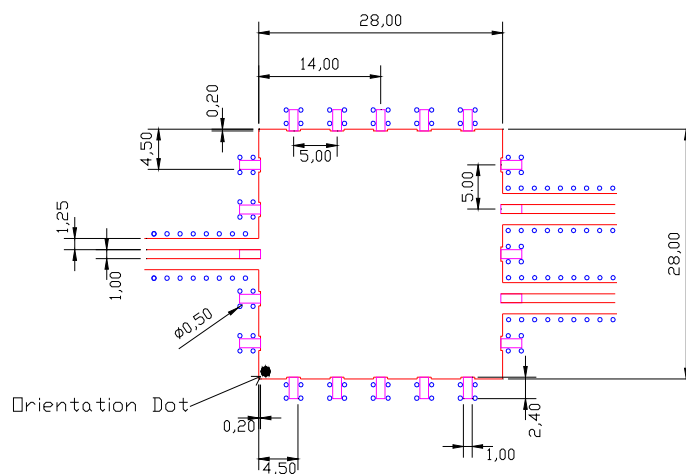

Dimensions in mm

## CATV Diplex Filter 5-65 / 88-1000 MHz

Released - Rev. V2

Typical Performance:  $T_A = 25^\circ\text{C}$ ,  $Z_0 = 75\Omega$

### Low Pass Filter Insertion Loss

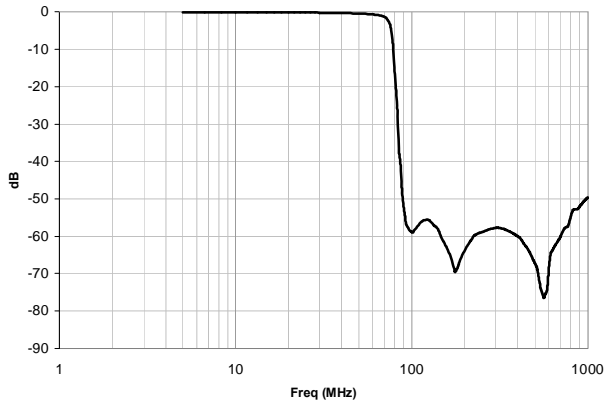

### High Pass Filter Insertion Loss

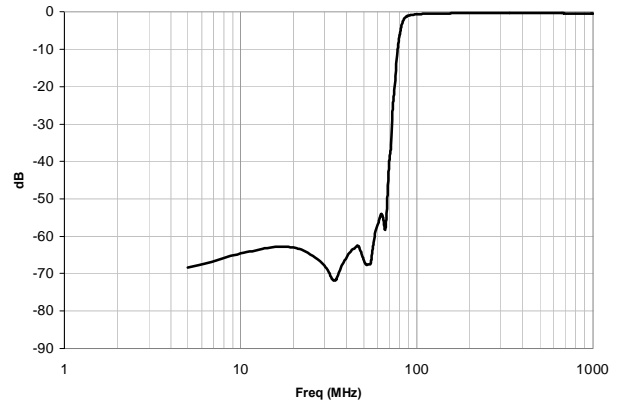

### Low Side to High Side Isolation

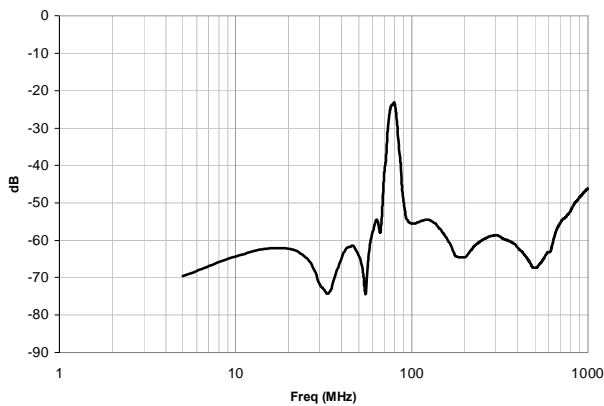

### Input Port Return Loss

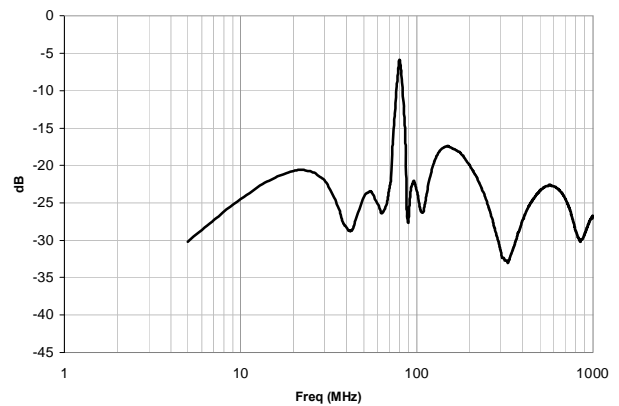

### Low Pass Port Return Loss

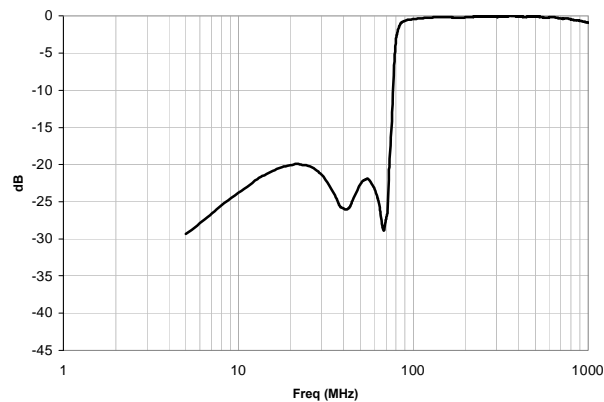

### High Pass Port Return Loss

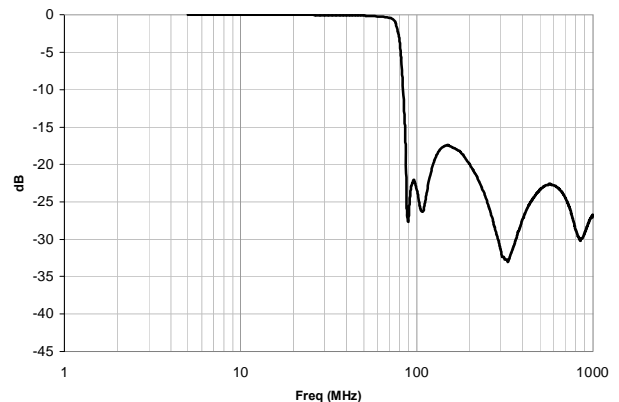

**ADVANCED:** Data Sheets contain information regarding a product M/A-COM Technology Solutions is considering for development. Performance is based on target specifications, simulated results, and/or prototype measurements. Commitment to develop is not guaranteed.

**PRELIMINARY:** Data Sheets contain information regarding a product M/A-COM Technology Solutions has under development. Performance is based on engineering tests. Specifications are typical. Mechanical outline has been fixed. Engineering samples and/or test data may be available. Commitment to produce in volume is not guaranteed.

• **North America** Tel: 800.366.2266 • **Europe** Tel: +353.21.244.6400  
 • **India** Tel: +91.80.4155721 • **China** Tel: +86.21.2407.1588  
 Visit [www.macomtech.com](http://www.macomtech.com) for additional data sheets and product information.

M/A-COM Technology Solutions Inc. and its affiliates reserve the right to make changes to the product(s) or information contained herein without notice.