

# 6MBI100S-140

IGBT Modules

## IGBT MODULE ( S series) 1400V / 100A 6 in one-package

### ■ Features

- Compact Package
- P.C.Board Mount Module
- Low  $V_{CE(sat)}$

### ■ Applications

- Inverter for Motor drive
- AC and DC Servo drive amplifier
- Uninterruptible power supply
- Industrial machines, such as Welding machines

### ■ Maximum ratings and characteristics

#### ● Absolute maximum ratings (at $T_c=25^\circ\text{C}$ unless otherwise specified)

Item	Symbol	Rating	Unit		
Collector-Emitter voltage	$V_{CES}$	1400	V		
Gate-Emitter voltage	$V_{GES}$	$\pm 20$	V		
Collector current	Continuous	$T_j=25^\circ\text{C}$	$I_c$	150	A
		$T_j=75^\circ\text{C}$		100	
	1ms	$T_j=25^\circ\text{C}$	$I_c$ pulse	300	A
		$T_j=75^\circ\text{C}$		200	
			$-I_c$	100	A
	1ms		$-I_c$ pulse	200	A
Max. power dissipation (1 device)	$P_c$	700	W		
Operating temperature	$T_j$	+150	$^\circ\text{C}$		
Storage temperature	$T_{stg}$	-40 to +125	$^\circ\text{C}$		
Isolation voltage *1	$V_{is}$	AC 2500 (1min.)	V		
Screw torque	Mounting *2	3.5	N·m		

\*1: All terminals should be connected together when isolation test will be done.

\*2: Recommendable value : 2.5 to 3.5 N·m (M5)

#### ● Electrical characteristics (at $T_j=25^\circ\text{C}$ unless otherwise specified)

Item	Symbol	Characteristics			Conditions	Unit	
		Min.	Typ.	Max.			
Zero gate voltage collector current	$I_{CES}$	–	–	1.0	$V_{GE}=0\text{V}$ , $V_{CE}=1400\text{V}$	mA	
Gate-Emitter leakage current	$I_{GES}$	–	–	0.2	$V_{CE}=0\text{V}$ , $V_{GE}=\pm 20\text{V}$	$\mu\text{A}$	
Gate-Emitter threshold voltage	$V_{GE(th)}$	5.5	7.2	8.5	$V_{CE}=20\text{V}$ , $I_c=100\text{mA}$	V	
Collector-Emitter saturation voltage	$V_{CE(sat)}$	–	2.4	2.7	$T_j=25^\circ\text{C}$	$V_{GE}=15\text{V}$ , $I_c=100\text{A}$	V
		–	3.0	–	$T_j=125^\circ\text{C}$		
Input capacitance	$C_{ies}$	–	12000	–	$V_{GE}=0\text{V}$	pF	
Output capacitance	$C_{oes}$	–	2500	–	$V_{CE}=10\text{V}$		
Reverse transfer capacitance	$C_{res}$	–	2200	–	$f=1\text{MHz}$		
Turn-on time	$t_{on}$	–	0.35	1.2	$V_{CC}=800\text{V}$ $I_c=100\text{A}$ $V_{GE}=\pm 15\text{V}$ $R_G=12\Omega$	$\mu\text{s}$	
	$t_r$	–	0.25	0.6			
	$t_{r(i)}$	–	0.1	–			
Turn-off time	$t_{off}$	–	0.45	1.0			
	$t_f$	–	0.08	0.3			
Diode forward on voltage	$V_F$	–	2.6	3.4	$T_j=25^\circ\text{C}$	$I_F=100\text{A}$ , $V_{GE}=0\text{V}$	V
		–	2.2	–	$T_j=125^\circ\text{C}$		
Reverse recovery time	$t_{rr}$	–	–	0.35	$I_F=100\text{A}$	$\mu\text{s}$	

#### ● Thermal resistance characteristics

Item	Symbol	Characteristics			Conditions	Unit
		Min.	Typ.	Max.		
Thermal resistance	$R_{th(j-c)}$	–	–	0.18	IGBT	$^\circ\text{C/W}$
	$R_{th(j-c)}$	–	–	0.36	FWD	$^\circ\text{C/W}$
	$R_{th(c-f)*2}$	–	0.05	–	the base to cooling fin	$^\circ\text{C/W}$

\*2 : This is the value which is defined mounting on the additional cooling fin with thermal compound



### ■ Equivalent Circuit Schematic

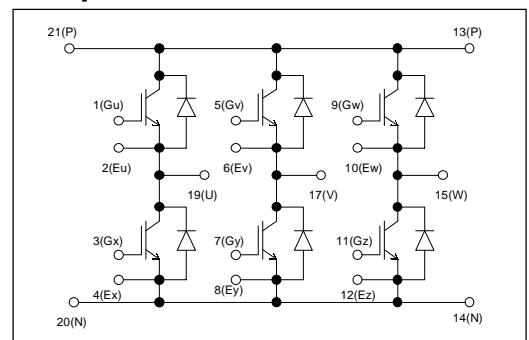

Characteristics

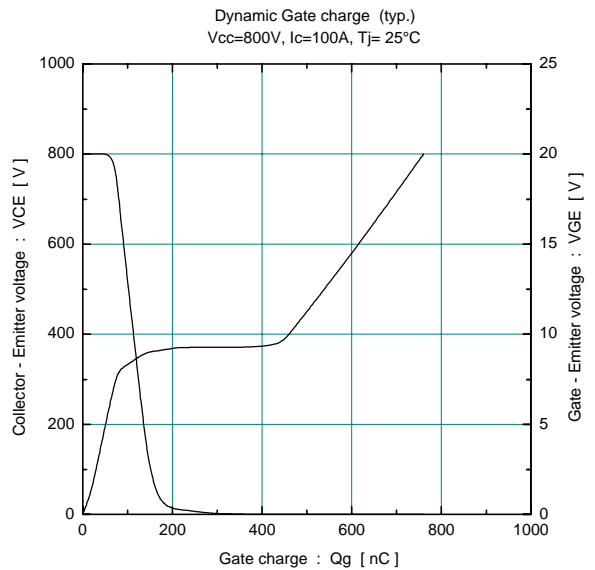
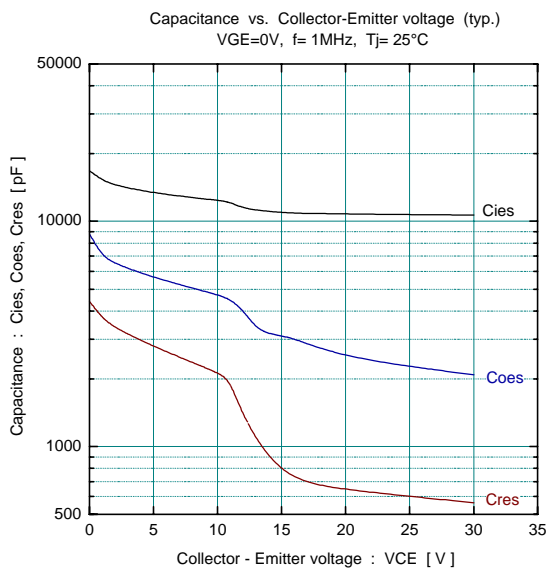
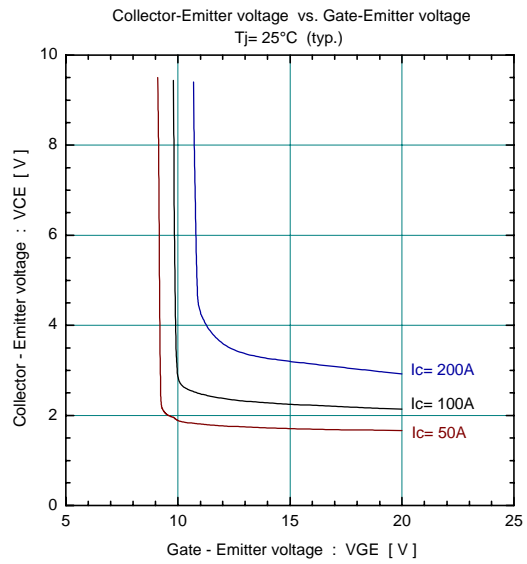
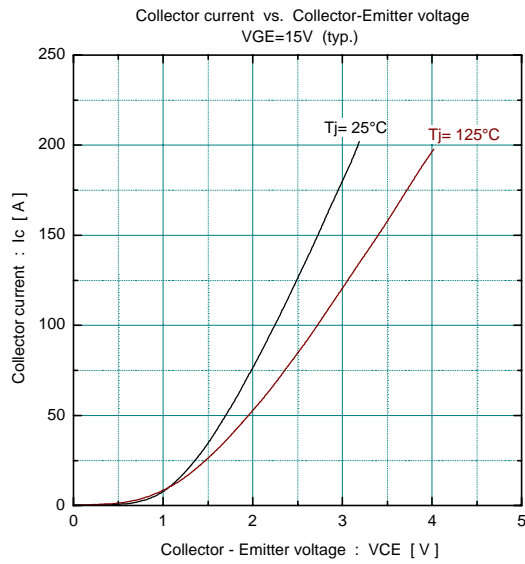
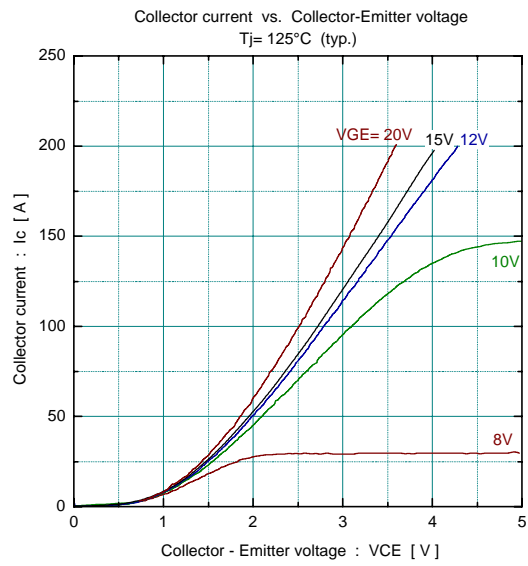
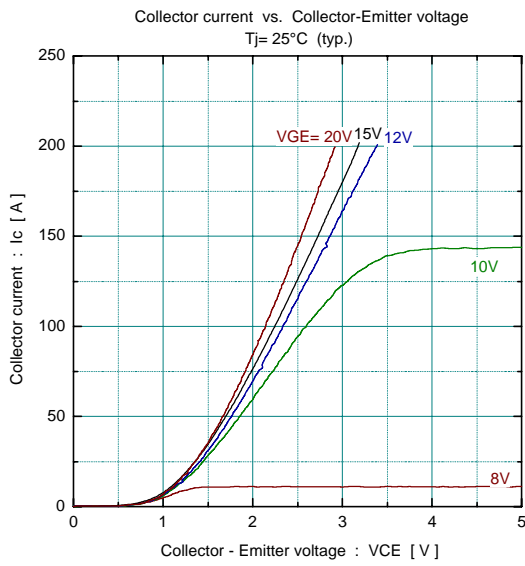

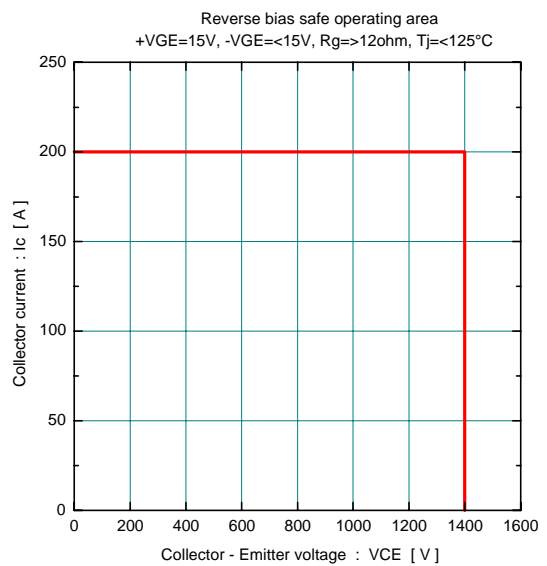
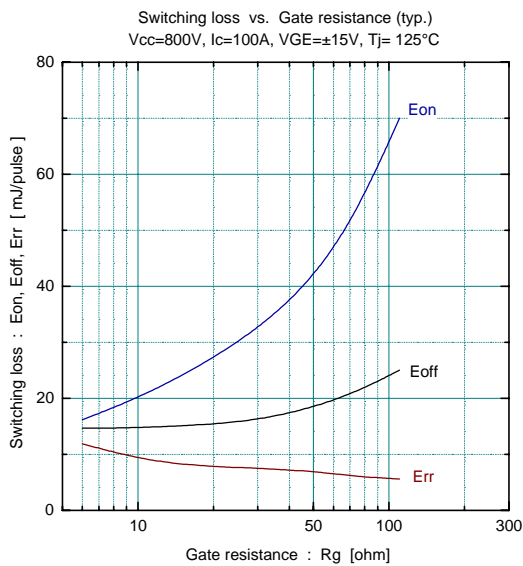
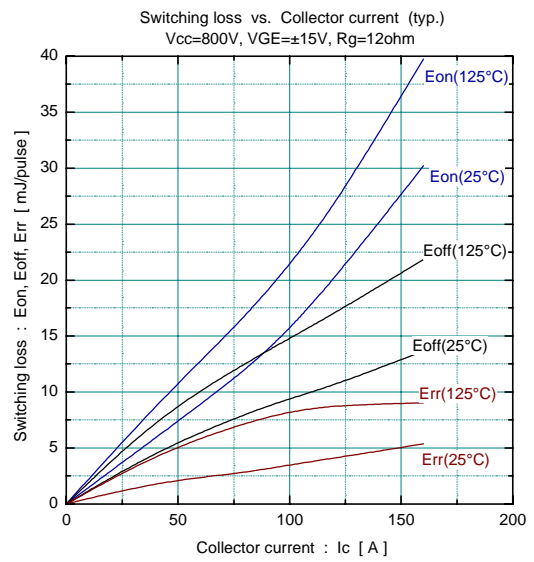
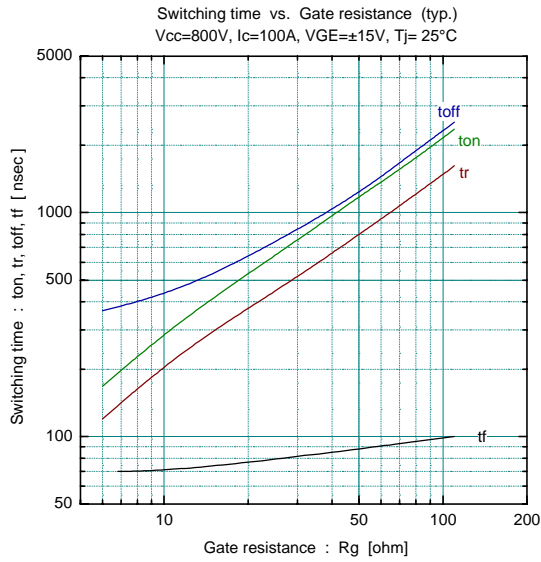
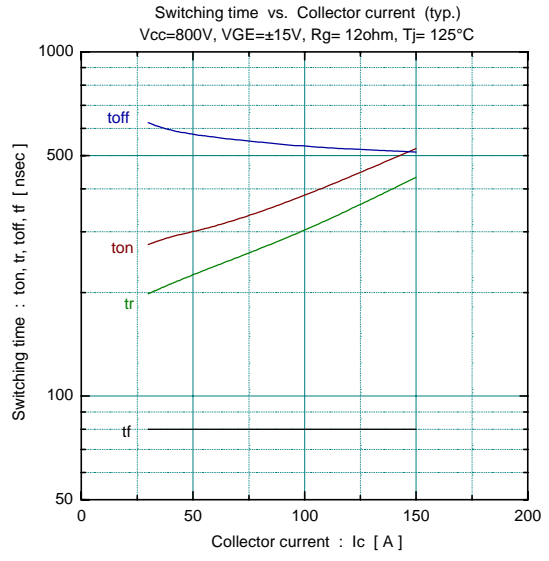
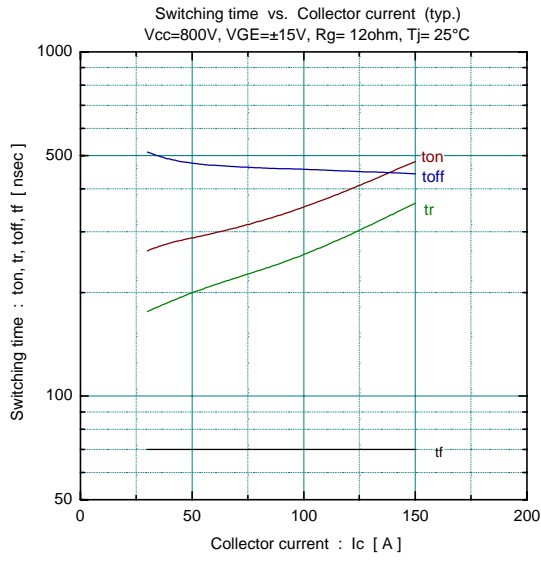

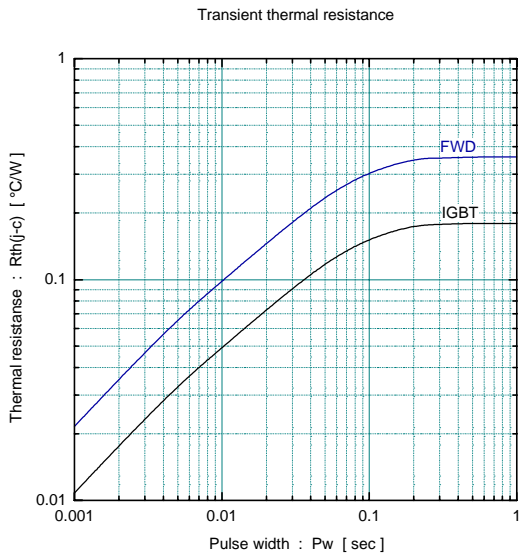
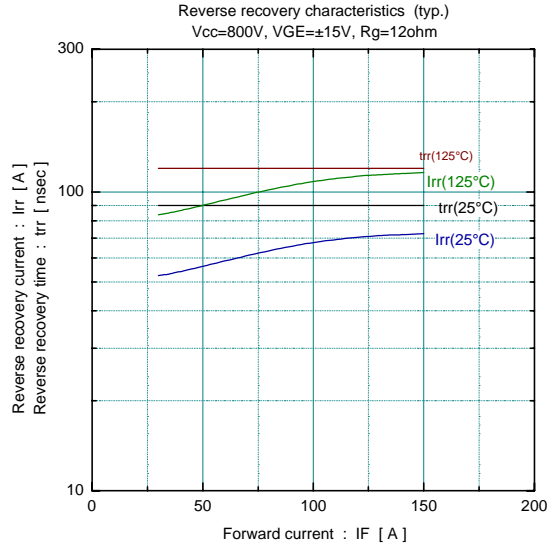
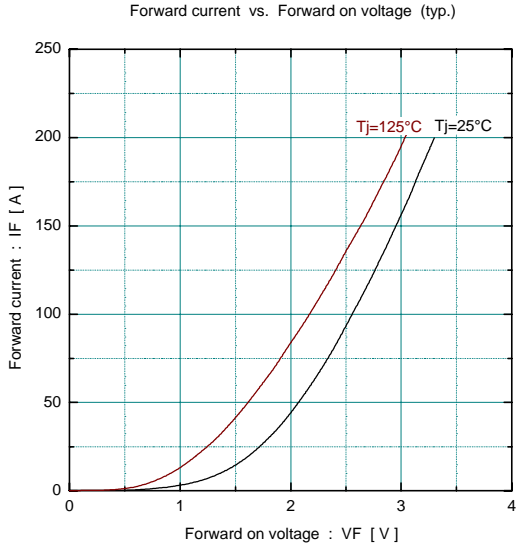

Outline Drawings, mm

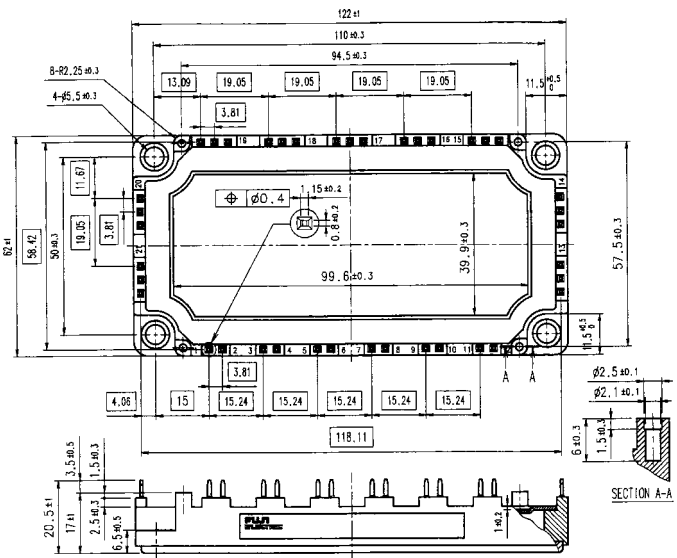

mass : 260g

□ shows theoretical dimension.