

IEC Appliance Inlet C14 with Circuit Breaker TA35 2-pole



See below:
[Approvals and Compliances](#)

Description

- Panel Mount :
 Snap-in version from front side
- 2 Functions :
 Appliance Inlet , Protection class I , Circuit breaker type TA35 , 2-pole
- Quick connect terminal 6.3 x 0.8 mm

Characteristics

- Unwired
- Switch non-illuminated or illuminated
- Suitable for use in equipment according to IEC/UL 60950

Other versions on request

- Pre-wired version
- Quick connect terminals 4.8 x 0.8 mm
- Protection class II, 70°C

References

Alternative: version for 16 A (20 A) [6136](#)
 Substitute for type [7764](#)

Weblinks

[pdf datasheet](#), [html-datasheet](#), [General Product Information](#), [Distributor-Stock-Check](#), [Accessories](#), [Detailed request for product](#), [Microsite](#)

Newly available variants corresponding to V-Lock mating cordset. The connector is equipped with a notch intended for use with the latching cordset. The cord latching system prevents against accidental removal of the cordset.

Technical Data

Ratings IEC	10A / 250VAC; 50Hz
Ratings UL/CSA	15A / 250VAC; 60Hz
Dielectric Strength	> 2.5 kVAC between L-N > 3 kVAC between L/N-PE (1 min/50Hz)
Allowable Operation Temperature	-25 °C to 60 °C
IP-Protection	from front side IP 40 acc. to IEC 60529
Insulation cover	Suitable for appliances with protection class I acc. to IEC 61140
Terminal	Quick connect terminals 6.3 x 0.8 mm
Panel Thickness S	Snap-in 1.5/2/2.5 mm
Material: Housing	Thermoplastic, black, UL 94V-0

appliance inlet/-outlet	C14 acc. to IEC 60320-1 UL 498, CSA C22.2 no. 42 (for cold conditions) pin-temperature 70 °C, 10A, Protection Class I
Circuit Breakers	Acc. IEC/EN 60934, UL 1077, CSA 22.2 no. 235 2-pole rocker switch, illuminated or non-illuminated. Conditional short circuit Inc: 2000 A



Approvals and Compliances

Detailed information on product approvals, code requirements, usage instructions and detailed test conditions can be looked up in [Details about Approvals](#)

Approvals





The approval mark is used by the testing authorities to certify compliance with the safety requirements placed on electronic products.

Approval Reference Type: 6135

Approval Logo	Certificates	Certification Body	Description
	VDE Approvals	VDE	Certificate Number: 40023066
	UL Approvals	UL	UL File Number: E96454
	CQC Approvals	CQC	CCC Certificate Number: 2015180204000152

Product standards

Product standards that are referenced

Organization	Design	Standard	Description
	Designed according to	IEC 60320-1	Appliance couplers for household and similar general purposes
	Designed according to	IEC 60127-6	Miniature fuses. Part 6. Fuse-holders for miniature fuse-links
	Designed according to	IEC 61058-1	Switches for appliances. Part 1. General requirements
	Designed according to	UL 498	Standard for Attachment Plugs and Receptacles
	Designed according to	CSA C22.2 no. 42	General Use Receptacles, Attachment Plugs, and Similar Wiring Devices





Application standards

Application standards where the product can be used

Organization	Design	Standard	Description
	Designed for applications acc.	IEC/UL 60950	IEC 60950-1 includes the basic requirements for the safety of information technology equipment.

Compliances

The product complies with following Guide Lines

Identification	Details	Initiator	Description
	CE declaration of conformity	SCHURTER AG	The CE marking declares that the product complies with the applicable requirements laid down in the harmonisation of Community legislation on its affixing in accordance with EU Regulation 765/2008.
	RoHS	SCHURTER AG	EU Directive RoHS 2011/65/EU
	China RoHS	SCHURTER AG	The law SJ / T 11363-2006 (China RoHS) has been in force since 1 March 2007. It is similar to the EU directive RoHS.
	REACH	SCHURTER AG	On 1 June 2007, Regulation (EC) No 1907/2006 on the Registration, Evaluation, Authorization and Restriction of Chemicals 1 (abbreviated as "REACH") entered into force.
	MicrositeV-Lock	SCHURTER AG	V-Lock system are based on a matching plug-dose combination. The connector is equipped with a notch intended for use with the latching cordset. The cord latching system prevents against accidental removal of the cordset.

Dimensions [mm]

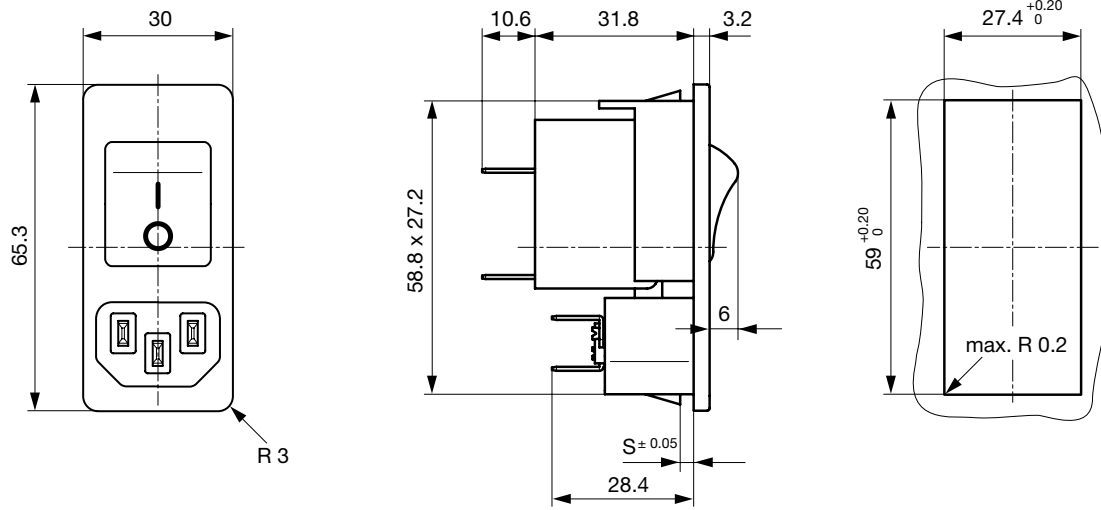

Diagrams

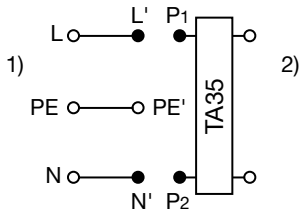

- 1) Line
- 2) Load

ORDER CODE

Table 1 Selection for type TA35

Order example

Number of switched poles Number of protected poles		2-pole	
		1	2
Switch	without illumination	CBT	CBD
Switch	illuminated 240 V 120 V	C12 C14	C32 C34

Other versions on request

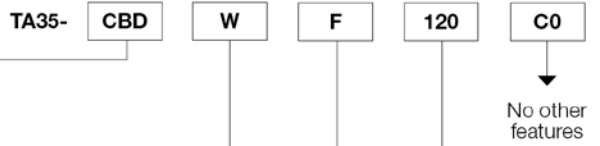

Colours

	Switch front	Rocker	
		non-illuminated	illuminated
W	black	white	-
B	black	black	-
3	black	-	red transparent
4	black	-	green transparent
6	black	-	orange transparent

Other colours on request

Rocker legend

	Surface	Illustration	Colour of print
F	embossed		
H	printed		white
K	printed		black
L	printed		white
M	printed		black

Other legends on request

Position of the rocker legend e.g. F

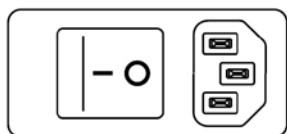

Rated current I_n (A)

I _n	Code	I _n	Code
1,0	J10	8,0	080
2,0	J20	10,0	100
4,0	040	12,0	120*
5,0	050	15,0	150*
6,0	060		

Other rated currents on request *) UL / CSA only

Technical data (continued)

Circuit breaker

Tripping characteristics
 $I_n < 3 \text{ A}$

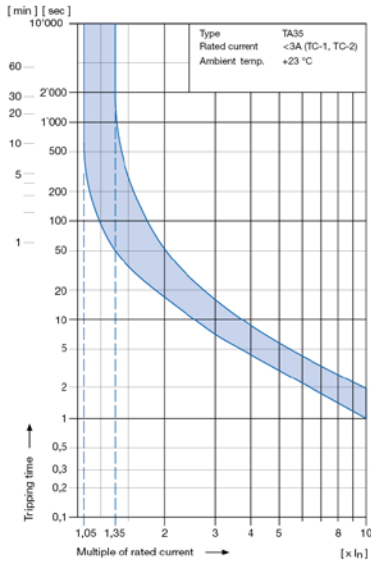

Tripping characteristics
 $I_n \geq 3 \dots 15 \text{ A}$

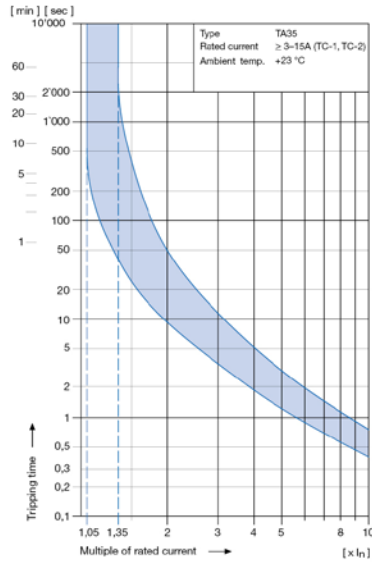

The above tripping characteristics apply to symmetrical overloads on the two poles.

At asymmetric overloads on two pole types the tripping current will be increased by factor **1.05** (TC-2).

Effect of ambient temperature

The unit is calibrated for an ambient temperature of +23 °C. To determine the rated current for lower or higher ambient temperature, use a correction factor from the table below.

* Temperature must be measured at the rear of the breaker next to the terminals after equipment operating temperature has been reached.

* Ambient temperature [°C]	Correction factor
-25	0.79
-20	0.81
0	0.90
+23	1.00
+40	1.03
+50	1.04
+60	1.06

Example:
 Rated current at +23 °C 10 A
 Ambient temperature +60 °C
 Correction factor 1.06
 Chosen rated current at +60 °C
 ambient temperature: **10 A x 1.06 = 10.6 A**

Order code (Order example)

Type	Order code TA35	Specials 21 V-Lock-Notch Wiring 1 wired 0 unwired Terminals 1 Quick connect 6.3 x 0.8 mm Mounting 2 Snap-in s = 1.5 mm 3 Snap-in s = 2.0 mm 4 Snap-in s = 2.5 mm 0 Protection class 1
6135	C B D W F 1 2 0 C 0 see table 1	

. 0 2 1 0 . 2 1

Please note that Schurter will establish an internal part number for logistics use in addition to the order code. The format of this internal part number is, for example: 6135.xxxx.xxxx

Packaging unit 40 Pcs

Accessories

Description

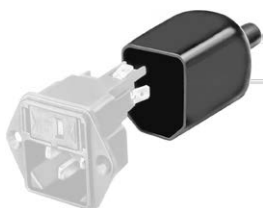

Assorted Covers
Rear Cover

0859.0074



Cord retaining kits
Cord retaining strain relief

Flat head, A

4700.0001

Mating Outlets/Connectors

Category / Description



Appliance Outlet Overview complete

IEC Appliance Outlet F, Screw-on Mounting, Front Side, Solder Terminal

4787

IEC Appliance Outlet F, Snap-in Mounting, Front Side, Solder or Quick-connect Terminal

4788

Appliance Outlet further types to 6135

Connector Overview complete



4782 Mounting: Power Cord, 3 x 1 mm² / 3 x 18 AWG, Cable, Connector: IEC C13

4782

4022 Mounting: Power Supply Cord, 3 x 1.5 mm², Screw clamps, Connector: IEC C13

4022

4785 Mounting: Power Cord, 3 x 1 mm² / 3 x 18 AWG, Cable, Connector: IEC C13

4785

4300-06 Mounting: Power Cord, 3 x 1 mm² / 3 x 18 AWG, Cable, Connector: IEC C13

4300-06

4012 Mounting: Power Supply Cord, 3 x 1.5 mm², Screw clamps, Connector: IEC C13

4012

Connector further types to 6135

...

Mating Outlets/Connectors shuttered



Power Cord Overview complete

VAC13KS, Overview, diverse Connector IEC C13, cord end:

VAC13KS

Power Cord further types to 6135