

Features

- Complete video fader
- 0.02%/0.04° differential gain/phase @100% gain
- Output amplifier included
- Calibrated linear gain control
- ±5V to ±15V operation
- 60 MHz bandwidth
- Low thermal errors

Applications

- Video faders/wipers
- Gain control
- Video text insertion
- Level adjust
- Modulation

Ordering Information

Part No.	Temp. Range	Package	Outline #
EL4094CN	-40°C to +85°C	8-Pin P-DIP	MDP0031
EL4094CS	-40°C to +85°C	8-Pin SO	MDP0027

General Description

The EL4094C is a complete two-input fader. It combines two inputs according to the equation:

$$V_{OUT} = V_{INA} (0.5V + Vg) + V_{INB} (0.5V - Vg),$$

where V_{GAIN} is the difference between V_{GAIN} and $\overline{V_{GAIN}}$ pin voltages and ranges from -0.5V to +0.5V. It has a wide 60 MHz bandwidth at -3 dB, and is designed for excellent video distortion performance. The EL4094C is the same circuit as the EL4095, but with feedback resistors included on-chip to implement unity-gain connection. An output buffer is included in both circuits.

The gain-control input is also very fast, with a 20 MHz small-signal bandwidth and 70 ns recovery time from overdrive.

The EL4094C is compatible with power supplies from ±5V to ±15V, and is available in both the 8-pin plastic DIP and SO-8.

Connection Diagram

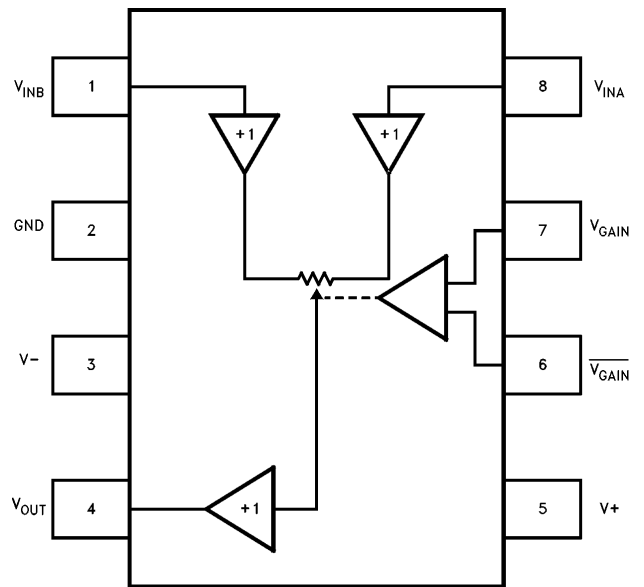

4094-1

Manufactured under U.S. Patent No. 5,321,371, 5,374,898

Note: All information contained in this data sheet has been carefully checked and is believed to be accurate as of the date of publication; however, this data sheet cannot be a "controlled document". Current revisions, if any, to these specifications are maintained at the factory and are available upon your request. We recommend checking the revision level before finalization of your design documentation.

EL4094C

Video Gain Control/Fader

Absolute Maximum Ratings ($T_A = 25^\circ\text{C}$)

V_{S^+}	Voltage between V_{S^+} and GND	+18V	I_{OUT}	Output Current	$\pm 35\text{ mA}$
V_S	Voltage between V_{S^+} and V_{S^-}	+33V		Internal Power Dissipation	See Curves
V_{INA}	Input Voltage	$(V_{S^-}) - 0.3V$	T_A	Operating Ambient Temp. Range	-40°C to $+85^\circ\text{C}$
V_{INB}		to $(V_{S^+}) + 0.3V$	T_J	Operating Junction Temperature	150°C
V_{GAIN}	Input Voltage	$\overline{V_{GAIN}} \pm 0.5V$	T_{ST}	Storage Temperature Range	-65°C to $+150^\circ\text{C}$
$\overline{V_{GAIN}}$	Input Voltage	V_{S^-} to V_{S^+}			

Important Note:

All parameters having Min/Max specifications are guaranteed. The Test Level column indicates the specific device testing actually performed during production and Quality inspection. Elantec performs most electrical tests using modern high-speed automatic test equipment, specifically the LTX77 Series system. Unless otherwise noted, all tests are pulsed tests, therefore $T_J = T_C = T_A$.

Test Level	Test Procedure
I	100% production tested and QA sample tested per QA test plan QCX0002.
II	100% production tested at $T_A = 25^\circ\text{C}$ and QA sample tested at $T_A = 25^\circ\text{C}$, T_{MAX} and T_{MIN} per QA test plan QCX0002.
III	QA sample tested per QA test plan QCX0002.
IV	Parameter is guaranteed (but not tested) by Design and Characterization Data.
V	Parameter is typical value at $T_A = 25^\circ\text{C}$ for information purposes only.

Open Loop DC Electrical Characteristics

$V_S = \pm 5V$, $T_A = 25^\circ\text{C}$, $V_{GAIN} = +0.6V$ to measure channel A, $V_{GAIN} = -0.6V$ to measure channel B, $\overline{V_{GAIN}} = 0V$, unless otherwise specified

Parameter	Description	Limits			Test Level	Units
		Min	Typ	Max		
V_{OS}	Input Offset Voltage		4	30	I	mV
I_{B^+}	V_{IN} Input Bias Current		2	10	I	μA
PSRR	Power Supply Rejection Ratio	60	80		I	dB
EG	Gain Error, 100% Setting		-0.5	-0.8	I	%
V_{IN}	V_{IN} Range	$(V^-) + 2.5$		$(V^+) - 2.5$	I	V
V_O	Output Voltage Swing	$(V^-) + 2.5$		$(V^+) - 2.5$	I	V
I_{SC}	Output Short-Circuit Current	50	95	150	I	mA
$V_{GAIN, 100\%}$	Minimum Voltage at V_{GAIN} for 100% Gain	0.45	0.5	0.55	I	V
$V_{GAIN, 0\%}$	Maximum Voltage at V_{GAIN} for 0% Gain	-0.55	-0.5	-0.45	I	V
NL, Gain	Gain Control Non-linearity, $V_{IN} = \pm 0.5V$		1.5	4	I	%
NL, $A_V = 1$	Signal Non-linearity, $V_{IN} = 0$ to $\pm 1V$, $V_{GAIN} = 0.55V$		0.01		V	%
$A_V = 0.5$	Signal Non-linearity, $V_{IN} = 0$ to $\pm 1V$, $V_{GAIN} = 0V$		0.05		V	%
$A_V = 0.25$	Signal Non-linearity, $V_{IN} = 0$ to $\pm 1V$, $V_{GAIN} = -0.25V$		0.2	0.5	I	%
R_{GAIN}	Resistance between V_{GAIN} and $\overline{V_{GAIN}}$	4.6	5.5	6.6	I	k Ω
I_S	Supply Current	12	14.5	19	I	mA
F_T	Off-Channel Feedthrough		-75	-50	I	dB

EL4094C

Video Gain Control/Fader

Closed Loop AC Electrical Characteristics

$V_S = \pm 15V$, $C_L = 15 \text{ pF}$, $T_A = 25^\circ\text{C}$, $A_V = 100\%$ unless otherwise noted

Parameter	Description	Limits			Test Level	Units
		Min	Typ	Max		
SR	Slew Rate; V_{OUT} from $-3V$ to $+3V$ measured at $-2V$ and $+2V$	370	500		V	$V/\mu s$
BW	Bandwidth, -3 dB -1 dB -0.1 dB	45	60		III	MHz
			35		V	MHz
			6		V	MHz
dG	Differential Gain, AC amplitude of 286 mV_{p-p} at 3.58 MHz on DC offset of $-0.7, 0,$ and $+0.7V$ $A_V = 100\%$ $A_V = 50\%$ $A_V = 25\%$		0.02		V	%
			0.20		V	%
			0.40		V	%
$d\theta$	Differential Phase, AC amplitude of 286 mV_{p-p} at 3.58 MHz on DC offset of $-0.7, 0,$ and $+0.7V$ $A_V = 100\%$ $A_V = 50\%$ $A_V = 25\%$		0.04		V	($^\circ$)
			0.20		V	($^\circ$)
			0.20		V	($^\circ$)
BW, GAIN	-3 dB Gain Control Bandwidth, V_{GAIN} Amplitude $0.5 V_{p-p}$		20		V	MHz
$T_{REC, GAIN}$	Gain Control Recovery from Overload; V_{GAIN} from $-0.6V$ to $0V$		70		V	ns

Typical Performance Curves

Small-Signal Step
Response for Gain = 100%, 50%,
25%, and 0%. $V_S \pm 5V$

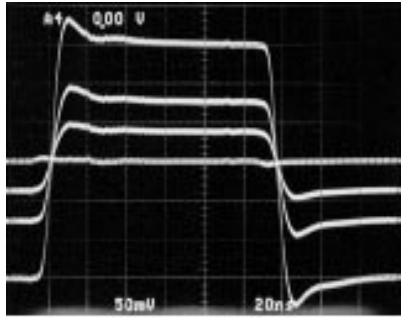

4094-2

Large-Signal Step
Response for Gain = 100%, 50%,
25%, and 0%. $V_S \pm 12V$

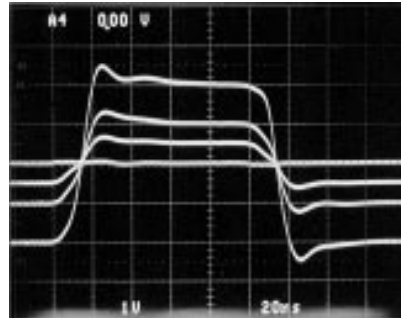

4094-3

EL4094C

Video Gain Control/Fader

Typical Performance Curves — Contd.

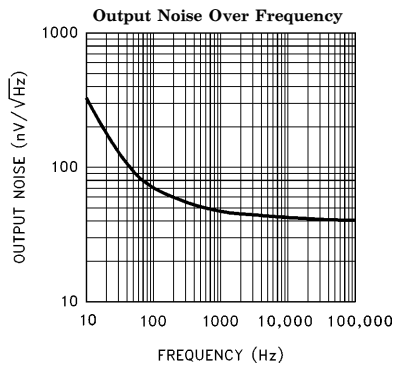
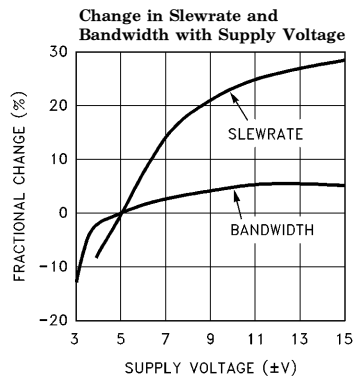
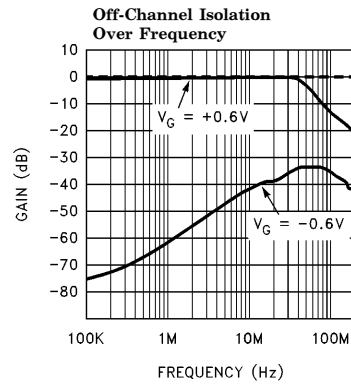
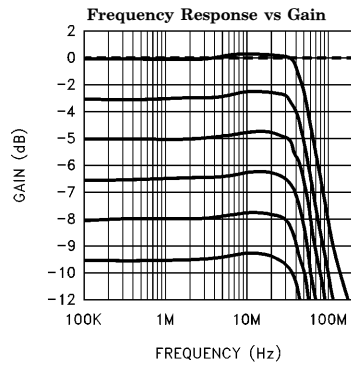
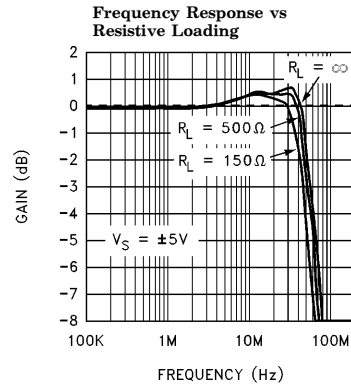
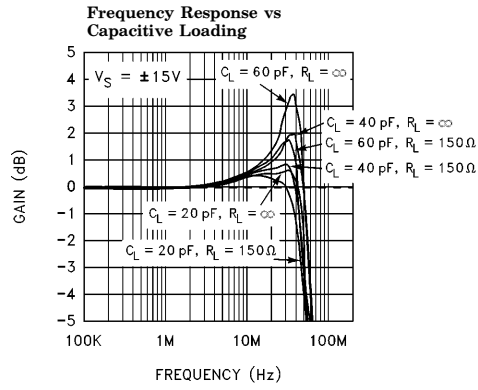

4094-4

EL4094C

Video Gain Control/Fader

Typical Performance Curves — Contd.

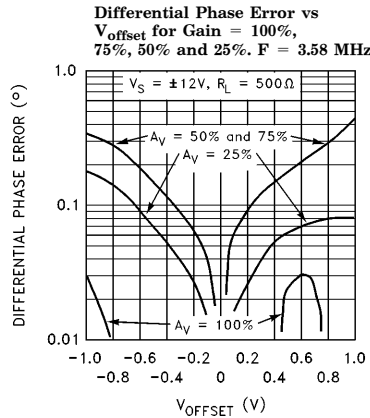
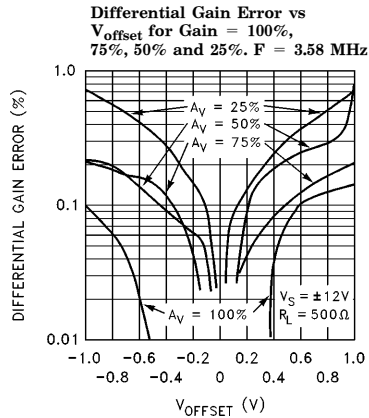
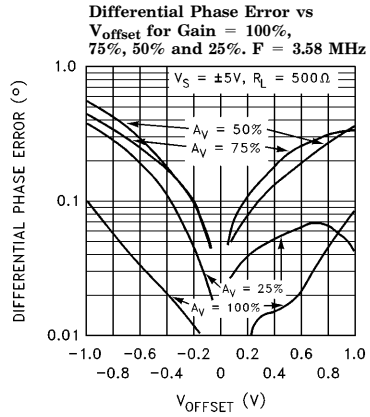
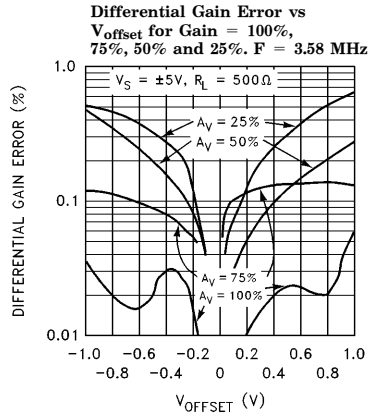
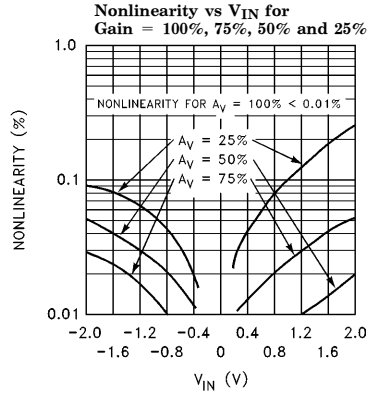
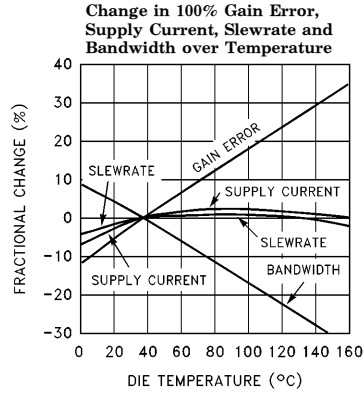

4094-5

EL4094C

Video Gain Control/Fader

Typical Performance Curves — Contd.

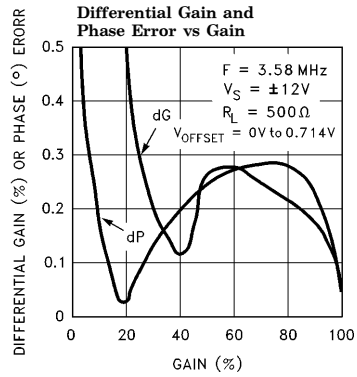
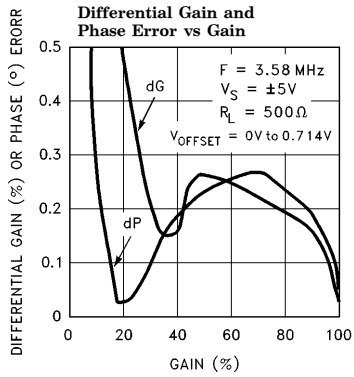

4094-6

Gain vs V_G . $1V_{DC}$ at V_{INA}

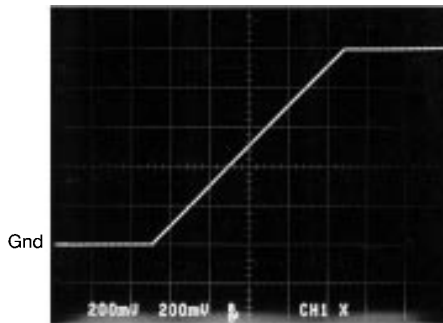

4094-7

Cross-Fade Balance. $V_{INA} = V_{INB} = 0 \text{ V}$

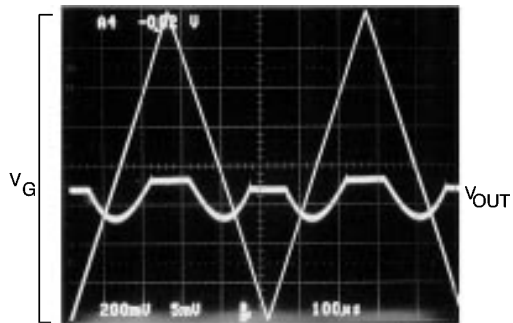

4094-8

Gain Control Response to a Non-Overloading Step, Constant Sinewave at V_{INA}

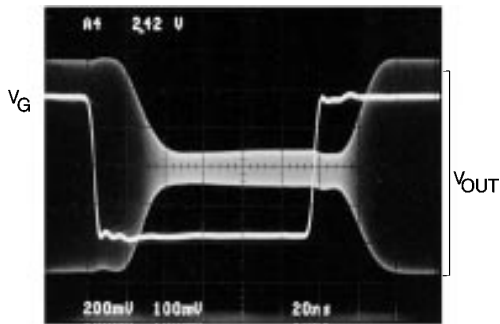

4094-9

V_{GAIN} Overload Recovery Response

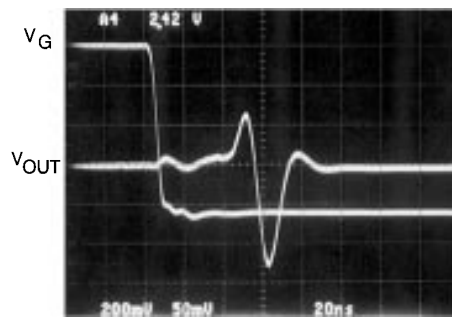

4094-10

EL4094C

Video Gain Control/Fader

Typical Performance Curves — Contd.

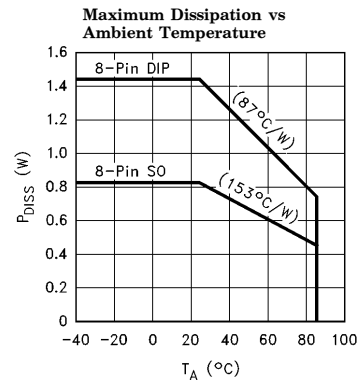
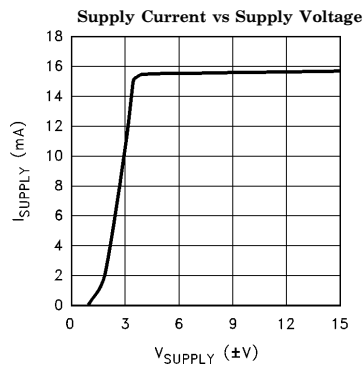
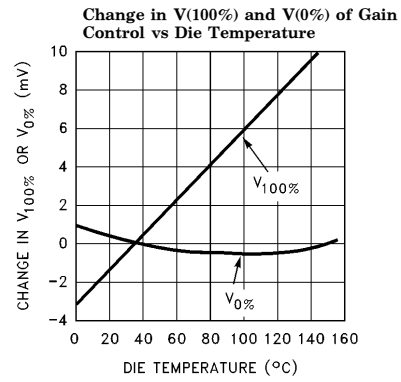
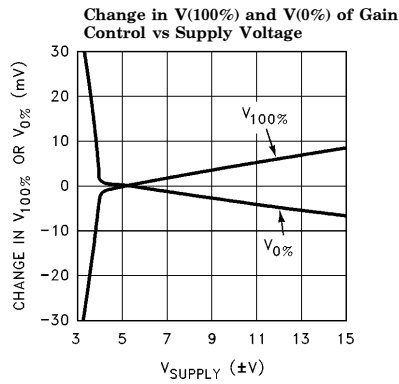
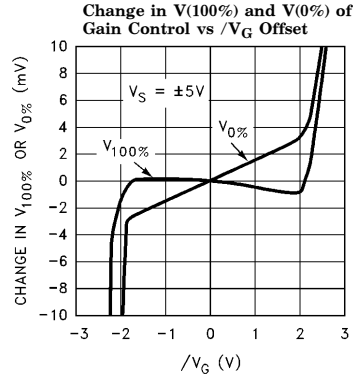
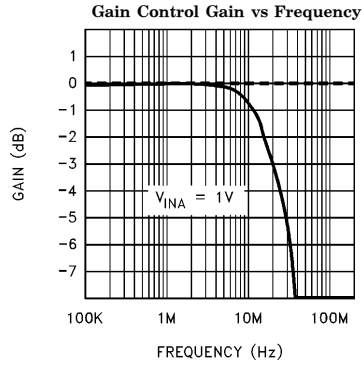

4094-11

EL4094C

Video Gain Control/Fader

Applications Information

The EL4094 is a self-contained and calibrated fader subsystem. When a given channel has 100% gain the circuit behaves as a current-feedback amplifier in unity-gain connection. As such, video and transfer distortions are very low. As the gain of the input is reduced, a 2-quadrant multiplier is gradually introduced into the signal path and distortions increase with reducing gain.

The input impedance also changes with gain setting, from about $1\text{ M}\Omega$ at 100% gain down to $16\text{ k}\Omega$ at zero gain. To maximize gain accuracy and linearity, the inputs should be driven from source impedances of 500Ω or less.

Linearity

The EL4094 is designed to work linearly with $\pm 2\text{V}$ inputs, but lowest distortion occurs at $\pm 1\text{V}$ levels and below. Errors are closer to those of a good current-feedback amplifier above 90% gain.

Low-frequency linearity is 0.1% or better for gains 25% to 100% and inputs up to 1V. NTSC differential gain and phase errors are better than 0.3% and 0.3° for the 25% to 100% gain range. These distortions are not strongly affected by supply voltage nor output loading, at least down to 150Ω . For settling to 0.1%, however, it is best to not load the output heavily and to run the EL4094 on the lowest practical supply voltages, so that thermal effects are minimized.

Gain Control Inputs

The gain control inputs are differential and may be biased at any voltage as long as $/V_{\text{GAIN}}$ is less than 2.5V below $V+$ and 3V above $V-$. The differential input impedance is $5.5\text{ k}\Omega$, and the common-mode impedance is more than $500\text{ k}\Omega$. With zero differential voltage on the gain inputs, both signal inputs have a 50% gain factor. Nominal calibration sets the 100% gain of V_{INA} input at $+0.5\text{V}$ of gain control voltage, and 0% at -0.5V of gain control. V_{INB} 's gain is complementary to that of V_{INA} ; $+0.5\text{V}$ of gain control sets 0% gain at V_{INB} and -0.5V gain control sets 100% V_{INB} gain. The gain control does not have a completely abrupt transition at the 0% and 100% points. There is about 10 mV of "soft" transfer at the gain endpoints. To obtain the most accurate 100% gain factor or best attenuation at 0% gain,

it is necessary to overdrive the gain control input by 30 mV or more. This would set the gain control voltage range as -0.565V to $+0.565\text{V}$, or 30 mV beyond the maximum guaranteed 0% to 100% range. In fact, the gain control inputs are very complex. Here is a representation of the terminals:

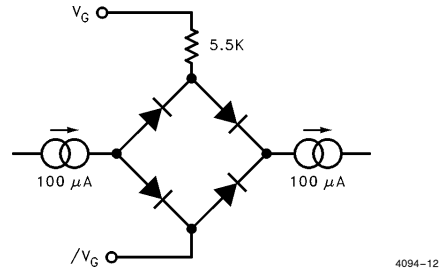

Representation of Gain Control Inputs V_G and $/V_G$

For gain control inputs between $\pm 0.5\text{V}$ ($\pm 90\text{ }\mu\text{A}$), the diode bridge is a low impedance and all of the current into V_g flows back out through $/V_g$. When gain control inputs exceed this amount, the bridge becomes a high impedance as some of the diodes shut off, and the V_g impedance rises sharply from the nominal $5.5\text{K}\Omega$ to about $500\text{K}\Omega$. This is the condition of gain control overdrive. The actual circuit produces a much sharper overdrive characteristic than does the simple diode bridge of this representation.

The gain input has a 20 MHz -3 dB bandwidth and 17 ns risetime for inputs to $\pm 0.45\text{V}$. When the gain control voltage exceeds the 0% or 100% values, a 70 ns overdrive recovery transient will occur when it is brought back to linear range. If quicker gain overdrive response is required, the Force control inputs of the EL4095 can be used.

Output Loading

The EL4094 does not work well with heavy capacitive loads. Like all amplifier outputs, the output impedance becomes inductive over frequency resonating with a capacitive load. The effective output inductance of the EL4094 is about 350 nH. More than 50 pF will cause excessive frequency response peaking and transient ringing. The problem can be solved by inserting a low-value resistor in series with the load, 22Ω or more. If a series resistance cannot be used, then adding a 300Ω or less load resistor to ground or a "snubber" network may help. A snubber is a re-

EL4094C

Video Gain Control/Fader

Applications Information — Contd.
resistor in series with a capacitor, 150 Ω and 100 pF being typical values. The advantage of a snubber is that it does not draw DC load current.

Unterminated coaxial line loads can also cause resonances, and they should be terminated either at the far end or a series back-match resistor installed between the EL4094 and the cable.

The output stage can deliver up to 140 mA into a short-circuit load, but it is only rated for a continuous 35 mA. More continuous current can cause reliability problems with the on-chip metal interconnect. Video levels and loads cause no problems at all.

Noise

The EL4094 has a very simple noise characteristic: the output noise is constant (40 nV/ $\sqrt{\text{Hz}}$ wideband) for all gain settings. The input-referred noise is then the output noise divided by the gain. For instance, at a gain of 50% the input noise is 40 nV/ $\sqrt{\text{Hz}/0.5}$, or 80 nV/ $\sqrt{\text{Hz}}$.

Bypassing

The EL4094 is fairly tolerant of power-supply bypassing, but best multiplier performance is obtained with closely connected 0.1 μF ceramic capacitors. The leaded chip capacitors are good, but neither additional tantalums nor chip components are necessary. The signal inputs can oscillate locally when connected to long lines or unterminated cables.

Power Dissipation

Peak die temperature must not exceed 150°C. At this temperature, the epoxy begins to soften and becomes unstable, chemically and mechanically. This allows 75°C internal temperature rise for a 75°C ambient. The EL4094 in the 8-pin PDIP package has a thermal resistance of 87°/W, and can thus dissipate 862 mW at a 75°C ambient temperature. The device draws 17 mA maximum supply current, only 510 mW at $\pm 15\text{V}$ supplies, and the circuit has no dissipation problems in this package.

The SO-8 surface-mount package has a 153°/W thermal resistance with the EL4094, and only 490 mW can be dissipated at 75°C ambient tem-

perature. The EL4094 thus cannot be operated with $\pm 15\text{V}$ supplies at 75°C in the surface-mount package; the supplies should be reduced to $\pm 5\text{V}$ to $\pm 12\text{V}$ levels, especially if extra dissipation occurs when driving a load.

The EL4094 as a Level Adjust

A common use for gain controls is as an input signal leveller—a circuit that scales too-large or too-small signals to a standard amplitude. A typical situation would be to scale a variable video input by +6 dB to -6 dB to obtain a standard amplitude. The EL4094 cannot provide more than 0 dB gain, but it can span the range of 0 dB to -12 dB with another amplifier gaining the output up by 6 dB. The simplest way to obtain the range is to simply ground the B input and vary the gain of the signal applied to the A input. The disadvantage of this approach is that linearity degrades at low gains. By connecting the signal to the A input of the EL4094 and the signal attenuated by 12 dB to the B input, the gain control offers the highest linearity possible at 0 dB and -12 dB extremes, and good performance between. The circuit is shown on the following page.

The EL4095 can be used to provide the required gains without the extra amplifier. In practice, the gain control is adjusted to set a standard video level regardless of the input level. The EL4583 sync-separator has a recovered amplitude output that can be used to servo the gain control voltage. Here is the curve of differential gain and phase distortion for varying inputs, with the output set to standard video level:

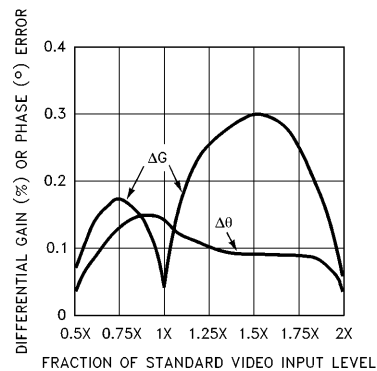

Differential Gain and Phase of Linearized Level Control

4094-14

EL4094C

Video Gain Control/Fader

Applications Information — Contd.
 The differential gain error is kept to 0.3% and the differential phase to 0.15° or better over the entire input range.

The EL4094 as an Adjustable Filter

Equalizers are used to adjust the delay or frequency response of systems. A typical use is to compensate for the high-frequency loss of a cable system ahead of the cable so as to create a flat response at the far end. A generalized scheme with the EL4094 is shown below.

For an adjustable preemphasis filter, for instance, filter A might be an all-pass filter to compensate for the delay of filter B, a peaking filter. Fading the gain from A to B provides a variable amount of peaking, but constant delay.

The EL4094 as a Phase Modulator

To make a phase modulator, filter A might be a leading-phase network, and filter B a lagging network. The wide bandwidth of the gain-control input allows wideband phase modulation of the carrier applied to the main input. Of course, the carrier and gain inputs must not be digital but be reasonably clean sinewaves for the modulation to be accurate.

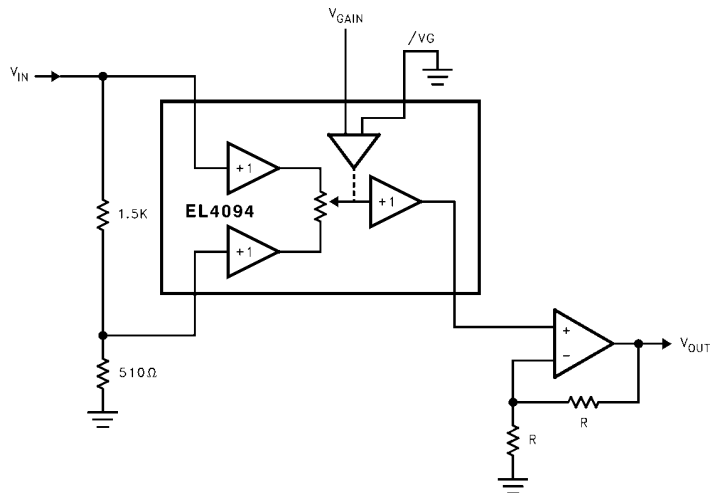

+ 6 dB to - 6 dB Linearized Level Control

4094-13

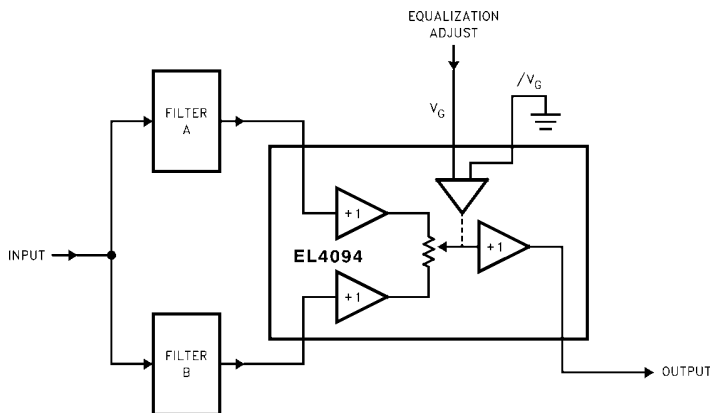

General Adjustable Equalizer

4094-15

EL4094C

Video Gain Control/Fader

EL4094C Macromodel

This macromodel is offered to allow simulation of general EL4094 behavior. We have included these characteristics:

Small-signal frequency response
 Output loading effects
 Input impedance
 Off-channel feedthrough
 Output impedance over frequency

Signal path DC distortions
 V_{GAIN} I-V characteristics
 V_{GAIN} overdrive recovery delay
 100% gain error

These will give a good range of results for various operating conditions, but the macromodel does not behave identically as the circuit in these areas:

Temperature effects
 Signal overload effects
 Signal and V_G operating range
 Current-limit
 Video and high-frequency distortions
 Supply voltage effects
 Slewrate limitations
 Noise
 Power supply interactions

The macromodel's netlist is based on the Pspice simulator (copyrighted by the Microsim Company). Other simulators may not support the POLY function, which is used to implement multiplication as well as square-law nonlinearities.

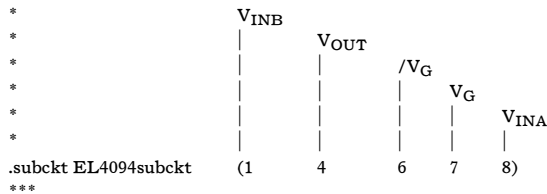

.subckt EL4094subckt

```

ROL 810 0 290k
Ccomp 810 0 3.5p
G1 10 0 810 0 -10
ROUT 10 0 0.1
LOUT 10 4 350.200n
RLOUT 10 4 80
r1 10 910 10
c1 910 911 300p
r2 911 0 90
***
*** Input channel A
***
RINA 22 910 16k
ra 11 0 1k
Cfeedthrougha 23 8 130p
Rfeedthrougha 8 22 1.0
Ela 23 22 1 0 1.0
Rspice3 23 22 1E12
G1a 11 0 POLY(1) (22, 910) 0.0 0.001 -3E-6
G2a 810 0 POLY(2) (11,0) (13, 0) 0.0 0.0 0.0 0.0 0.001
***
*** Input channel B
***
RINB 25 910 16k
rb 20 0 1k
Cfeedthroughb 24 1 130p
Rfeedthroughb 1 25 1.0
E1b 24 25 8 0 1.0
Rspice4 24 25 1E12
G1b 20 0 POLY(1) (25, 910) 0.0 0.001 -3E-6
G2b 810 0 POLY(2) (20,0) (19, 0) 0.0 0.0 0.0 0.0 0.001
***
*** Gain control
***
Rspice1 13 0 1E12
Rspice2 18 0 1E12
R10 14 0 1E7
C10 14 0 8E-16
D1 14 15 Dclamp
D2 16 14 Dclamp
.model Dclamp D (TT=200n)
V1 15 0 4999.3
V2 0 16 4999.3
V3 13 17 0.5
V4 19 18 0.5
G10 14 0 7 6 -0.001
G11 7 6 14 0 -2E-8
E10 17 0 14 0 1E-4
E11 18 0 14 0 -1E-4
***
.ends
*****
  
```

EL4094C

Video Gain Control/Fader

EL4094C Macromodel — Contd.

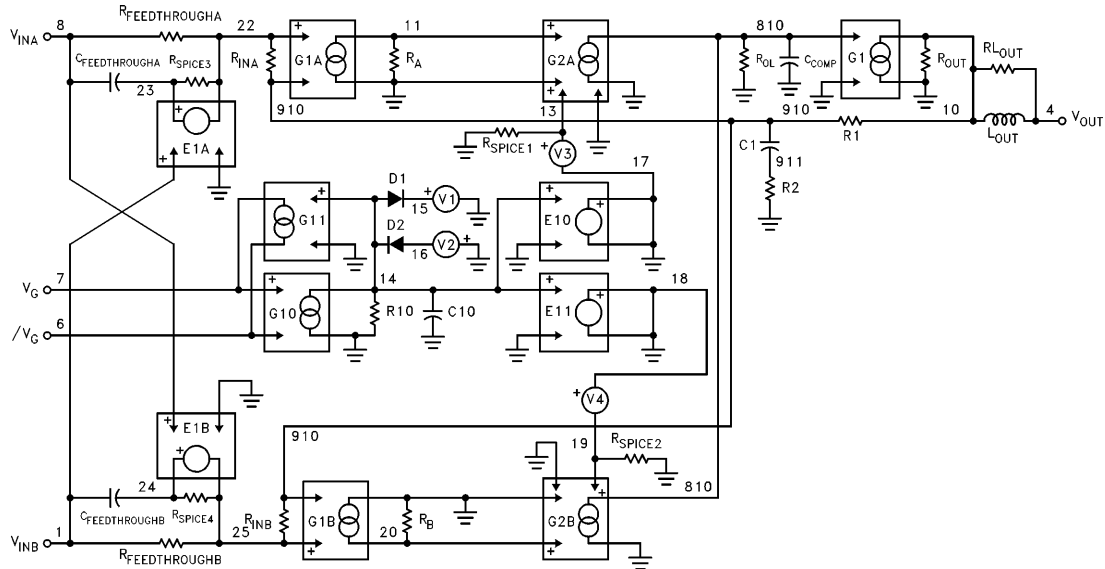

EL4094 Macromodel Schematic

4094-16

General Disclaimer

Specifications contained in this data sheet are in effect as of the publication date shown. Elantec, Inc. reserves the right to make changes in the circuitry or specifications contained herein at any time without notice. Elantec, Inc. assumes no responsibility for the use of any circuits described herein and makes no representations that they are free from patent infringement.

élantec
HIGH PERFORMANCE ANALOG INTEGRATED CIRCUITS

Elantec, Inc.
1996 Tarob Court
Milpitas, CA 95035
Telephone: (408) 945-1323
(800) 333-6314
Fax: (408) 945-9305
European Office: 44-71-482-4596

WARNING — Life Support Policy

Elantec, Inc. products are not authorized for and should not be used within Life Support Systems without the specific written consent of Elantec, Inc. Life Support systems are equipment intended to support or sustain life and whose failure to perform when properly used in accordance with instructions provided can be reasonably expected to result in significant personal injury or death. Users contemplating application of Elantec, Inc. products in Life Support Systems are requested to contact Elantec, Inc. factory headquarters to establish suitable terms & conditions for these applications. Elantec, Inc.'s warranty is limited to replacement of defective components and does not cover injury to persons or property or other consequential damages.