

PLEASE CHECK WWW.MOLEX.COM FOR LATEST PART INFORMATION

Part Number: **5601230400**
Status: **Active**
Overview: DuraClik™ Connector System
Description: DuraClik ISL Wire-to-Board Receptacle Housing, Single Row, White, 4 Circuits

Documents:

3D Model	Application Specification AS-560123-001-001 (PDF)
Drawing (PDF)	Packaging Specification 5601230900-PK (PDF)
Product Specification 5601230900- PS (PDF)	Packaging Specification PK-560123-001-002 (PDF)
Product Specification PS-560123-002-001 (PDF)	RoHS Certificate of Compliance (PDF)
Product Specification PS-560123-003-001 (PDF)	

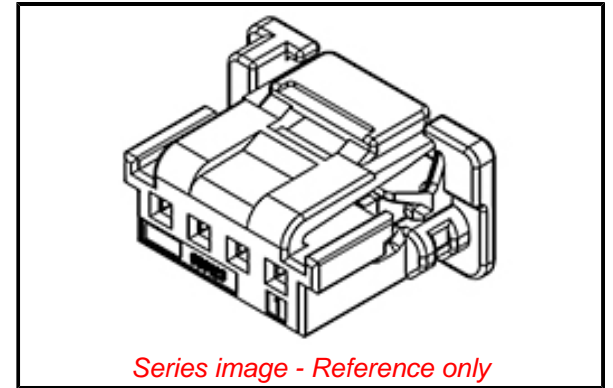

General

Product Family	Crimp Housings
Series	560123
Application	Signal, Wire-to-Board
Overview	<u>DuraClik™ Connector System</u>
Product Name	DuraClik
UPC	887191705538

Physical

Circuits (maximum)	4
Color - Resin	White
Gender	Receptacle
Glow-Wire Compliant	No
Keying to Mating Part	None
Lock to Mating Part	Yes
Material - Resin	PBT
Net Weight	0.274/g
Number of Rows	1
Packaging Type	Tray
Panel Mount	No
Pitch - Mating Interface	2.00mm
Polarized to Mating Part	Yes
Stackable	No
Temperature Range - Operating	-40°C to +125°C

Solder Process Data

Lead-freeProcess Capability	N/A
-----------------------------	-----

Material Info

Reference - Drawing Numbers

Application Specification	AS-560123-001-001
Packaging Specification	5601230900-_PK, PK-560123-001-002
Product Specification	5601230900-_PS, PS-560123-002-001, PS-560123-003-001
Sales Drawing	SD-560123-002

EU ELV

Compliant

EU RoHS

Compliant

REACH SVHC

Not Contained Per -
ED/30/2017 (7 July
2017)

Halogen-Free

Status

Not Low-Halogen

Need more information on product environmental compliance?

Email productcompliance@molex.com
Please visit the [Contact Us](#) section for any non-product compliance questions.

China ROHS

ELV

RoHS Phthalates

Green Image

Compliant

Not Contained

Search Parts in this Series

[560123 Series](#)

Mates With

DuraClik Right-Angle Header [502352](#)
DuraClik Vertical Header [560020](#)

Use With

DuraClik ISL Terminal [560124](#)
DuraClik ISL Retainer [560125](#)