

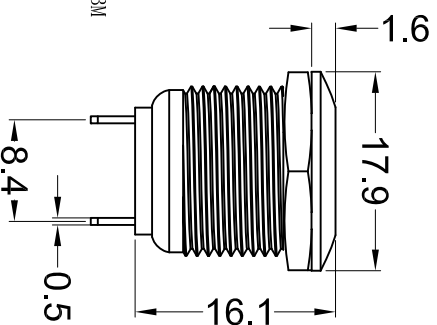



外壳镗雕D-SWITCH,  
背面相对位置镗雕PBM



- 备注:
1. 外壳镗雕A3;
  2. 拧螺母, 配垫圈。

Nut Torque:5~14Nm  
 Protection Grade:IP65,IK08  
 Shell:Brass,Ni Plating  
 Base:PBT+15%GF  
 Lamp Type:LED  
 Forward current:20mA Max  
 Lamp Life:50000H  
 Beads Color:Red,Green And Yellow  
 Lamp voltage:3V DC  
 Operating Temperature:-20°C~80°C  
 Relative Air Humidity:45%~85%  
 Safety Approval:   

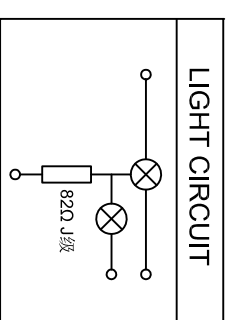
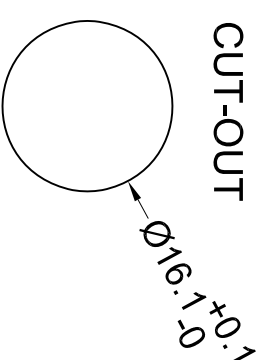
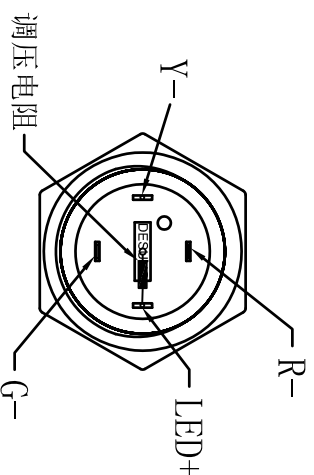

**D-SWITCH**  
 东莞市德祿电子有限公司  
 D-SWITCH ELECTRONICS CO.,LTD

公差 TOLERANCES .X $\pm$ 0.5 .XX $\pm$ 0.3 角度 ANGLE  $\pm$ 1° 单位 DIMENSION UNIT mm.

版本 VER	变更说明 CHANGE DESCRIPTION	日期 DATE	ECON NO.	版本 VERSION	核准 APPROVED BY	比例尺 SCALE	核对 CHECKED BY	日期 DATE	绘图 DRAWN BY	品名 TITLE	图号 DRAWING NO
				A0		1:1		2022.03.10	孙成	PBM-16I12-FS-RGY2-R3-B8S-A3-0004	1030453