

AEO40x48 / ALO40x48 Single Output 8th Brick: Baseplate or Open-Frame Module

The AEO40x48 / ALO40x48 series is Astec's High Current 8th Brick industry standard offering. Operating from an input voltage range of 36V to 75V, the series provides 7 configured outputs starting from 1.2V all the way up to 12V. It delivers up to 40A max current for 1.8V and lower at impressive levels of efficiency. It provides tight regulation and exhibits clean and monotonic output start up characteristics. The AEO_ALO series comes with industry standard features such as Input UVLO; non-latching OCP, OVP and OTP; Output Trim; Differential Remote Sense pins. Both baseplate (AEO) and open frame (ALO) construction are available as well as TH or SMT termination. With its wide operating temperature range of -40°C to 85°C ambient, the converters are deployable into almost any environment.



Special Features

- Industry Standard 8th Brick Footprint
- Baseplate or Open frame construction
- Low Ripple and Noise
- Regulation to zero load
- High Capacitive Load Start-up
- Fixed Switching Frequency
- Industry standard features: Input UVLO; Enable; non-latching OVP, OCP and OTP; Output Trim, Differential Remote Sense
- Meets Basic Insulation

Environmental Specifications

- -40°C to 85°C Operating Temperature
- -55°C to 125°C Storage Temperature
- MTBF > 1 million hours

Electrical Parameters

Input

Input Range 36-75 VDC
 Input Surge 100V / 100ms

Control

Enable TTL compatible
 (Positive or Negative Logic Enable Options)

Output

Load Current Up to 40A max (V_O £ 1.8V)
 Line/Load Regulation < 1% V_O
 Ripple and Noise 40mV_{P-P} typical
 Output Voltage
 Adjust Range ±10% V_O
 Transient Response 2% Typical deviation
 50% to 75% Load Change
 20ms settling time (Typ)
 Remote Sense +10%V_O
 Over Current 120% max
 Protection
 Over Voltage 130% max
 Protection
 Over Temperature 110 °C
 Protection

Safety

UL + cUL 60950, Recognized
 EN60950 through TUV-PS



Technical Reference Notes
AEO_ALO40/35/30/20/10x48 Series
 (Single Output 8th Brick)



Electrical Specifications

ABSOLUTE MAXIMUM RATINGS

Stresses in excess of the absolute maximum ratings can cause permanent damage to the converter. Functional operation of the device is converter is not implied at these or any other conditions in excess of those given in the operational section of the specs. Exposure to absolute maximum ratings for extended period can adversely affect device reliability.

Parameter	Device	Symbol	Min	Typical	Max	Unit
Input Voltage Continuous Transient (100ms)	All	V_{in} $V_{in_{trans}}$	-0.3 -	- -	75 100	Vdc
I/O Isolation Input-to-Output	All	-	1500	-	-	Vdc
Operating Temperature ¹	All	T_A	-40	-	85	°C
Storage Temperature	All	T_{STG}	-55	-	125	°C
Operating Humidity	All	-	10	-	85	%
Max Voltage at Enable Pin	All	-	-0.6	-	25	Vdc
Max Output Power	B (12V0) A (5V0) F (3V3) G (2V5) Y (1V8) M (1V5) K (1V2)	$P_{O,MAX}$	- - - - - - -	- - - - - - -	120.0 100.0 99.0 88.0 72.0 60.0 48.0	W

INPUT SPECIFICATION

	Device	Symbol	Min	Typical	Max	Unit
Operating Input Voltage Range	All	V_{IN}	36	48	75	Vdc
Input Under-Voltage Lock-out T_ON Threshold T_OFF Threshold	All		33 31	34 32	36 34	Vdc
Max Input Current ²	B (12V0) A (5V0) F (3V3) G (2V5) Y (1V8) M (1V5) K (1V2)	$I_{in_{max}}$	- - - - - - -	- - - - - - -	4.2 3.5 3.5 3.3 3.0 2.7 2.5	A
Standing Loss	B (12V0) A (5V0) F (3V3) G (2V5) Y (1V8) M (1V5) K (1V2)		- - - - - - -	- - - - - - -	4.0 4.0 4.0 4.0 4.5 3.5 3.0	W
Input Ripple Current ³	All	I_{ri}	-	10	30	mAp-p
Inrush Current	All	i^2t	-	0.01	-	A ² s



Technical Reference Notes
AEO_ALO40/35/30/20/10x48 Series
 (Single Output 8th Brick)



Electrical Specifications (continued)

OUTPUT SPECIFICATIONS

Parameter	Device	Symbol	Min	Typical	Max	Unit
Output Voltage Set point $V_{IN} = V_{IN,MIN}$ to $V_{IN,MAX}$ $I_O = I_{O,MAX}$	B (12V0) A (5V0) F (3V3) G (2V5) Y (1V8) M (1V5) K (1V2)	$V_{O,SET}$	11.80 4.90 3.25 2.45 1.76 1.47 1.17	12.00 5.00 3.30 2.50 1.80 1.50 1.20	12.20 5.10 3.35 2.55 1.84 1.53 1.22	Vdc
Output Regulation Line $V_{IN} = V_{IN,MIN}$ to $V_{IN,MAX}$ Load $V_{IN} = V_{IN,NOM}$ $I_O = I_{O,MIN}$ to $I_{O,MAX}$ Temp $V_{IN} = V_{IN,NOM}$; $I_O = I_{O,MAX}$	All	-	-	0.1	0.2	%
Output Ripple and Noise ⁴ Peak-to-Peak $I_O = I_{O,MAX}$; $V_{IN} = V_{IN,NOM}$; BWL = 20 MHz; $T_A = 25$ °C	B (12V0) A (5V0) F (3V3) G (2V5) Y (1V8) M (1V5) K (1V2))	-	-	50 40 40 20 40 30 20	120 90 75 75 60 60 60	mVp-p
Output Current ⁵	B (12V0) A (5V0) F (3V3) G (2V5) Y (1V8) M (1V5) K (1V2)	I_O	0 0 0 0 0 0 0	- - - - - - -	10 20 30 35 40 40 40	A
Output Current-limit Inception $V_O = 90\% V_{O,NOM}$; $T_A = 25$ °C $V_{IN} = V_{IN,NOM}$ Non-latching / auto-recovery	B (12V0) A (5V0) F (3V3) G (2V5) Y (1V8) M (1V5) K (1V2)	$I_{O,OC}$	11.5 24.0 33.0 41.0 44.0 44.0 44.0	- - - - - - -	17.0 32.0 41.5 49.0 78.0 78.0 78.0	A
External Load Capacitance $I_O = I_{O,MAX}$, resistive load ESR	All B (12V0) A (5V0) F (3V3)	C_{EXT}	- - - 4	- - - -	20,000 1,500 10,000 10,000	μ F m Ω



Technical Reference Notes
AEO_ALO40/35/30/20/10x48 Series
 (Single Output 8th Brick)



Electrical Specifications (continued)

OUTPUT SPECIFICATIONS

Parameter	Device	Symbol	Min	Typical	Max	Unit	
Efficiency $V_{IN} = V_{IN,NOM}; I_O = I_{O,MAX}$ $T_A = 25\text{ }^\circ\text{C};$	B (12V)	η	91.0	92.0	93.0	%	
	A (5.0V)	η	92.0	93.0	94.0		
	F (3.3V)	η	90.0	91.0	93.0		
	G (2.5V)	η	89.0	90.0	92.0		
	Y (1.8V)	η	88.0	89.5	90.5		
	M (1.5V)	η	85.5	88.0	89.5		
	K (1.2V)	η	84.0	86.0	87.5		
Output Over Voltage Protection Non-latching / autorecovery	B (12V)	$V_{O,OV\overline{P}}$	13.80	14.40	15.00	V	
	A (5.0V)		5.80	6.00	6.20		
	F (3.3V)		3.80	4.00	4.30		
	G (2.5V)		2.90	3.00	3.20		
	Y (1.8V)		2.10	2.30	2.50		
	M (1.5V)		1.75	1.85	2.38		
Over Temperature Protection Autorecovery	All		110	-	120	$^\circ\text{C}$	
Input to Output Turn-On Delay $V_{IN} = V_{IN,NOM}, I_O = I_{O,MAX}$	All	-	-	-	17	ms	
	5V, 12V				20		
Enable to Output Turn-On Delay $V_{IN} = V_{IN,NOM}, I_O = I_{O,MAX}$	All	-	-	-	17	ms	
	5V, 12V				20		
Output Voltage Rise Time 10% to 90% of $V_{O,NOM}$ $V_{IN} = V_{IN,NOM}, I_O = I_{O,MAX}$	All	-	-	3.0	9.0	ms	
	5V	-	-	4.0	11.0		
	12V	-	-	9.0	16.0		
Switching Frequency	All	F_{SW}	380	450	520	kHz	
Output Voltage Remote Sensing	All	-	-	-	10	% V_O	
Output Voltage Trim Range ⁶	All		90		110	% V_O	
Output Voltage Overshoot	All	-	-	0	3	% V_O	
Dynamic Response $di/dt = 0.1\text{ A}/\mu\text{s}$							
	Peak Deviation $\Delta I_O = 50\%$ to 75% of $I_{O,max}$	All	-	-	2	5	%
	Settling Time $V_{ref} = V_{O,nom}$	All	-	-	-	250	μs
	Peak Deviation $\Delta I_O = 50\%$ to 25% of $I_{O,max}$	All	-	-	2	5	%
Settling Time $V_{ref} = V_{O,nom}$	All	-	-	-	250	μs	



Technical Reference Notes
AEO_ALO40/35/30/20/10x48 Series
(Single Output 8th Brick)



Electrical Specifications *(continued)*

OUTPUT SPECIFICATIONS

Parameter	Device	Symbol	Min	Typical	Max	Unit
Output Enable ON/OFF Open collector TTL compatible						
Positive Enable: Mod-ON	All	-	2.95	-	20	V
Mod-OFF	All	-	-0.50	-	1.20	V
Negative Enable: Mod-ON	All	-	-0.50	-	1.20	V
Mod-OFF	All	-	2.95	-	20	V

- Note:
1. Derating curves for both openframe and baseplate modules are based on derated component junction temperatures of 120°C or less where applicable.
 2. Module is not internally fused; an external input line fuse is recommended for use (e.g. Littlefuse® 465 Series / 250V min).
 3. Refer to Figure 1 for the input ripple current test measurement setup.
 4. Refer to Fig 2 for the output ripple and noise test measurement setup.
 5. Output derating may apply at elevated ambient temperatures. Please refer to the appropriate derating curves.
 6. Refer to the output trim equations provided (Equation 1 and 2).

SAFETY AGENCY / MATERIAL RATING / ISOLATION

Parameter	Device	Symbol	Min	Typical	Max	Unit
Safety Approval ⁷	All	UL/cUL 60950, 35d Edition – Recognized EN 60950 through TUV				
Material Flammability Rating	All	UL94V-0				
Input to Output Capacitance	All		-	1000	-	pF
Input to output Resistance	All		-	10	-	MOhms
Input to Output Insulation Type	All		-	Basic	-	-

- Note: 7. The 3.3V, 5V and 12V modules have completed required safety approvals.

Electrical Specifications *(continued)*

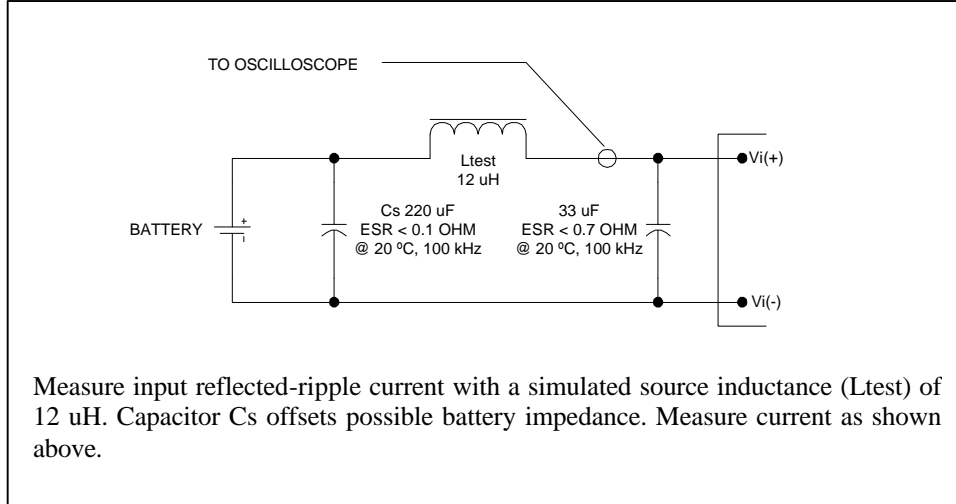

Figure 1. Input Reflected Ripple Current Measurement Setup.

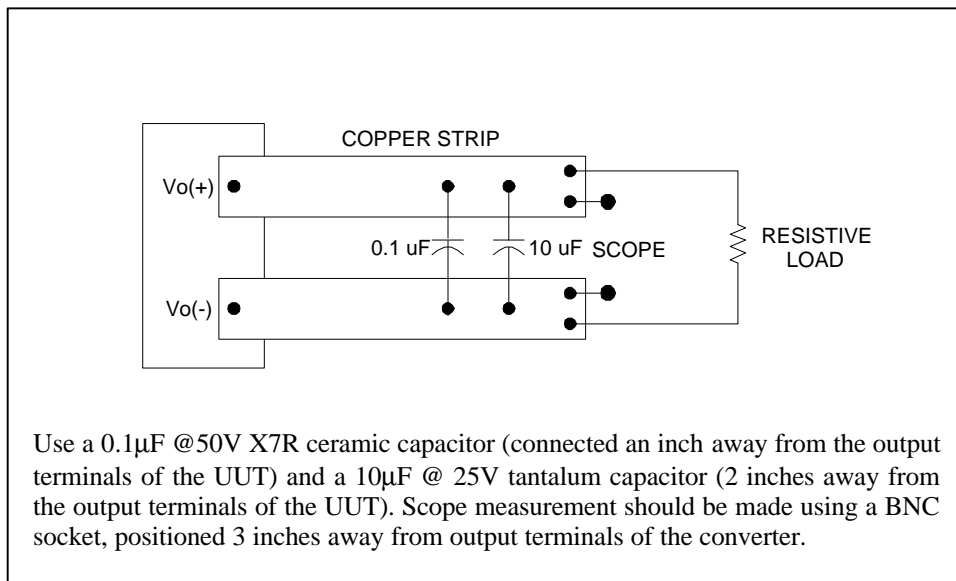

Figure 2. Peak to Peak Output Noise Measurement Setup.

Basic Operation and Features

INPUT UNDER VOLTAGE LOCKOUT

To prevent any instability to the converter, which may affect the end system, the converter have been designed to turn-on once V_{IN} is in the voltage range of 33-36 VDC. Likewise, it has also been programmed to turn-off when V_{IN} drops down to 31-34 VDC.

OUTPUT VOLTAGE ADJUST/TRIM

The converter comes with a TRIM pin (PIN 6), which is used to adjust the output by as much as 90% to 110% of its set point. This is achieved by connecting an external resistor as described below.

To **INCREASE** the output, external R_{adj_up} resistor should be connected between TRIM PIN (Pin6) and +SENSE PIN (Pin 7). Please refer to Equation (1) for the required external resistance and output adjust relationship.

Equation (1a): 1.5V to 12V

$$R_{adj_up} = \left[\frac{5.1 \times V_{o_set} \times (100 + \Delta\%)}{1.225 \times \Delta\%} - \frac{510}{\Delta\%} - 10.2 \right] \text{ K } \Omega$$

Equation (1b): 1.2V

$$R_{adj_up} = \left[\frac{5.1 \times V_{o_set} \times (100 + \Delta\%)}{0.6 \times \Delta\%} - \frac{510}{\Delta\%} - 10.2 \right] \text{ K } \Omega$$

To **DECREASE** the output, external R_{adj_down} resistor should be connected between TRIM pin (Pin 6) and -SENSE PIN (Pin 5). Please refer to Equation (2) for the required external resistance and output adjust relationship.

Equation (2):

$$R_{adj_down} = \left(\frac{510}{\Delta\%} - 10.2 \right) \text{ k}\Omega$$

Where: $\Delta\%$ = percent change in output voltage

OUTPUT ENABLE

The converter comes with an Enable pin (PIN 2), which is primarily used to turn ON/OFF the converter. Both a Positive (no “N” suffix required) and a Negative (suffix “N” required) Enable Logic options are being offered. Please refer to Table 2 for the Part Numbering Scheme.

For Positive Enable, the converter is turned on when the Enable pin is at logic HIGH or left open. The unit turns off when the Enable pin is at logic LOW or directly connected to $-V_{IN}$. On the other hand, the Negative Enable version turns unit on when the Enable pin is at logic LOW or directly connected to $-V_{IN}$. The unit turns off when the Enable pin is at Logic HIGH.

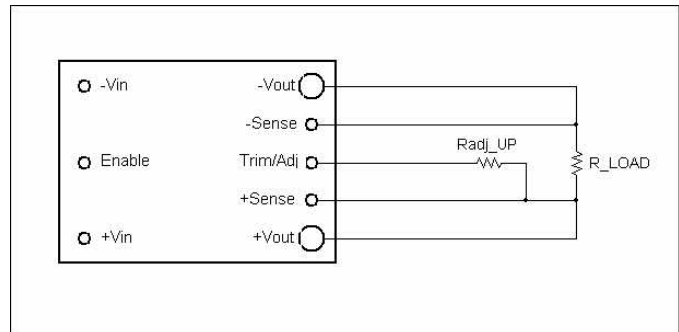

Figure 3. External resistor configuration to increase the o/p.

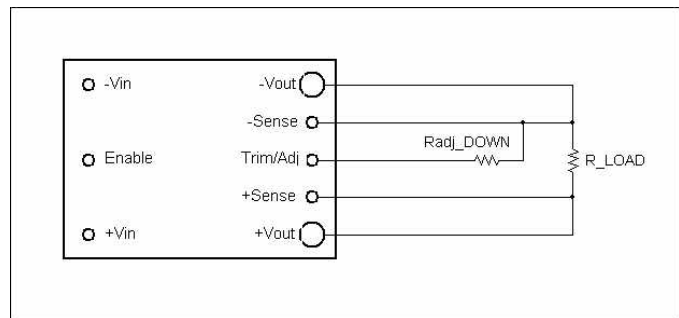

Figure 4. External resistor configuration to decrease the o/p.



Technical Reference Notes
AEO_ALO40/35/30/20/10x48 Series
(Single Output 8th Brick)



Basic Operation and Features *(continued)*

OUTPUT OVER VOLTAGE PROTECTION (OVP)

The Over Voltage Protection circuit is non-latching - auto recovery mode. The output of the converter is terminated under an OVP fault condition ($V_o > \text{OVP threshold}$). The converter will attempt to restart until the fault is removed. There is a 100ms lockout period between restart attempts.

OVER CURRENT PROTECTION (OCP)

The Over Current Protection is non-latching - auto recovery mode. The converter shuts down once the output current reaches the OCP range. The converter will attempt to restart until the fault is removed. There is a 100ms lockout period between restart attempts.

OVER TEMPERATURE PROTECTION (OTP)

The Over Temperature Protection circuit will shutdown the converter once the average PCB temperature (See Figure 90B for OTP reference sense point) reaches the OTP range. This feature prevents the unit from overheating and consequently going into thermal runaway, which may further damage the converter and the end system. Such overheating may be an effect of operation outside the given power thermal derating conditions. Restart is possible once the temperature of the sensed location drops to less than 110°C.

REMOTE SENSE

The remote sense pins can be used to compensate for any voltage drops (per indicated max limits) that may occur along the connection between the output pins to the load. Pin 7 (+Sense) and Pin 5 (-Sense) should be connected to Pin 8 (+Vout) and Pin 4 (Return) respectively at the point where regulation is desired. The combination of remote sense and trim adjust cannot exceed 110% of V_o . When output voltage is trimmed up (through remote sensing and/or trim pin), output current must be derated and maximum output power must not be exceeded.

Performance Curves

12V @ 10A

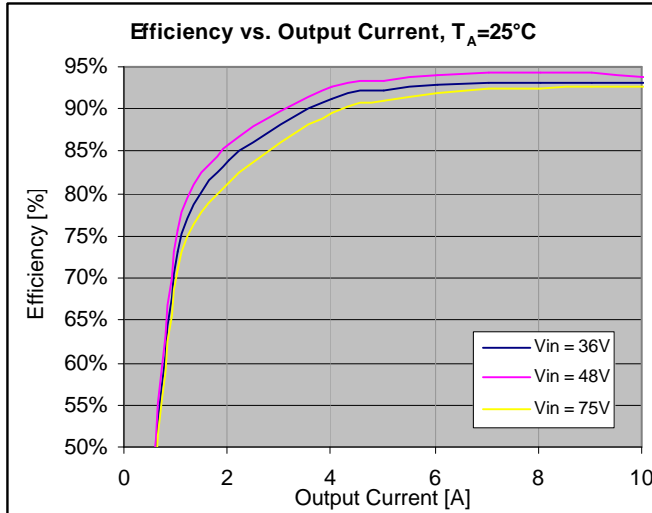

Figure 5. Efficiency vs. Load Current at minimum, nom and high line, $T_A = 25^\circ\text{C}$.

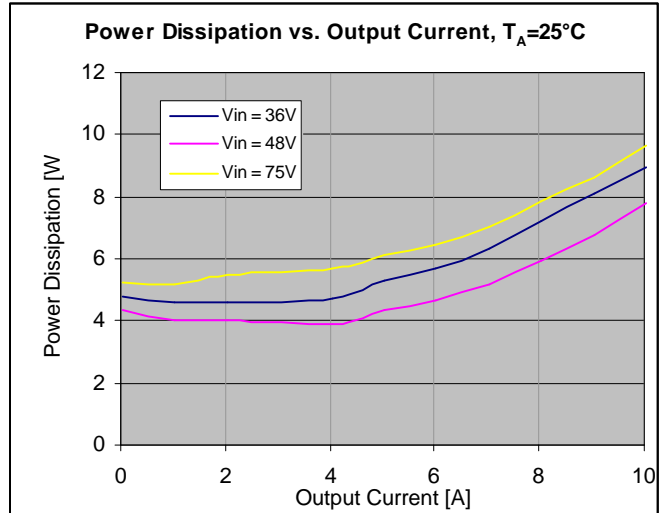

Figure 6. Power Dissipation vs. Load Current at min, nominal and high line, $T_A = 25^\circ\text{C}$.

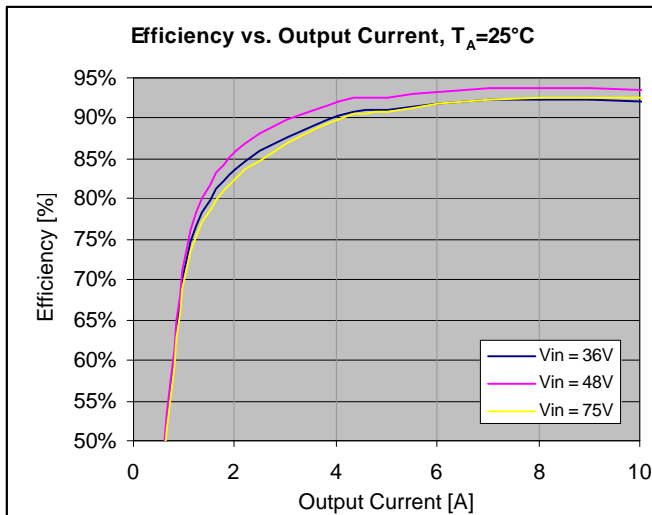

Figure 7. Efficiency vs. Load Current at minimum, nom and high line, $T_A = 85^\circ\text{C}$.

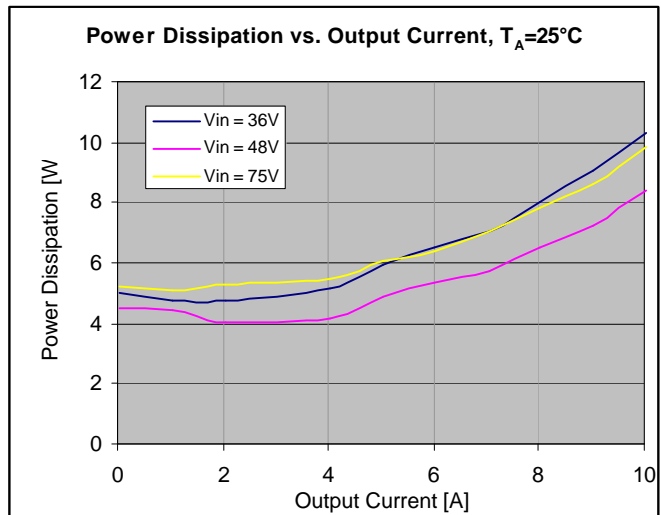

Figure 8. Power Dissipation vs. Load Current at min, nominal and high line, $T_A = 85^\circ\text{C}$.

Performance Curves

12V @ 10A (continued)

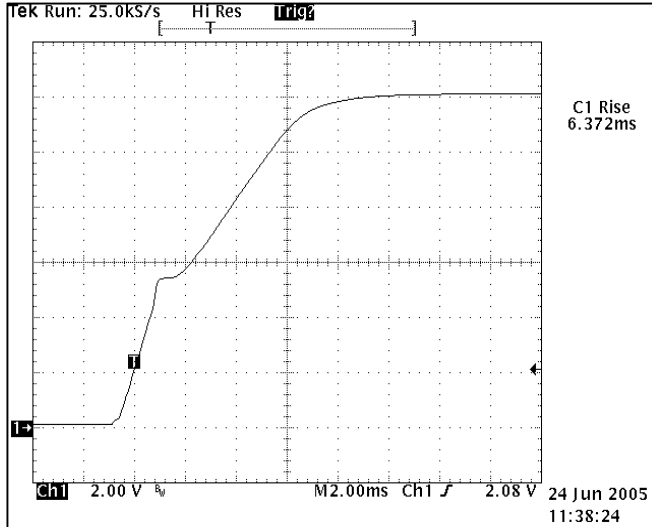

Figure 9. 12V output startup characteristic at $V_{IN} = 48\text{Vdc}$, $I_O = \text{Full Load}$, $T_A = 25\text{ }^\circ\text{C}$, $C_O = 0$.

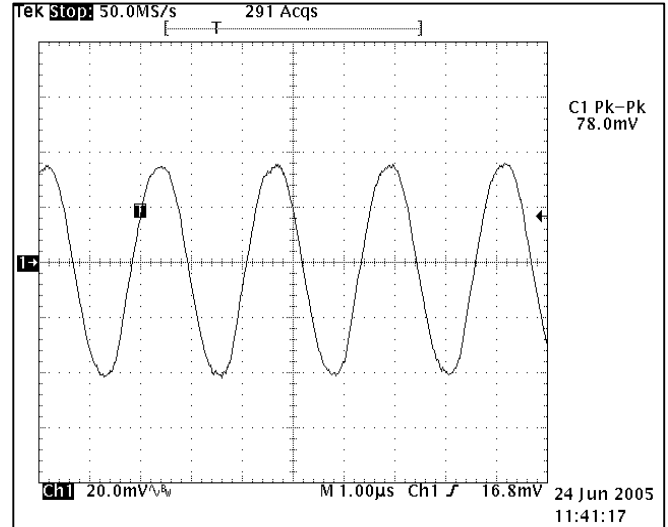

Figure 10. 12V output ripple at $V_{IN} = 48\text{Vdc}$, $I_O = \text{Full Load}$, $T_A = 25\text{ }^\circ\text{C}$.

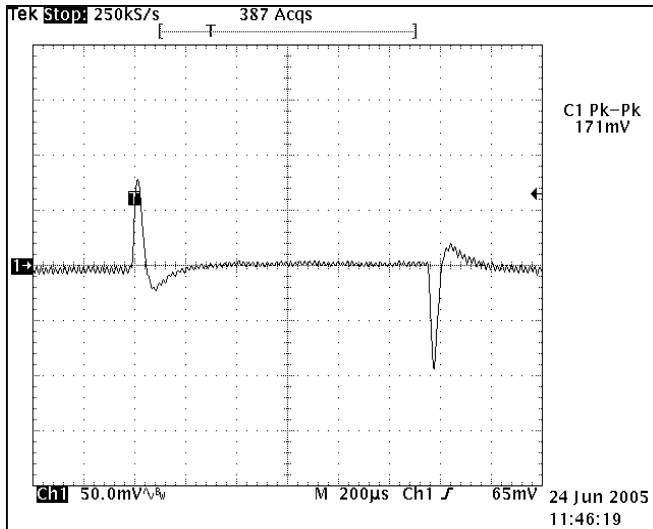

Figure 11. 12V output transient response 25% to 50% step change at $V_{IN} = 48\text{Vdc}$, $T_A = 25\text{ }^\circ\text{C}$, $C_O = 0$.

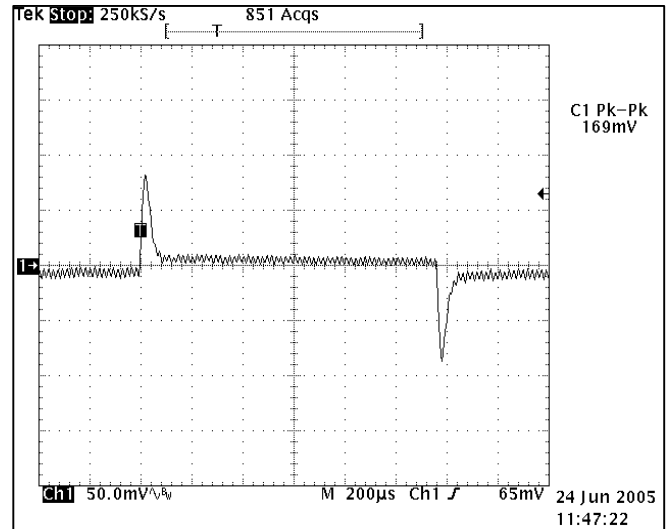

Figure 12. 12V output transient response 50% to 75% step change at $V_{IN} = 48\text{Vdc}$, $T_A = 25\text{ }^\circ\text{C}$, $C_O = 0$.

Performance Curves

12V @ 10A (continued)

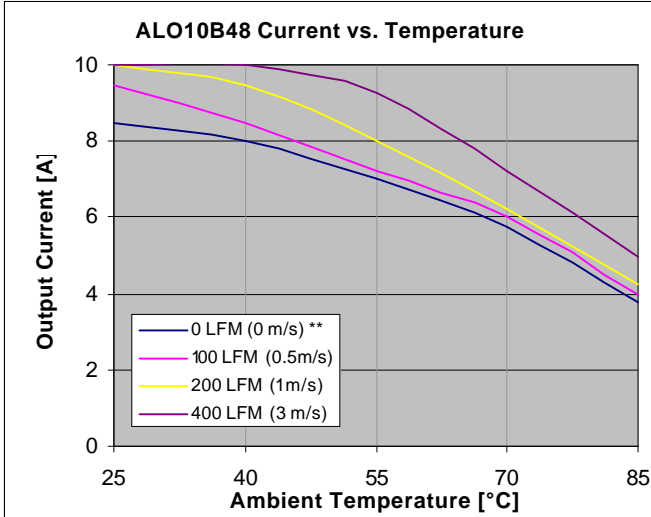

Figure 13. Output Current vs. Temperature for open frame version at $V_{IN} = 48Vdc$ ($T_J \leq 120^\circ C$).

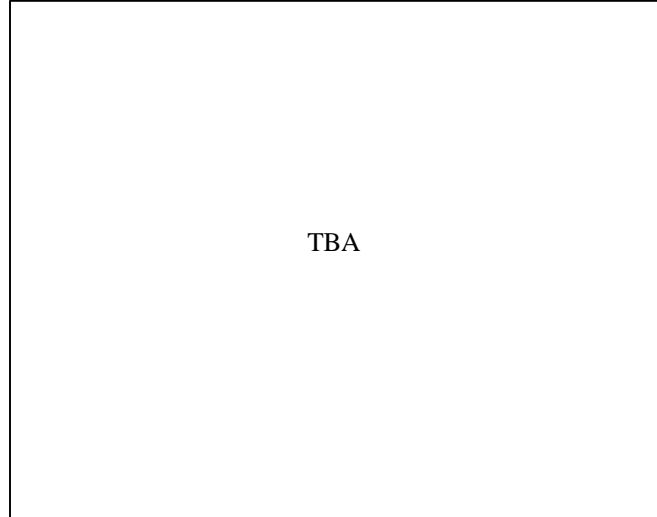

Figure 14. Output Current vs. Temperature for baseplate version at $V_{IN} = 48Vdc$ ($T_J \leq 120^\circ C$).

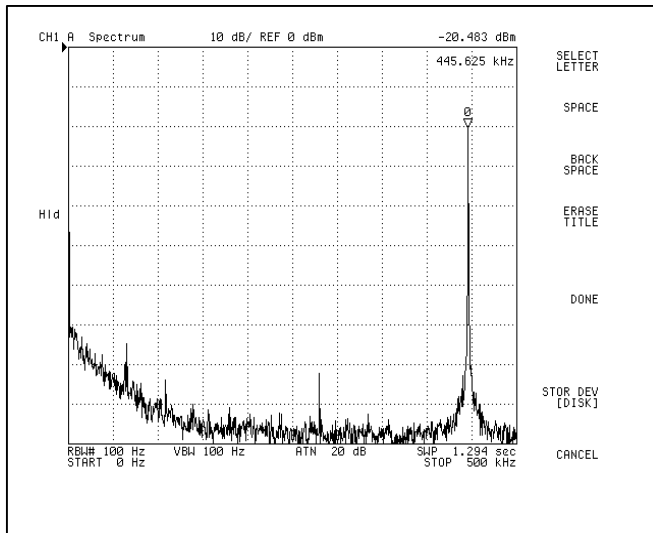

Figure 15. Typical output frequency spectrum (0 – 500kHz) at $V_{IN} = 48Vdc$, $I_O = 50\%$ Load, $C_{OUT} = 0$.

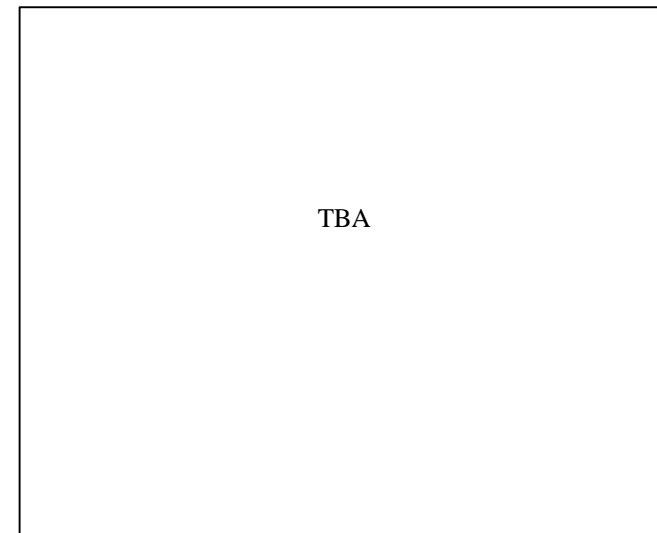

Figure 16. 12V Conducted EMI per Filter defined in Fig 89. $V_{IN} = 48Vdc$, $I_O = 50\%$ Resistive Load, $T_A = 25^\circ C$.

Performance Curves

5V @ 20A (continued)

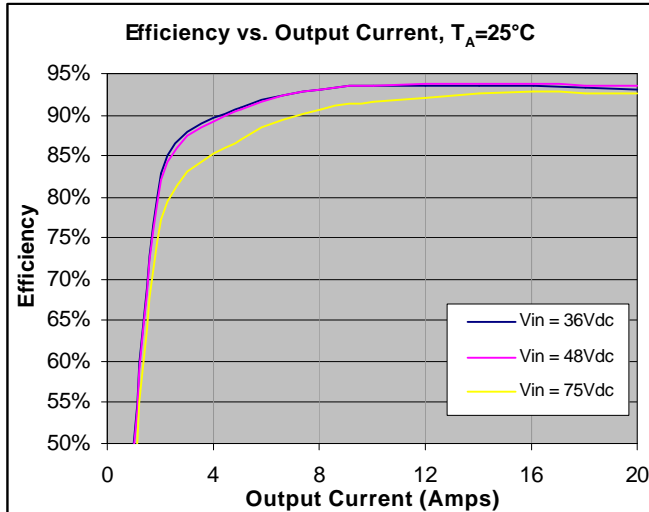

Figure 17. Efficiency vs. Load Current at minimum, nom and high line, $T_A = 25^\circ\text{C}$.

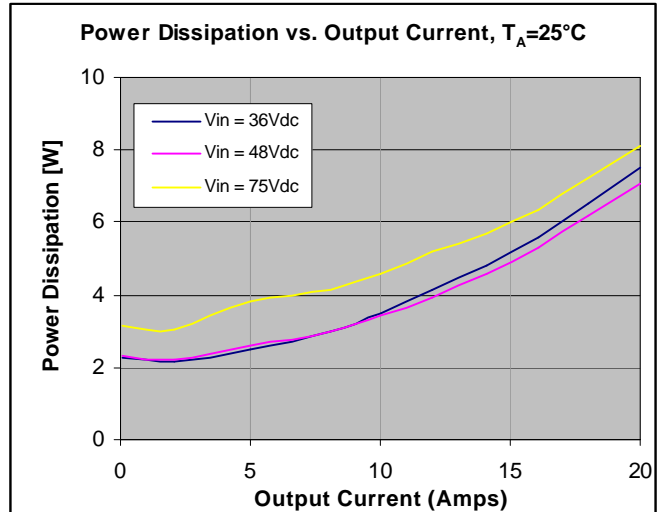

Figure 18. Power Dissipation vs. Load Current at min, nominal and high line, $T_A = 25^\circ\text{C}$.

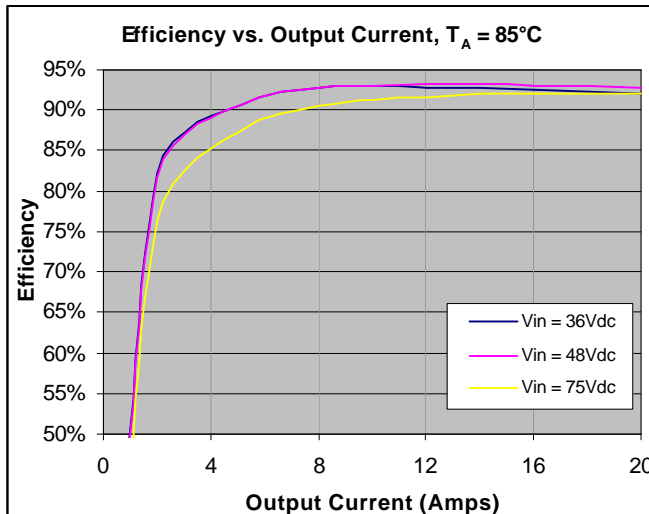

Figure 19. Efficiency vs. Load Current at minimum, nom and high line, $T_A = 85^\circ\text{C}$.

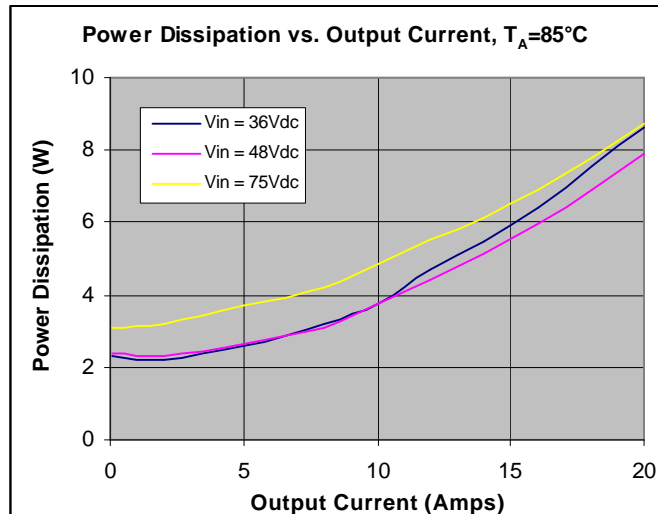
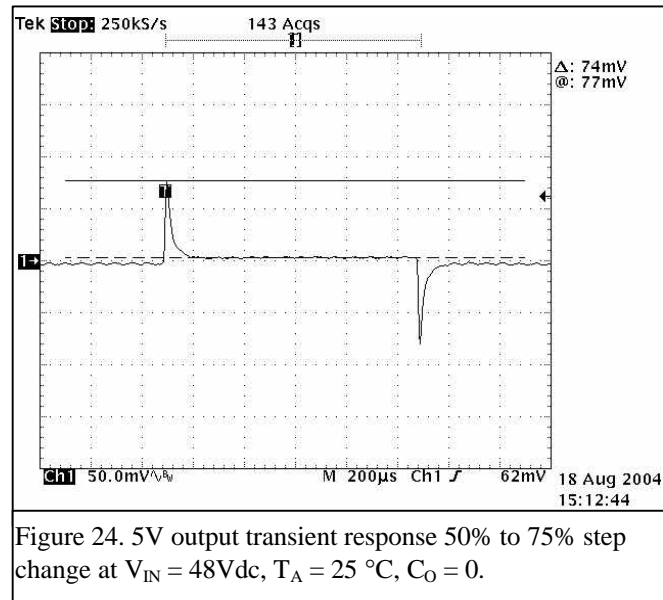
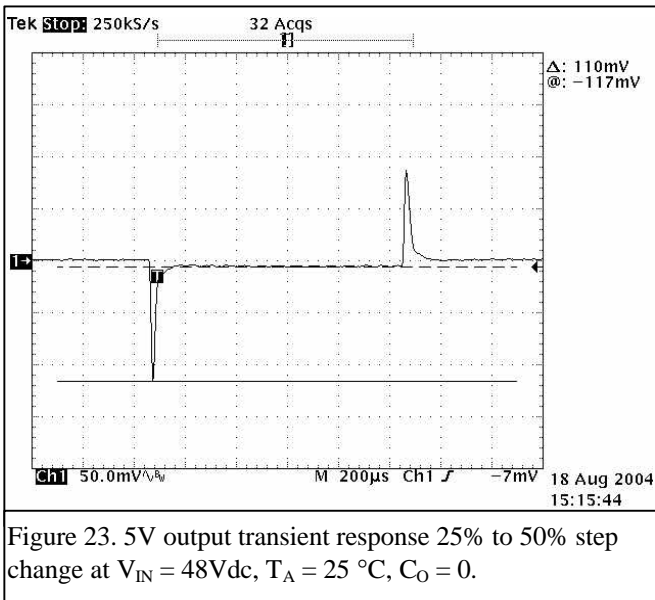
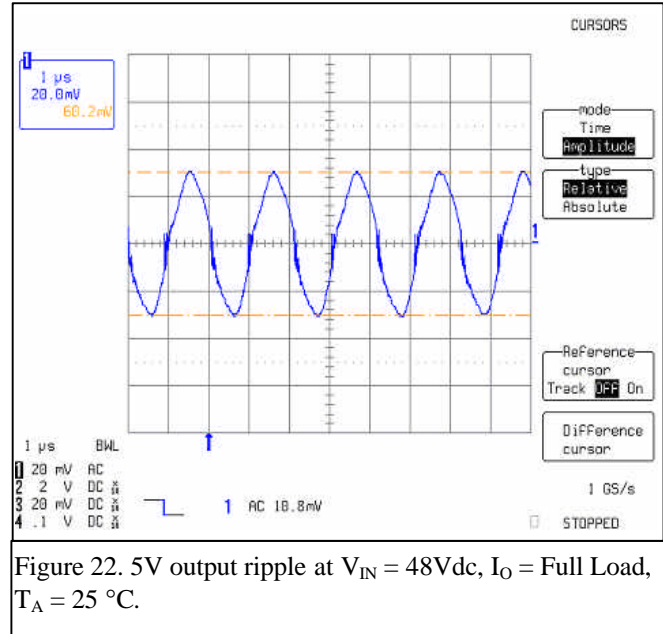
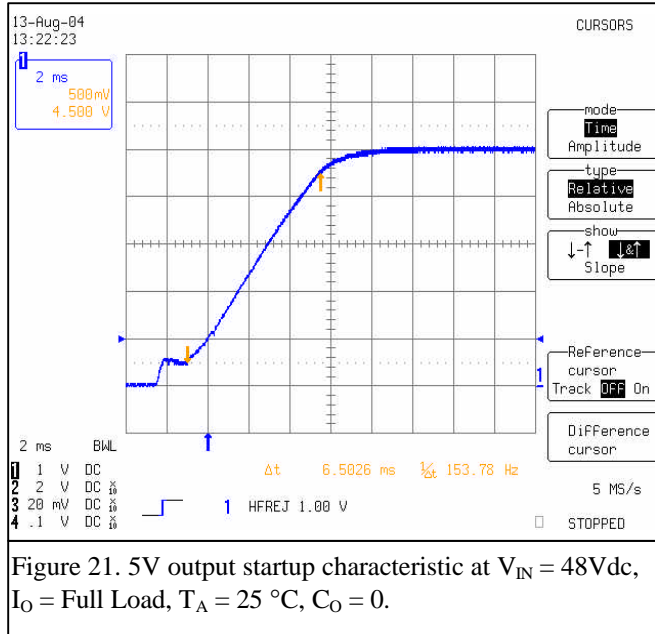

Figure 20. Power Dissipation vs. Load Current at minimum, nominal and high line, $T_A = 85^\circ\text{C}$.

Performance Curves

5V @ 20A (continued)



Performance Curves

5V @ 20A (continued)

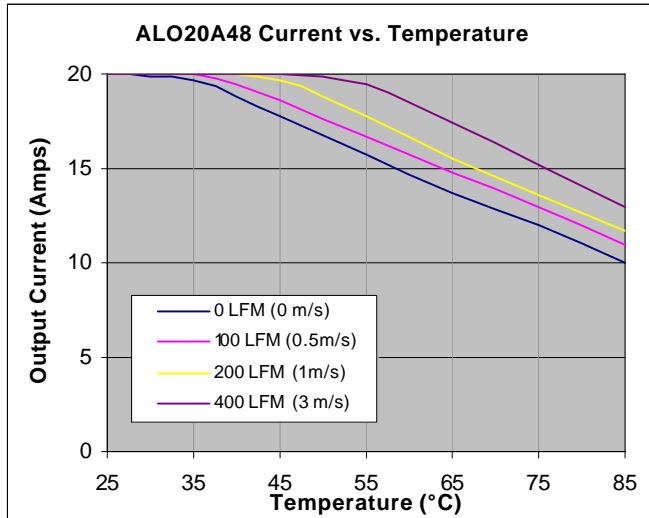

Figure 25. Output Current vs. Temperature for open frame version at $V_{IN} = 48Vdc$ ($T_J \leq 120^\circ C$).

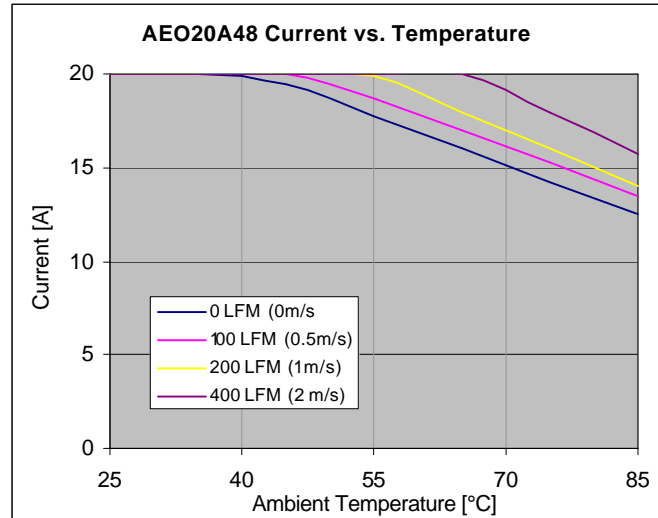

Figure 26. Output Current vs. Temperature for baseplate version at $V_{IN} = 48Vdc$ ($T_J \leq 120^\circ C$).

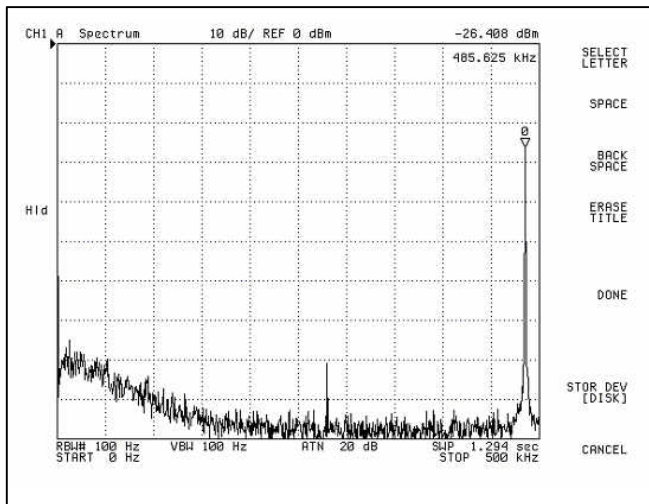

Figure 27. Typical output frequency spectrum (0 – 500kHz) at $V_{IN} = 48Vdc$, $I_O = 50\%$ Load, $C_{OUT} = 0$.

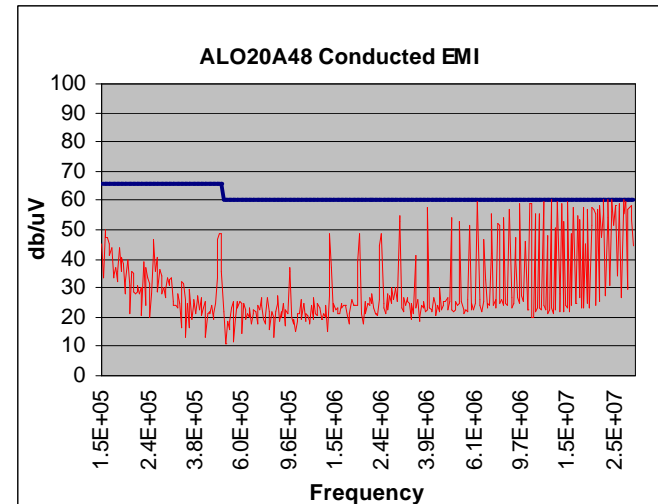

Figure 28. 5V Open frame Conducted EMI per Filter defined in Fig 89. $V_{IN} = 48Vdc$, $I_O = 50\%$ Resistive Load, $T_A = 25^\circ C$.

Performance Curves

3.3V @ 30A

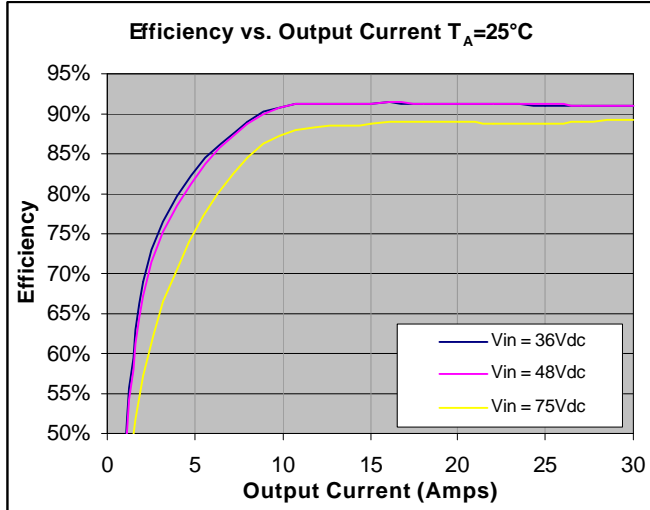

Figure 29. Efficiency vs. Load Current at minimum, nominal and high line, $T_A = 25^\circ\text{C}$.

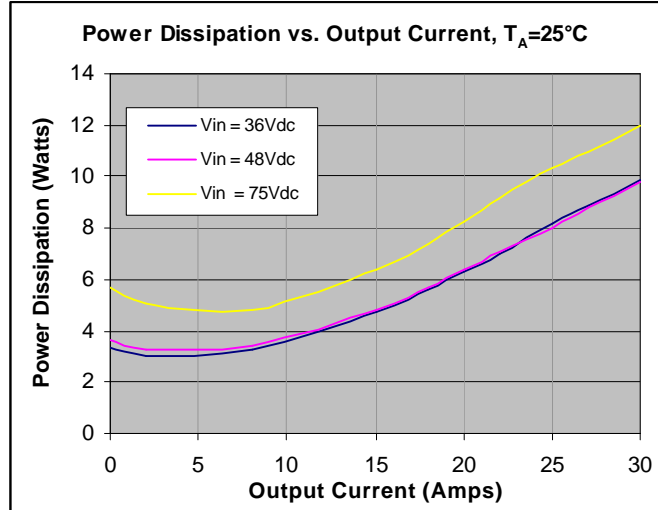

Figure 30. Power Dissipation vs. Load Current at minimum, nominal and high line, $T_A = 25^\circ\text{C}$.

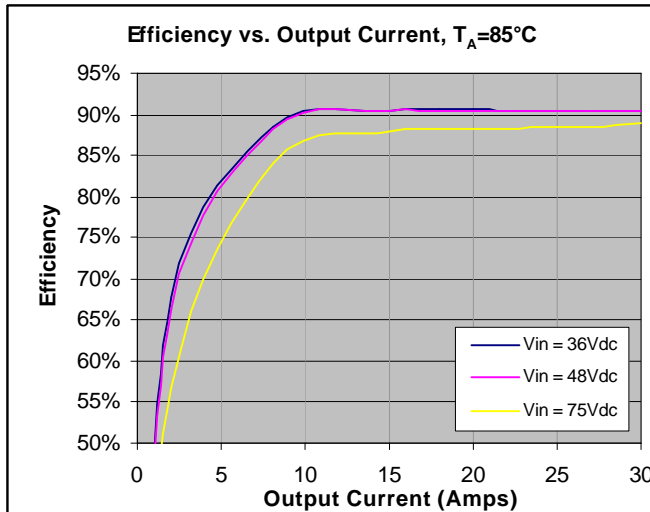

Figure 31. Efficiency vs. Load Current at minimum, nominal and high line, $T_A = 85^\circ\text{C}$.

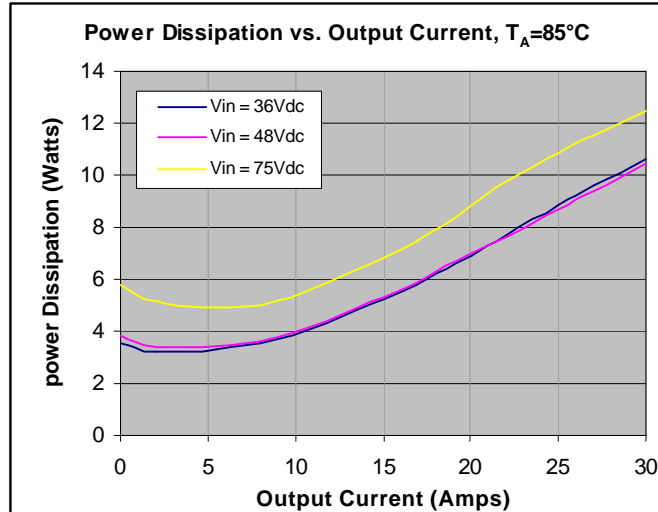

Figure 32. Power Dissipation vs. Load Current at minimum, nominal and high line, $T_A = 85^\circ\text{C}$.

Performance Curves

3.3V @ 30A (continued)

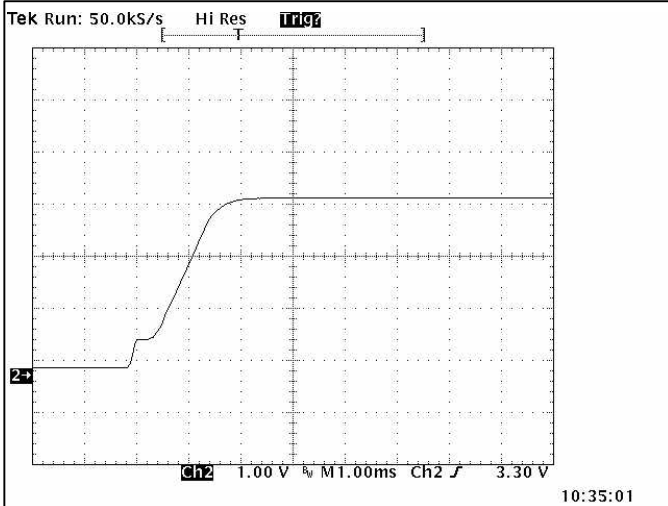

Figure 33. 3.3V output startup characteristic at $V_{IN} = 48Vdc$, $I_O = \text{Full Load}$, $T_A = 25^\circ C$, $C_O = 0$.

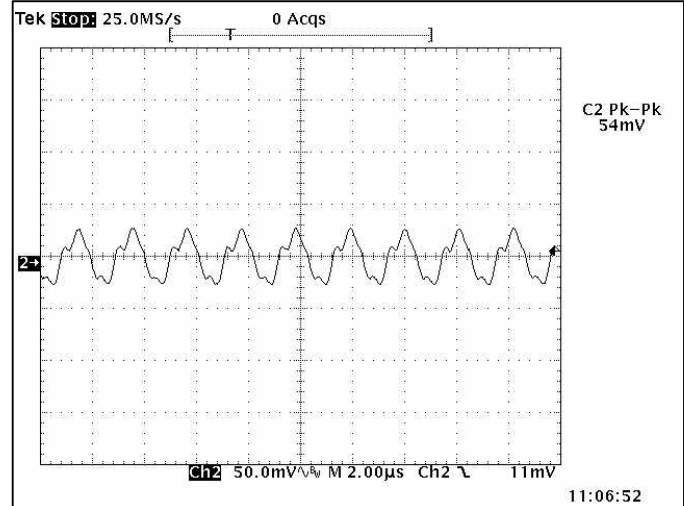

Figure 34. 3.3V output ripple at $V_{IN} = 48Vdc$, $I_O = \text{Full Load}$, $T_A = 25^\circ C$.

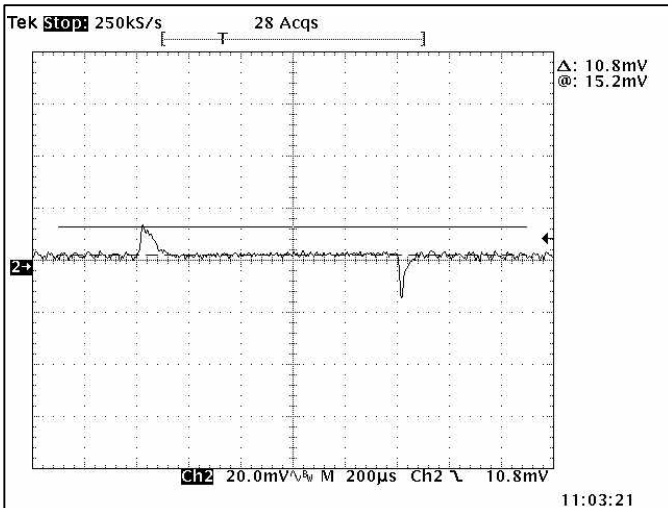

Figure 35. 3.3V output transient response 25% to 50% step change at $V_{IN} = 48Vdc$, $T_A = 25^\circ C$, $C_O = 0$.

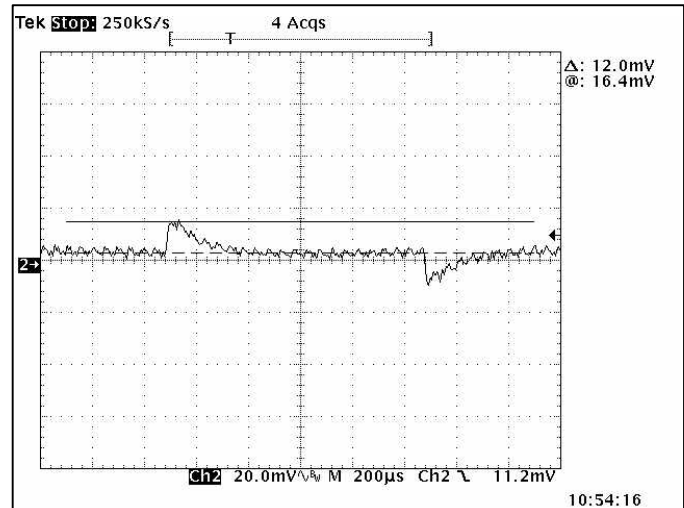

Figure 36. 3.3V output transient response 50% to 75% step change at $V_{IN} = 48Vdc$, $T_A = 25^\circ C$, $C_O = 0$.

Performance Curves

3.3V @ 30A (continued)

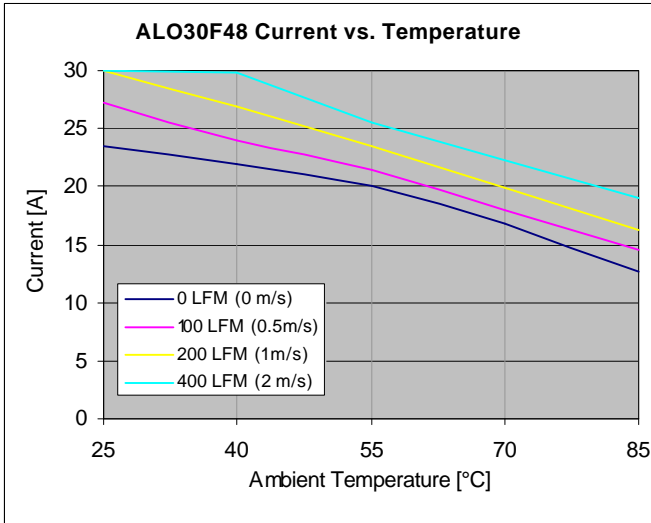

Figure 37. Output Current vs. Temperature for open frame version at $V_{IN} = 48Vdc$ ($T_J \leq 120^\circ C$).

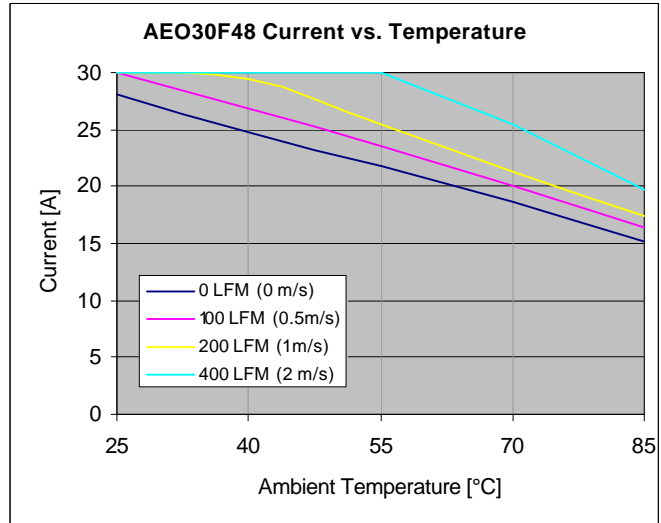

Figure 38. Output Current vs. Temperature for baseplate version at $V_{IN} = 48Vdc$ ($T_J \leq 120^\circ C$).

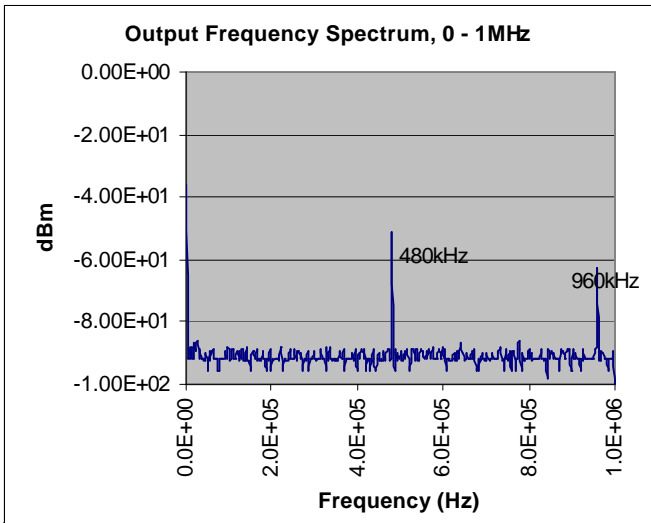

Figure 39. Typical output frequency spectrum at $V_{IN} = 48Vdc$, $I_O = 100\%$ Load, $C_{OUT} = 0$.

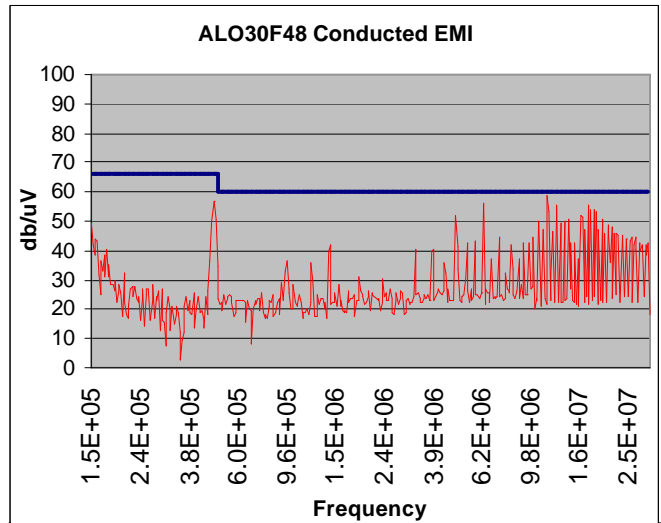

Figure 40. 3.3V Open frame Conducted EMI per Filter defined in Fig 89. $V_{IN} = 48Vdc$, $I_O = 100\%$ Resistive Load, $C_{IN} = 220\mu F$, $C_{OUT} = 4700\mu F$, $T_A = 25^\circ C$.

Performance Curves

1.8V @ 40A

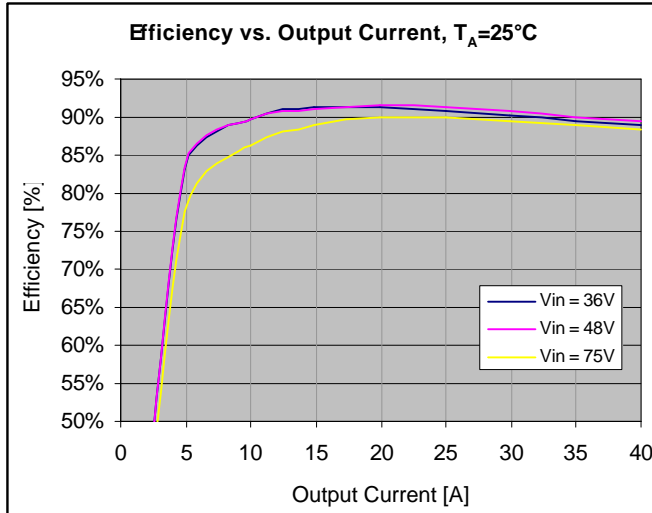

Figure 53. Efficiency vs. Load Current at minimum, nom and high line, $T_A = 25^\circ\text{C}$.

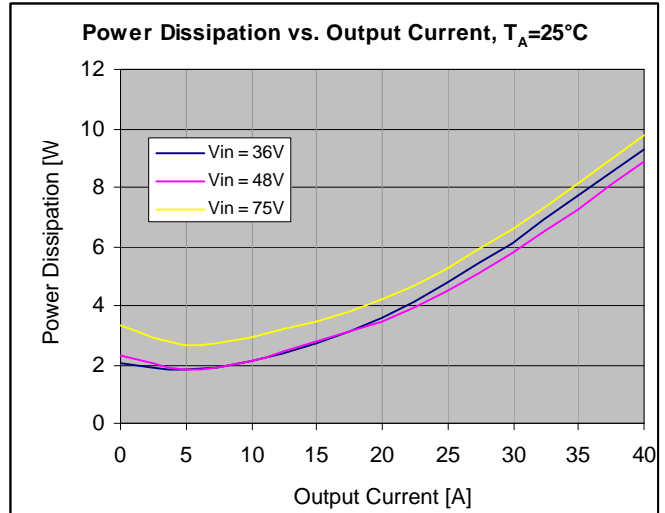

Figure 54. Power Dissipation vs. Load Current at min, nominal and high line, $T_A = 25^\circ\text{C}$.

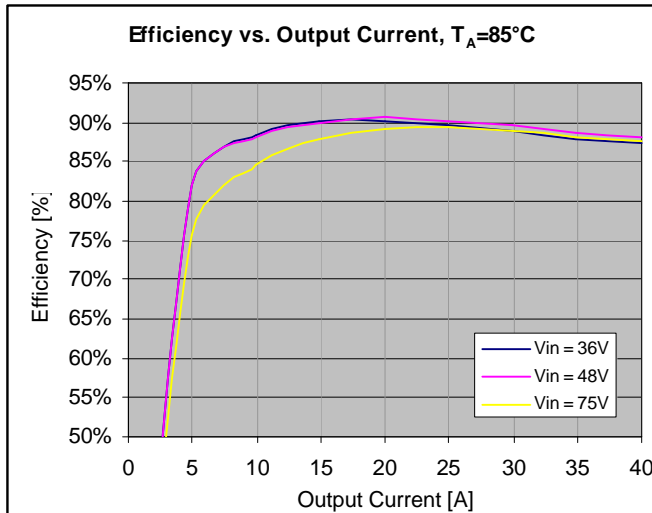

Figure 55. Efficiency vs. Load Current at minimum, nom and high line, $T_A = 85^\circ\text{C}$.

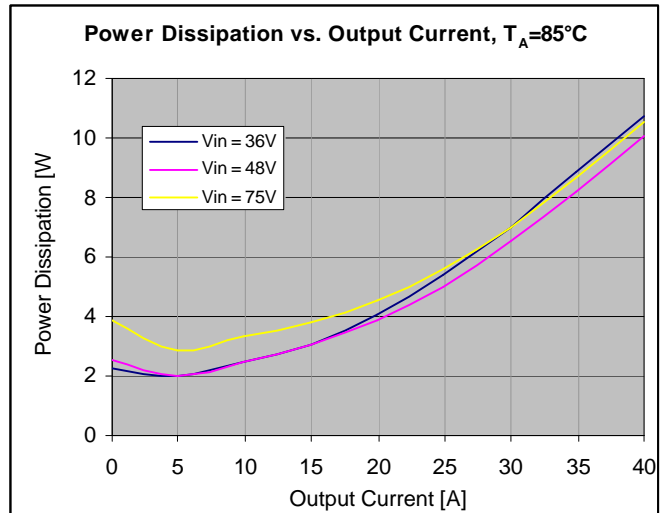

Figure 56. Power Dissipation vs. Load Current at minimum, nom and high line, $T_A = 85^\circ\text{C}$.

Performance Curves

1.8V @ 40A (continued)

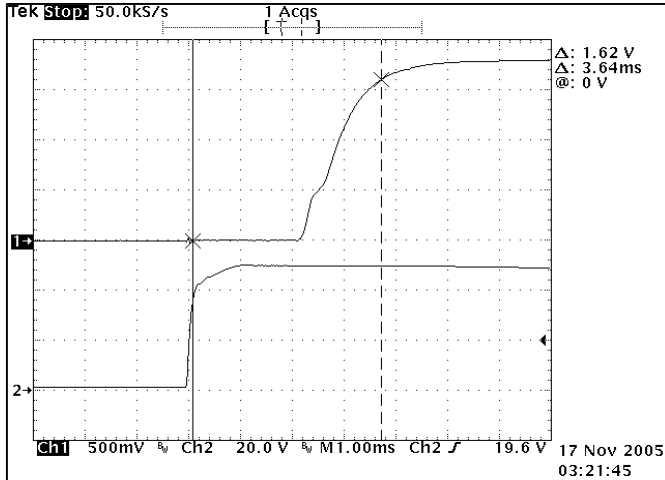

Figure 57. 1.8V [Ch1] startup characteristic at $V_{IN} = 48V$, $I_O = 40A$, $T_A = 25^\circ C$.

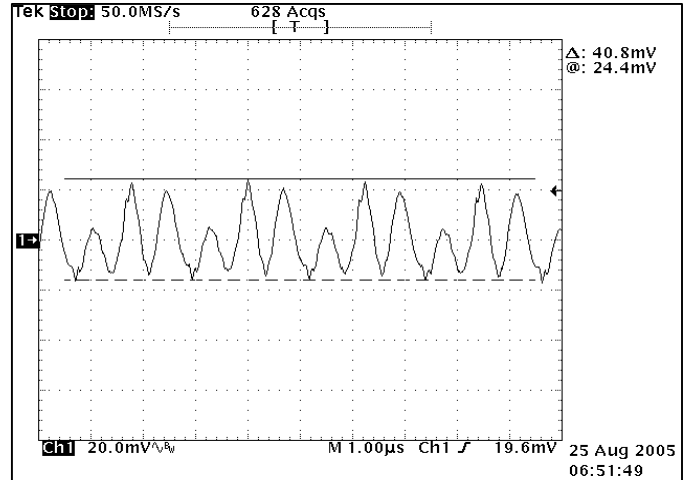

Figure 58. Output ripple at $V_{IN} = 48V$, $I_O = 40A$, $T_A = 25^\circ C$ (See Fig 2).

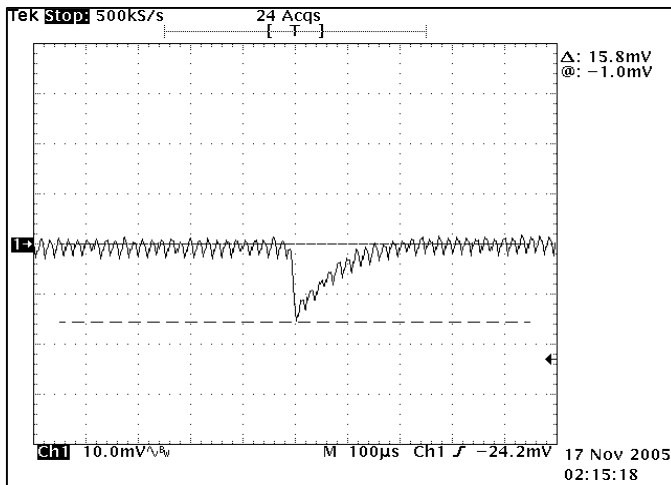

Figure 59. Output transient response at 50% to 75% step, $V_{IN} = 48V$, $T_A = 25^\circ C$, $C_O = 0$.

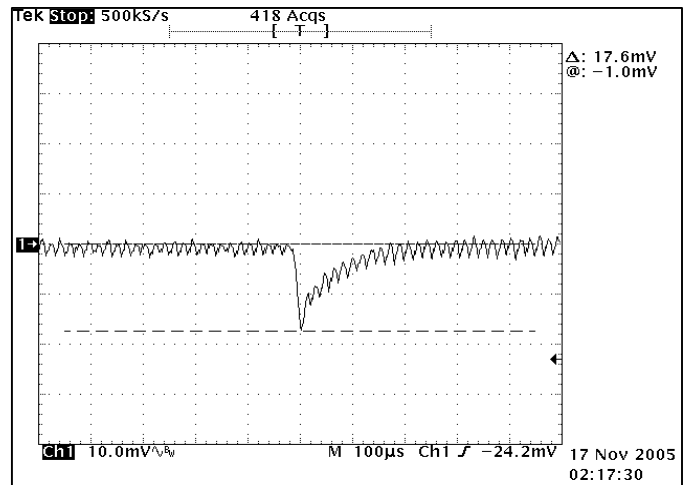

Figure 60. Output transient response at 25% to 50% step, $V_{IN} = 48V$, $T_A = 25^\circ C$, $C_O = 0$.

Performance Curves

1.8V @ 40A (continued)

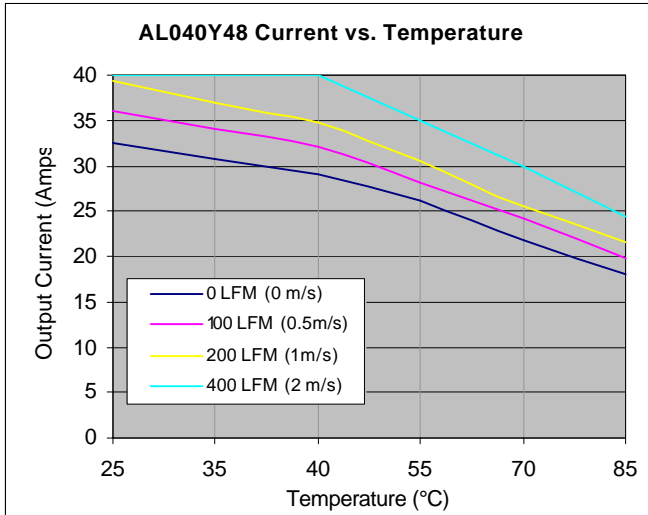

Figure 61. Output Current vs. Temperature for open frame version at $V_{IN} = 48Vdc$ ($T_J \leq 120^\circ C$).

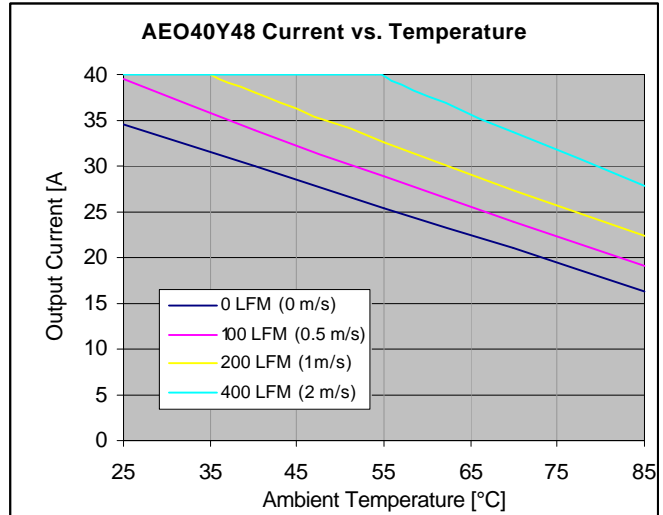

Figure 62. Output Current vs. Temperature for baseplate version at $V_{IN} = 48Vdc$ ($T_J \leq 120^\circ C$).

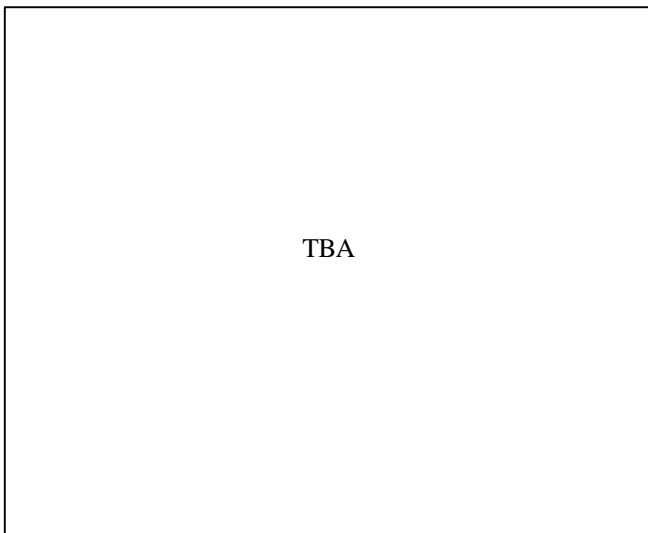

Figure 63. Typical output frequency spectrum (0 – 500kHz) at $V_{IN} = 48Vdc$, $I_O = 50\%$ Load, $C_{OUT} = 0$.

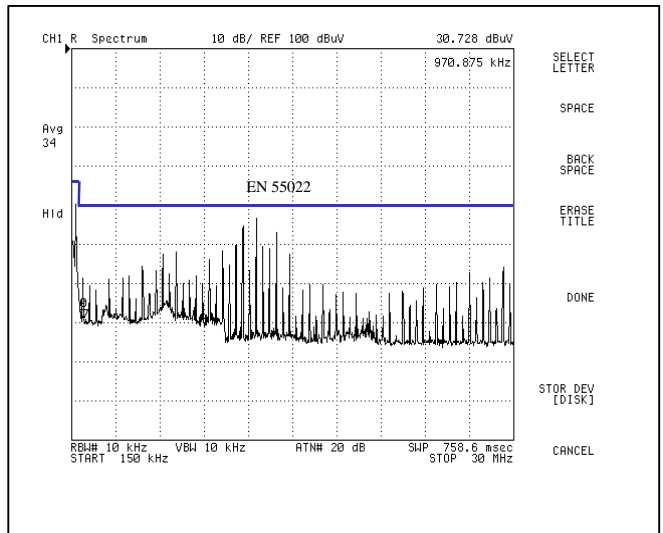

Figure 64. 1.8V Conducted EMI per Filter defined in Fig 89. $V_{IN} = 48Vdc$, $I_O = 50\%$ Resistive Load, $T_A = 25^\circ C$.

Performance Curves

1.5V @ 40A (continued)

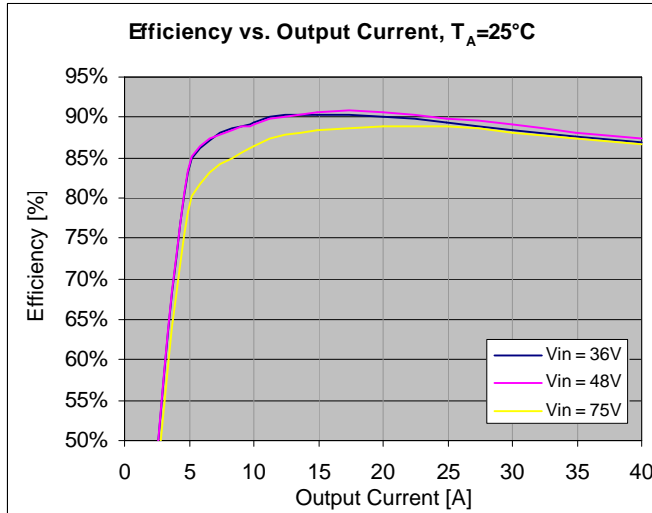

Figure 65. Efficiency vs. Load Current at minimum, nominal and high line, $T_A = 25^\circ\text{C}$.

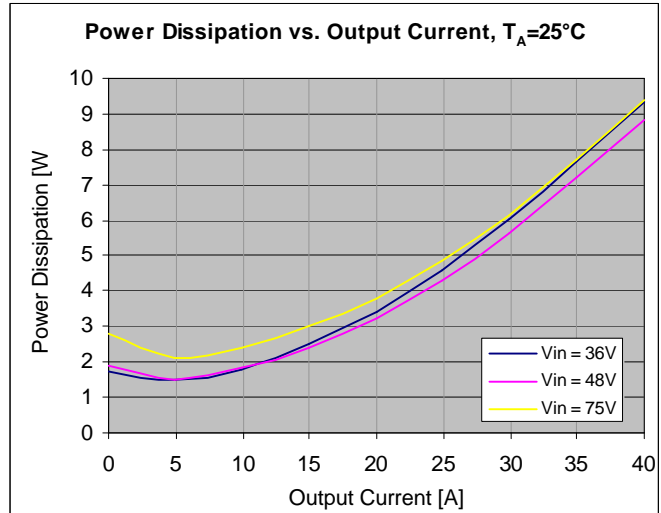

Figure 66. Power Dissipation vs. Load Current at min, nominal and high line, $T_A = 25^\circ\text{C}$.

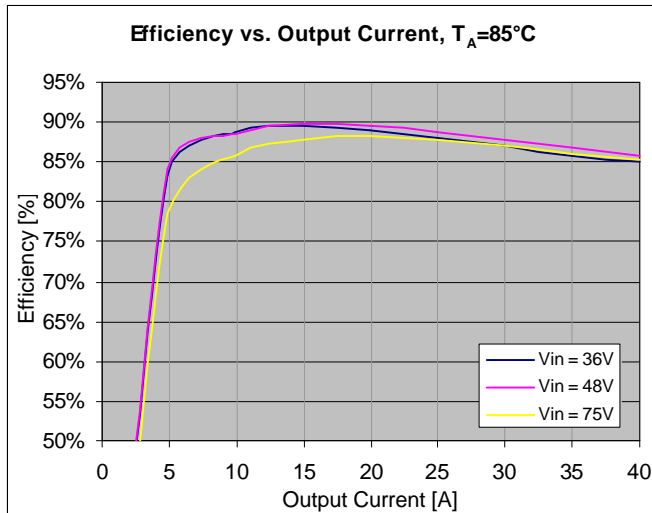

Figure 67. Efficiency vs. Load Current at minimum, nominal and high line, $T_A = 85^\circ\text{C}$.

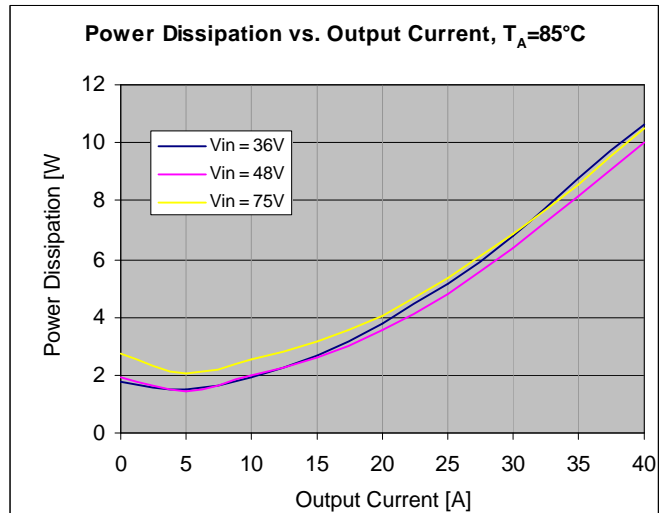

Figure 68. Power Dissipation vs. Load Current at min, nominal and high line, $T_A = 85^\circ\text{C}$.

Performance Curves

1.5V @ 40A (continued)

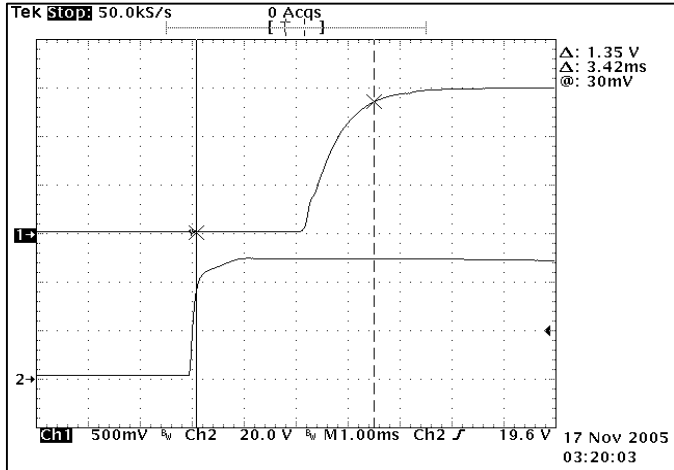

Figure 69. 1.5V [Ch1] startup characteristic at $V_{IN} = 48V$, $I_O = 40A$, $T_A = 25^\circ C$.

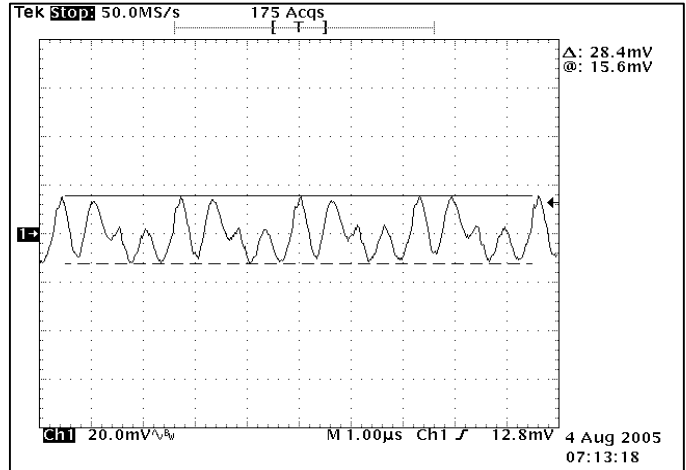

Figure 70. Output ripple at $V_{IN} = 48V$, $I_O = 40A$, $T_A = 25^\circ C$ (See Fig 2).

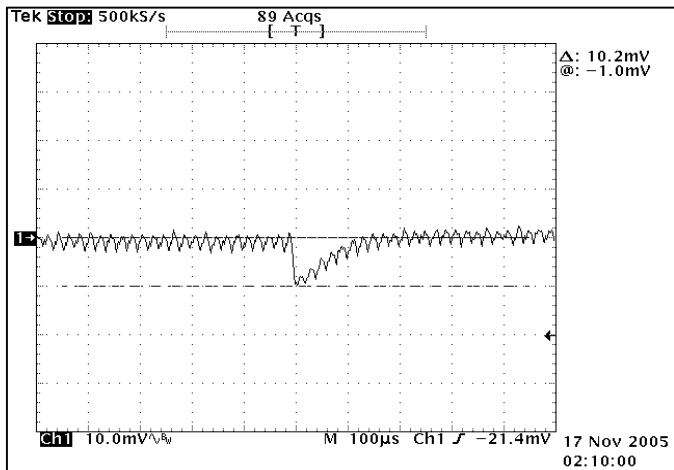

Figure 71. Output transient response at 50% to 75% step, $V_{IN} = 48V$, $T_A = 25^\circ C$, $C_O = 0$.

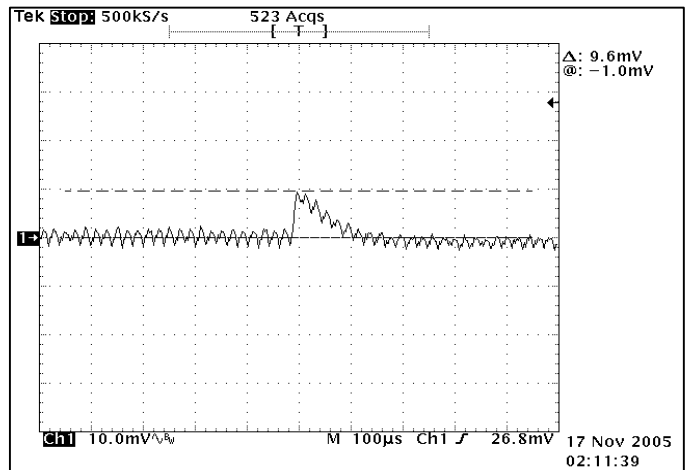

Figure 72. Output transient response at 25% to 50% step, $V_{IN} = 48V$, $T_A = 25^\circ C$, $C_O = 0$.

Performance Curves

1.5V @ 40A (continued)

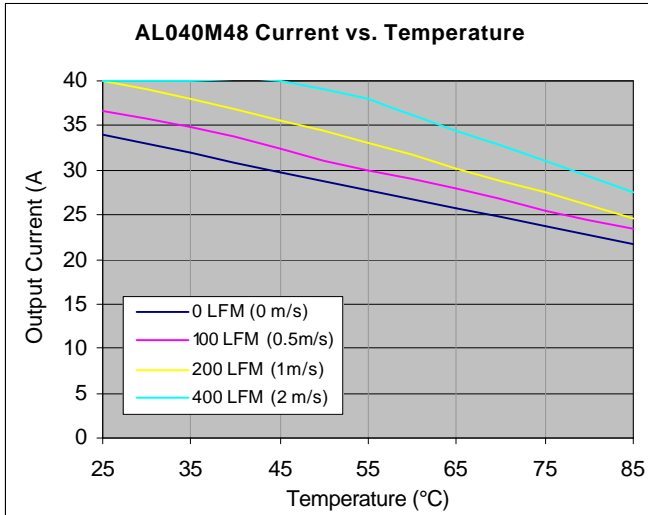

Figure 73. Output Current vs. Temperature for open frame version at $V_{IN} = 48Vdc$ ($T_J \leq 120^\circ C$).

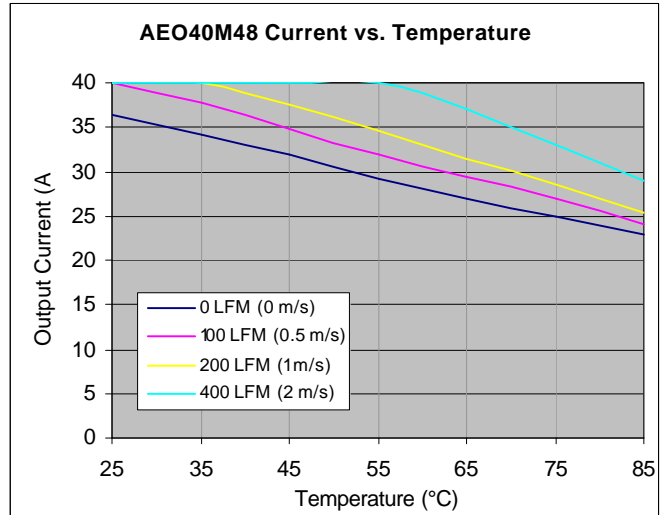

Figure 74. Output Current vs. Temperature for baseplate version at $V_{IN} = 48Vdc$ ($T_J \leq 120^\circ C$).

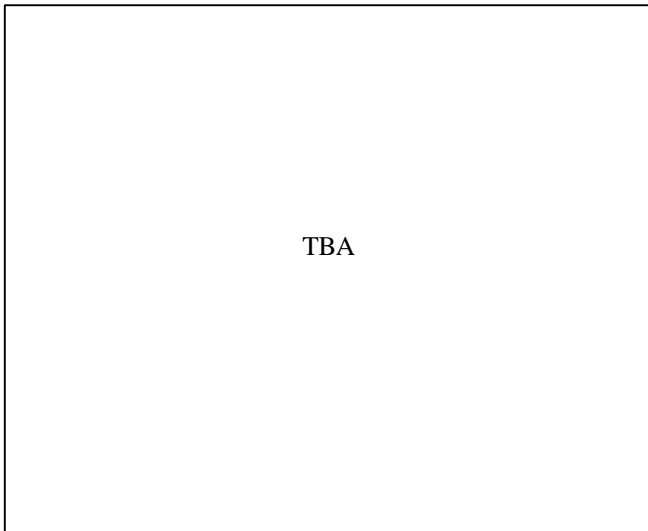

Figure 63. Typical output frequency spectrum (0 – 500kHz) at $V_{IN} = 48Vdc$, $I_O = 50\%$ Load, $C_{OUT} = 0$.

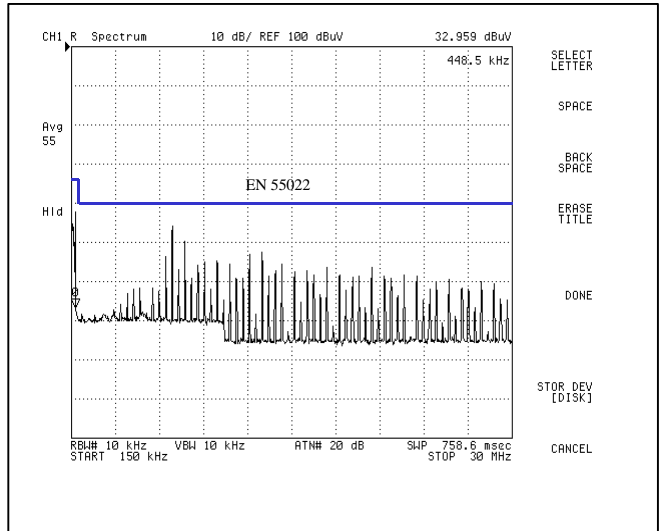

Figure 64. 1.5V Conducted EMI per Filter defined in Fig 89. $V_{IN} = 48Vdc$, $I_O = 50\%$ Resistive Load, $T_A = 25^\circ C$.

Performance Curves

1.2V @ 40A

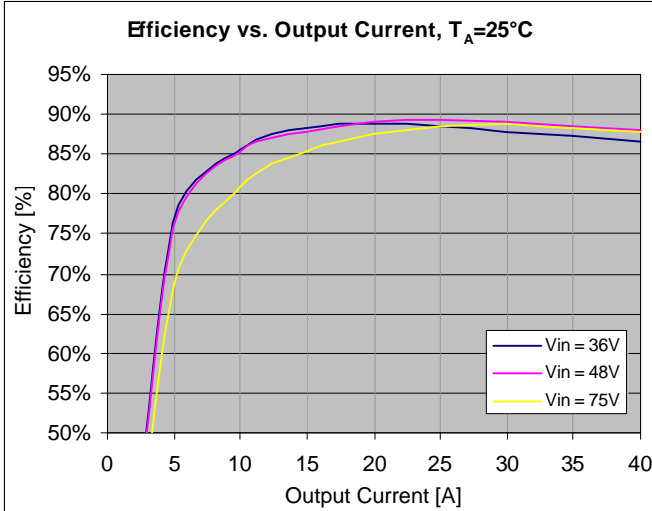

Figure 77. Efficiency vs. Load Current at minimum, nominal and high line, $T_A = 25^\circ\text{C}$.

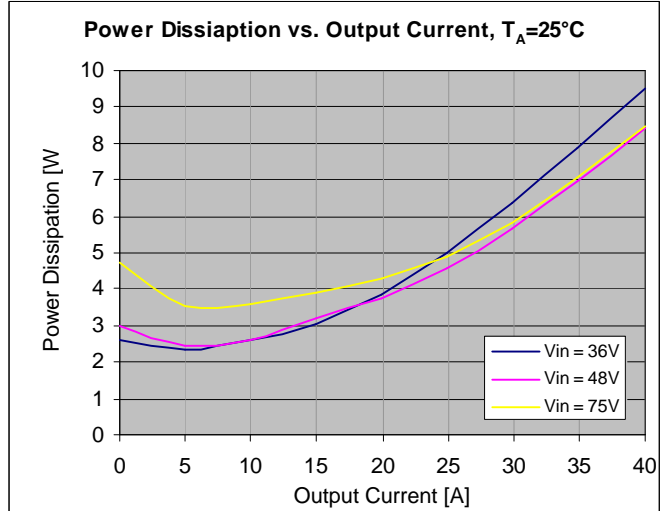

Figure 78. Power Dissipation vs. Load Current at min, nominal and high line, $T_A = 25^\circ\text{C}$.

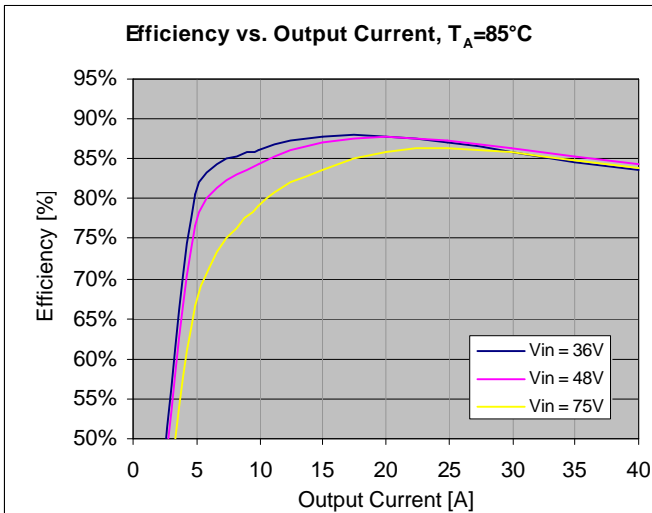

Figure 79. Efficiency vs. Load Current at minimum, nominal and high line, $T_A = 85^\circ\text{C}$.

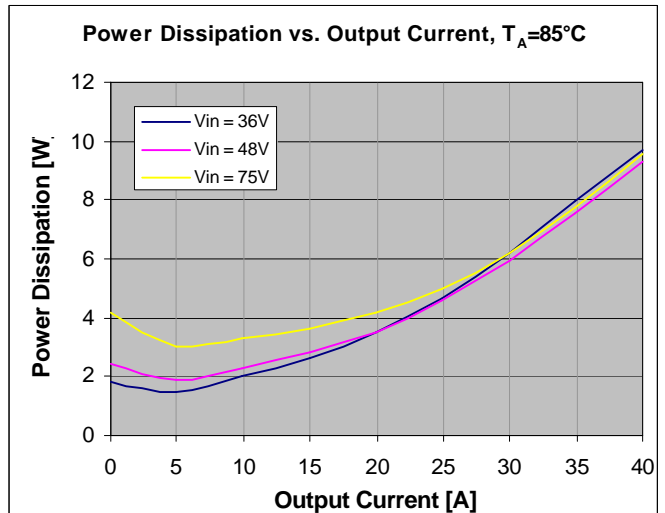

Figure 80. Power Dissipation vs. Load Current at min, nominal and high line, $T_A = 85^\circ\text{C}$.

Performance Curves

1.2V @ 40A (continued)

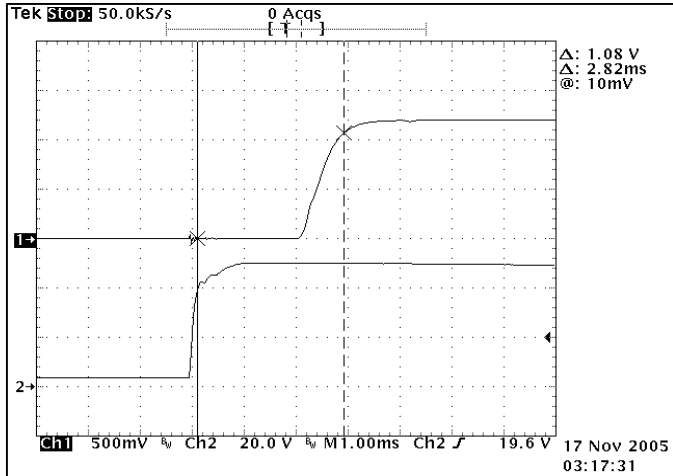

Figure 81. 1.5V [Ch1] startup characteristic at $V_{IN} = 48V$, $I_O = 40A$, $T_A = 25^\circ C$.

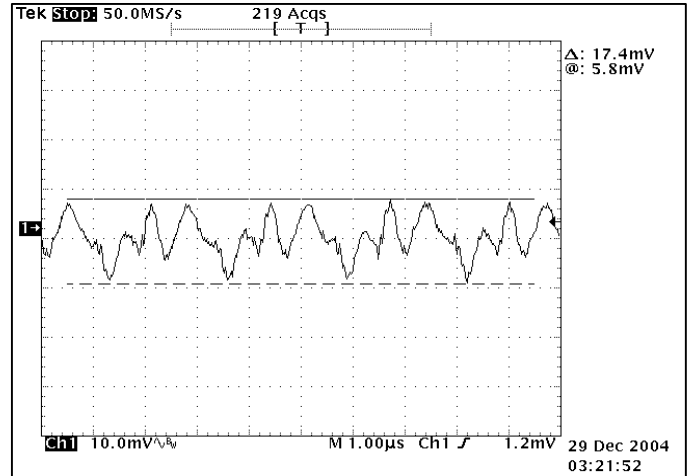

Figure 82. Output ripple at $V_{IN} = 48V$, $I_O = 40A$, $T_A = 25^\circ C$ (See Fig 2).

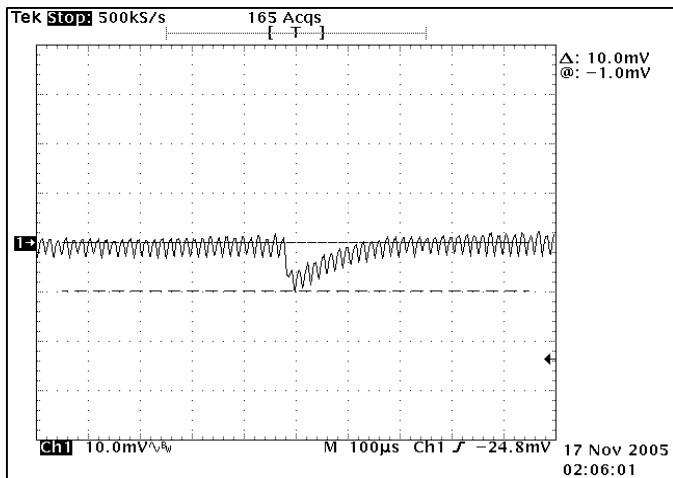

Figure 83. Output transient response at 50% to 75% step, $V_{IN} = 48V$, $T_A = 25^\circ C$, $C_O = 0$.

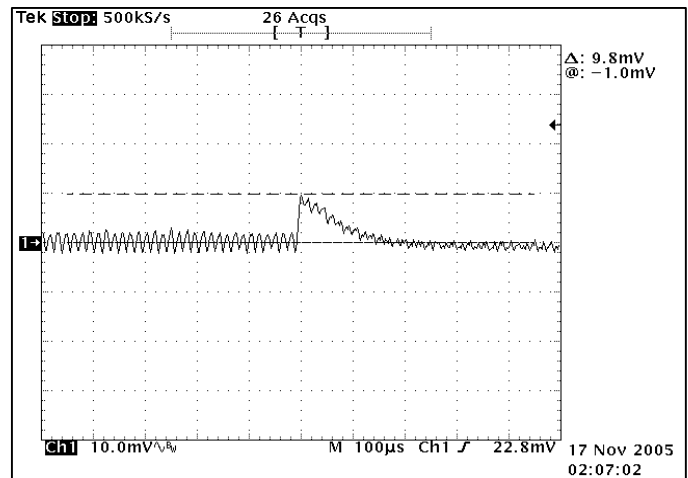

Figure 84. Output transient response at 25% to 50% step, $V_{IN} = 48V$, $T_A = 25^\circ C$, $C_O = 0$.

Performance Curves

1.2V @ 40A (continued)

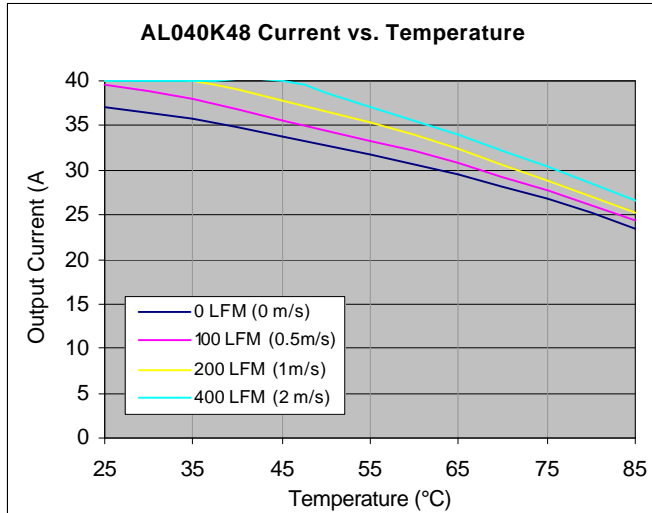

Figure 85. Output Current vs. Temperature for open frame version at $V_{IN} = 48Vdc$ ($T_J \leq 120^\circ C$).

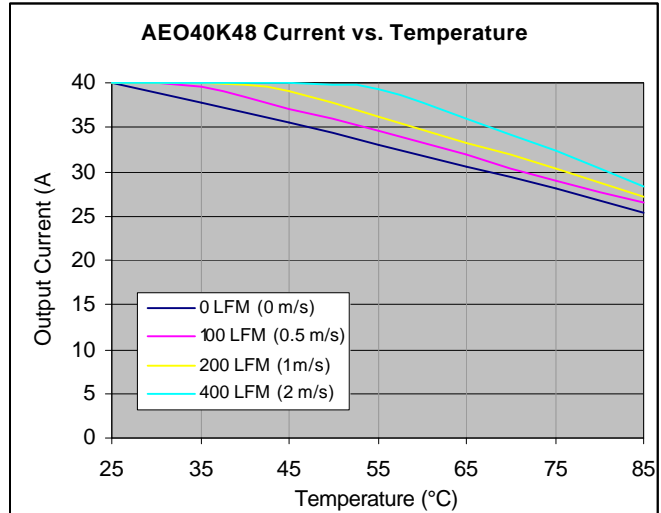

Figure 86. Output Current vs. Temperature for baseplate version at $V_{IN} = 48Vdc$ ($T_J \leq 120^\circ C$).

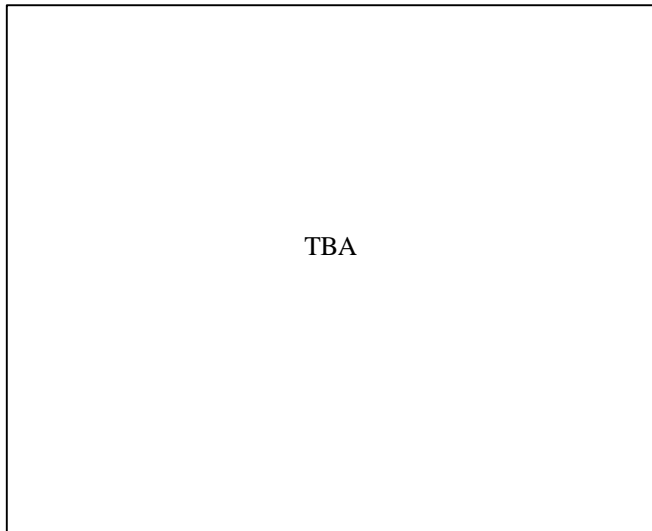

Figure 63. Typical output frequency spectrum (0 – 500kHz) at $V_{IN} = 48Vdc$, $I_O = 50\%$ Load, $C_{OUT} = 0$.

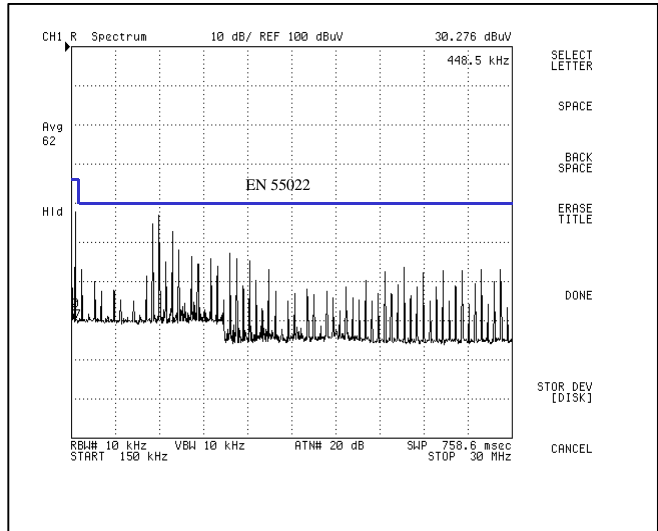

Figure 64. 1.2V Conducted EMI per Filter defined in Fig 89. $V_{IN} = 48Vdc$, $I_O = 50\%$ Resistive Load, $T_A = 25^\circ C$.

Input Filter for FCC Class B Conducted Noise

A reference design for an input filter that can provide FCC Class B conducted noise levels is shown below (See Figure 89). Two common mode connected inductors are used in the circuit along with balanced bypass capacitors to shunt common mode currents into the ground plane. Shunting noise current back to the converter reduces the amount of energy reaching the input LISN for measurement.

The application circuit shown has an earth ground (frame ground) connected to the converter output (-) terminal. Such a configuration is common practice to accommodate safety agency requirements. Grounding an output terminal results in much higher conducted emissions as measured at the input LISN because a hard path for common mode current back to the LISN is created by the frame ground. “Floating” loads generally result in much lower measured emissions. The electrical equivalent of a floating load, for EMI measurement purposes, can be created by grounding the converter output (load) through a suitably sized inductor(s) while maintaining the necessary safety bonding.

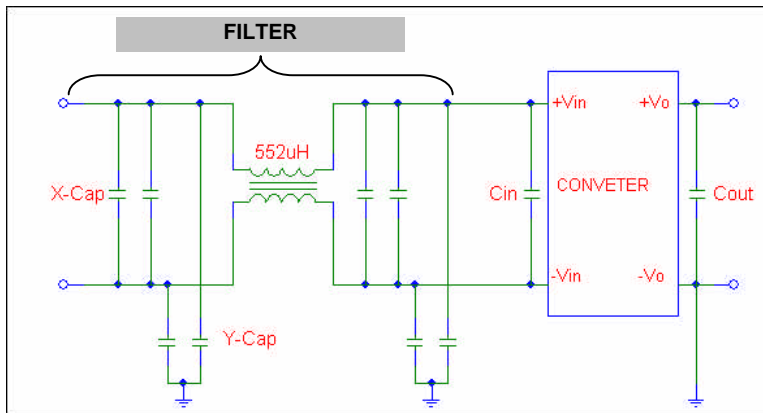

Figure 89: Class B Filter Circuit

PARTS LIST

CKT CODE	DESCRIPTION
Common Mode Choke	CTX01-15091 Cooper Electronic Technologies
X-Cap	0.47 μ F X 4pcs
Y-Cap	22 nF X 4 pcs
C _{IN}	220 μ F X 1pc

Mechanical Specifications

Parameter	Device	Symbol	Min	Typ	Max	Unit
Dimension	All	L	-	2.30 [58.42]	-	in [mm]
		W	-	1.48 [37.59]	-	in [mm]
	AEO	H	-	-	0.40 [10.1]	in [mm]
	ALO	H	-	-	0.32 [8.2]	in [mm]
Weight	AEO		-	34.02 [1.2]	-	g [oz]
	ALO		-	22.68 [0.8]	-	g [oz]
PIN ASSIGNMENT						
1		+V _{IN}		5		-SENSE
2		ENABLE		6		TRIM
3		-V _{IN}		7		+SENSE
4		-V _O		8		+V _O

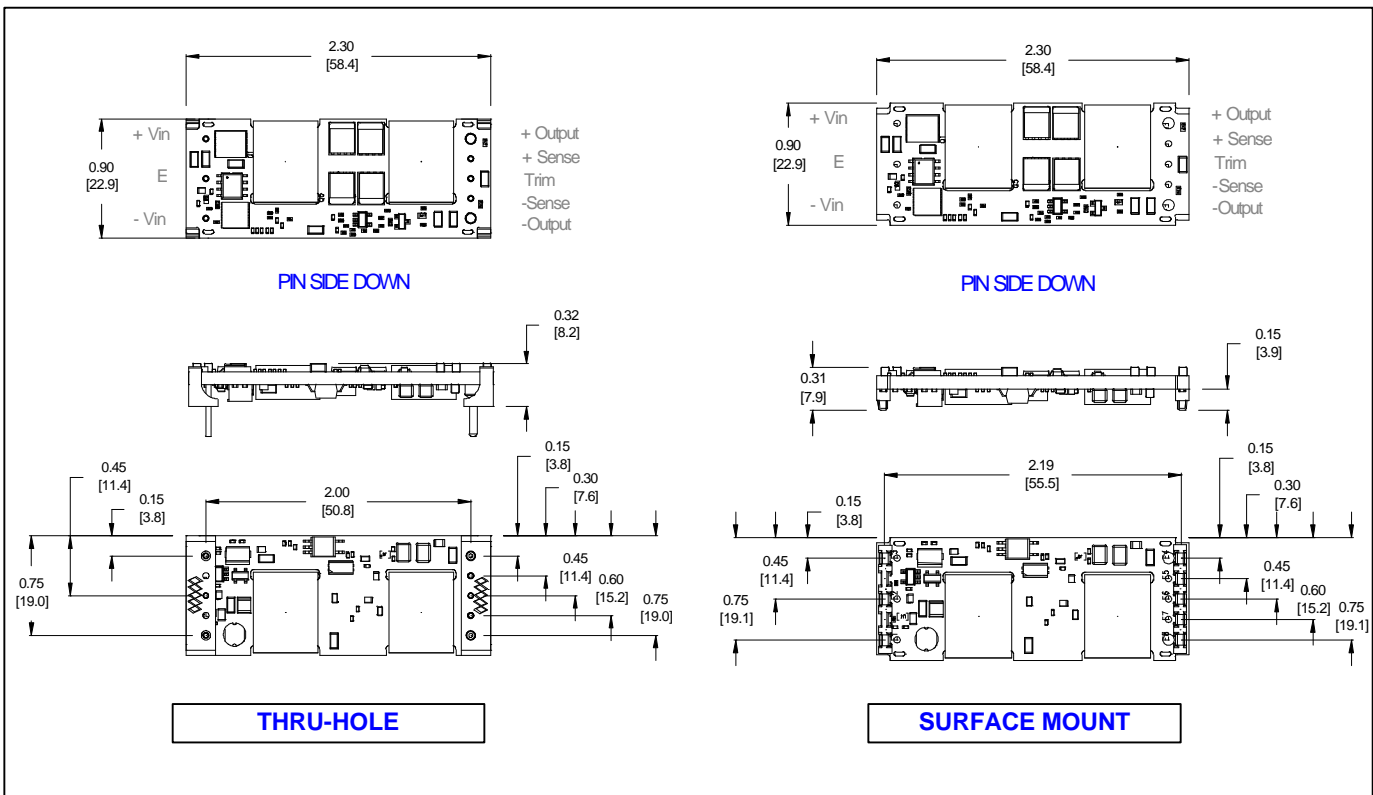

Figure 90A. ALO (Openframe) Mechanical outline.

Mechanical Specifications

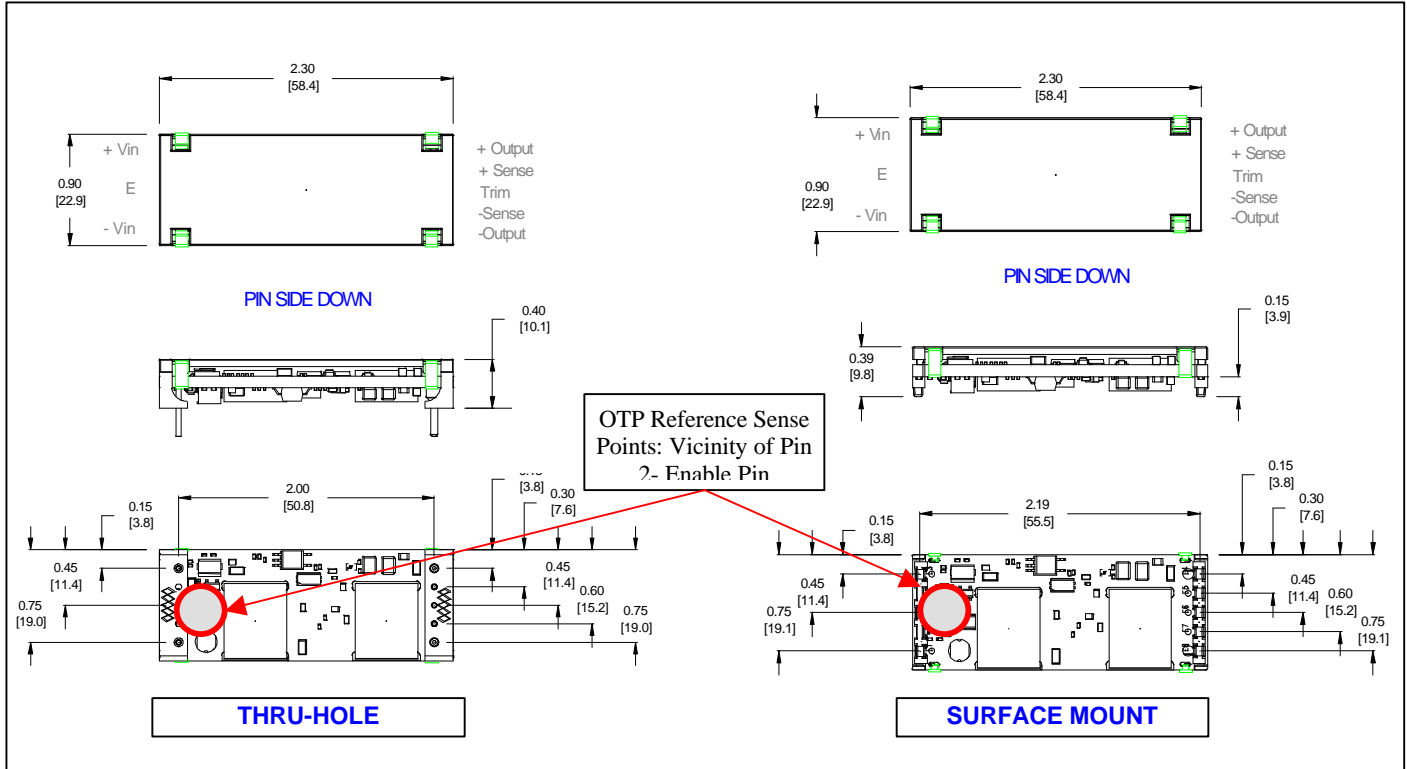

Figure 90B. AEO (Baseplate) Mechanical Outline.

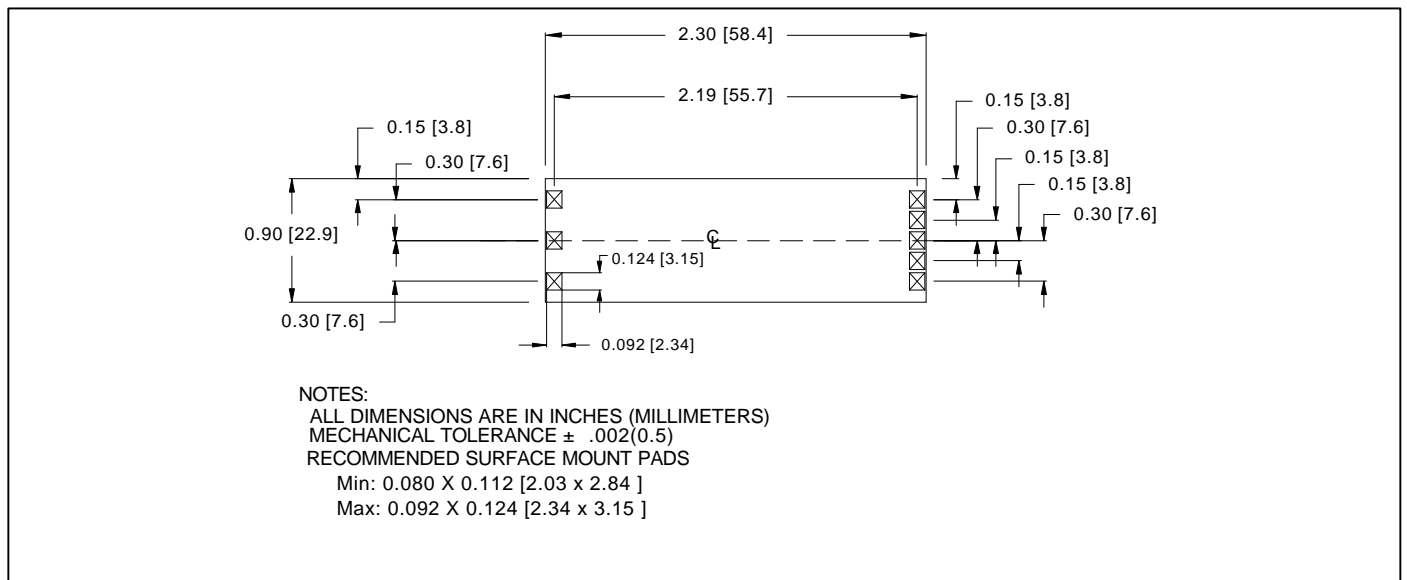

Figure 91. Recommended Pad layout for SMT (Suffix "S") version.



Technical Reference Notes

AEO_ALO40/35/30/20/10x48 Series

(Single Output 8th Brick)



SOLDERING CONSIDERATIONS

The AEO and ALO series converters are compatible with standard wave soldering techniques. When wave soldering, the converter pins should be preheated for 20-30 sec at 110°C and wave soldered at 260°C for less than 10 sec.

When hand soldering, the iron temperature should be maintained at 425°C and applied to the converter pins for less than 5 seconds. Longer exposure can cause internal damage to the converter. Cleaning can be performed with cleaning solvent IPA or with water.

For SMT terminated modules, refer to Figure 92 for the recommended reflow profile.

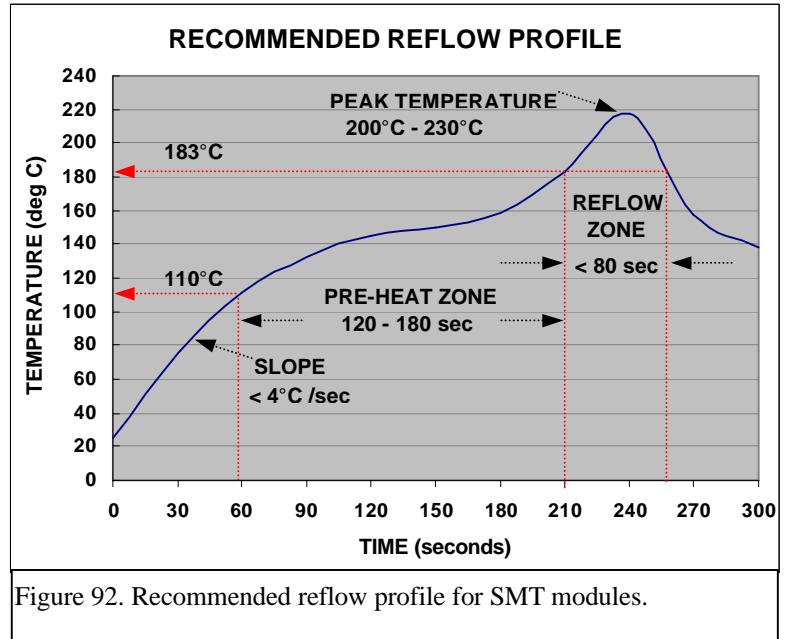

TABLE 2: PART NUMBERING SCHEME

A	CONSTRUCTION	O	O/P CURRENT	O/P VOLTAGE	Vin	Enable	-	TH PIN LENGTH	TERMINATION
	W		xx	y	48	N	-	6	S
	L = Open frame E = Baseplate		10 = 10A 20 = 20A 30 = 30A 35 = 35A 40 = 40A 40 = 40A 40 = 40A	B = 12V A = 5.0V F = 3.3V G = 2.5V Y = 1.8V M = 1.5V K = 1.2V		N = Negative Blank = Positive		6 = 3.7mm blank = 5mm default	S = SMT Termination (option exists for 30A and below) Blank = (TH) thru-hole

Note: 1) For Through Hole termination:

- Std pin length is 5mm nominal (min: 0.189 [4.8]; max: 0.205 [5.2] / in [mm])
- "-6" option is 3.7mm nominal (min: 0.137 [3.5]; max: 0.152 [3.9] / in [mm])
- Pins 4&8 diameter: Ø = 0.062 [1.57], others: Ø = 0.04 [1.0] (6X)

Please call 1-888-41-ASTEC for further inquiries or visit us at www.astecpower.com