

Silicon PIN Diodes

- Current-controlled RF resistor for switching and attenuating applications
- Frequency range above 10 MHz up to 6 GHz
- Especially useful as antenna switch in mobile communication
- Very low capacitance at zero volt reverse bias at frequencies above 1 GHz (typ. 0.15 pF)
- Low forward resistance
- Very low harmonic distortion
- Pb-free (RoHS compliant) package
- Qualified according AEC Q101¹⁾

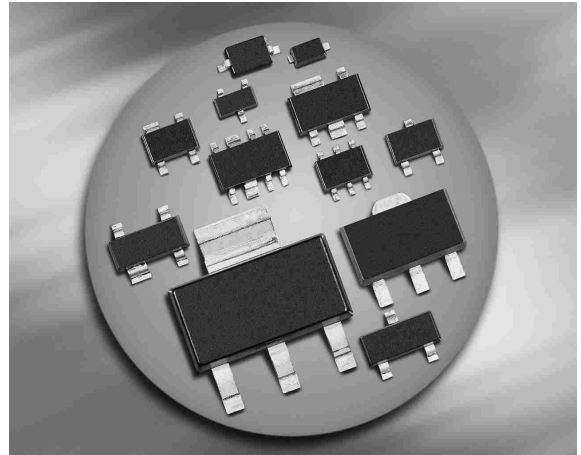

BAR50-02L
BAR50-02V
BAR50-03W

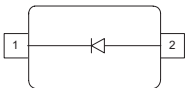

Type	Package	Configuration	L_S (nH)	Marking
BAR50-02L*	TSLP-2-1	single, leadless	0.4	AB
BAR50-02V	SC79	single	0.6	a
BAR50-03W	SOD323	single	1.8	blue A

¹⁾BAR50-02L is not qualified according AEC Q101

Maximum Ratings at $T_A = 25^\circ\text{C}$, unless otherwise specified

Parameter	Symbol	Value	Unit
Diode reverse voltage	V_R	50	V
Forward current	I_F	100	mA
Total power dissipation BAR50-02L, $T_S \leq 130^\circ\text{C}$ BAR50-02V, $T_S \leq 120^\circ\text{C}$ BAR50-03W, $T_S \leq 115^\circ\text{C}$	P_{tot}	250 250 250	mW
Junction temperature	T_j	150	°C
Operating temperature range	T_{op}	-55 ... 125	
Storage temperature	T_{stg}	-55 ... 150	

Thermal Resistance

Parameter	Symbol	Value	Unit
Junction - soldering point ¹⁾ BAR50-02L BAR50-02V BAR50-03W	R_{thJS}	≤ 80 ≤ 120 ≤ 140	K/W

Electrical Characteristics at $T_A = 25^\circ\text{C}$, unless otherwise specified

Parameter	Symbol	Values			Unit
		min.	typ.	max.	

DC Characteristics

Reverse current $V_R = 50\text{ V}$	I_R	-	-	50	nA
Forward voltage $I_F = 50\text{ mA}$	V_F	-	0.95	1.1	V

¹⁾For calculation of R_{thJA} please refer to Application Note Thermal Resistance

Electrical Characteristics at $T_A = 25^\circ\text{C}$, unless otherwise specified

Parameter	Symbol	Values			Unit
		min.	typ.	max.	
AC Characteristics					
Diode capacitance	C_T	-	0.24	0.5	pF
$V_R = 1\text{ V}, f = 1\text{ MHz}$		-	0.2	0.4	
$V_R = 5\text{ V}, f = 1\text{ MHz}$		-	0.2	-	
$V_R = 0\text{ V}, f = 100\text{ MHz}$		-	0.1	-	
$V_R = 0\text{ V}, f = 1\dots 1.8\text{ GHz}, \text{BAR50-02L}$		-	0.15	-	
$V_R = 0\text{ V}, f = 1\dots 1.8\text{ GHz}, \text{all other}$					
Reverse parallel resistance	R_P	-	25	-	k Ω
$V_R = 0\text{ V}, f = 100\text{ MHz}$		-	6	-	
$V_R = 0\text{ V}, f = 1\text{ GHz}$		-	5	-	
$V_R = 0\text{ V}, f = 1.8\text{ GHz}$					
Forward resistance	r_f	-	25	40	Ω
$I_F = 0.5\text{ mA}, f = 100\text{ MHz}$		-	16.5	25	
$I_F = 1\text{ mA}, f = 100\text{ MHz}$		-	3	4.5	
$I_F = 10\text{ mA}, f = 100\text{ MHz}$					
Charge carrier life time	τ_{rr}	-	1100	-	ns
$I_F = 10\text{ mA}, I_R = 6\text{ mA}, \text{measured at } I_R = 3\text{ mA}, R_L = 100\ \Omega$					
I-region width	W_I	-	56	-	μm
Insertion loss ¹⁾	I_L	-	0.56	-	dB
$I_F = 3\text{ mA}, f = 1.8\text{ GHz}$		-	0.4	-	
$I_F = 5\text{ mA}, f = 1.8\text{ GHz}$		-	0.27	-	
$I_F = 10\text{ mA}, f = 1.8\text{ GHz}$					
Isolation ¹⁾	I_{SO}	-	24.5	-	
$V_R = 0\text{ V}, f = 0.9\text{ GHz}$		-	20	-	
$V_R = 0\text{ V}, f = 1.8\text{ GHz}$		-	18	-	
$V_R = 0\text{ V}, f = 2.45\text{ GHz}$		-	12	-	
$V_R = 0\text{ V}, f = 5.6\text{ GHz}$					

¹BAR50-02L in series configuration, $Z = 50\ \Omega$

Diode capacitance $C_T = f(V_R)$

$f =$ Parameter

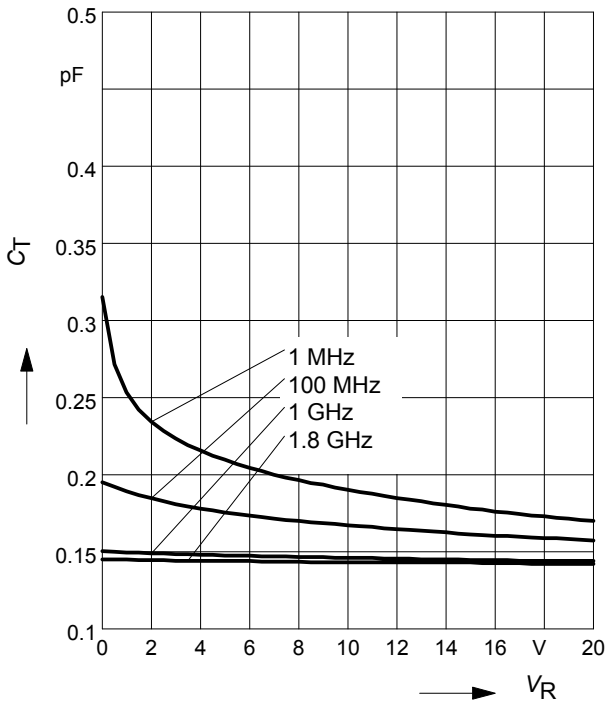

Reverse parallel resistance $R_p = f(V_R)$

$f =$ Parameter

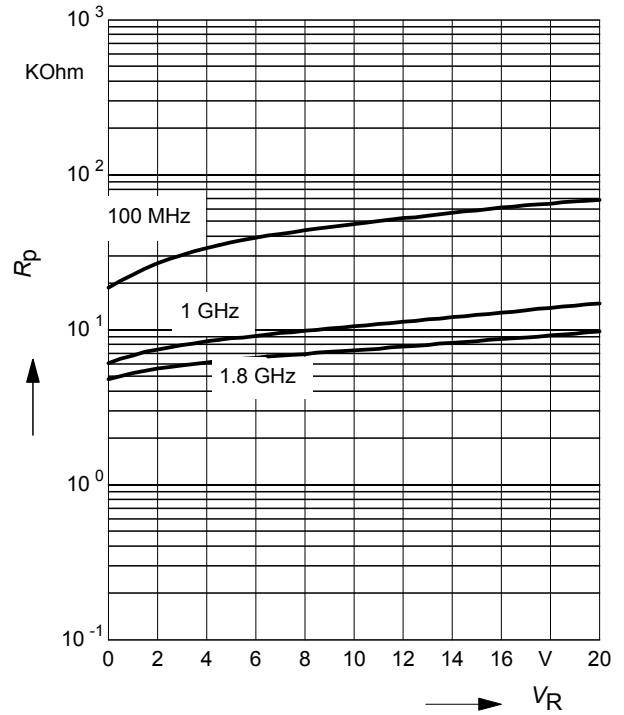

Forward resistance $r_f = f(I_F)$

$f = 100$ MHz

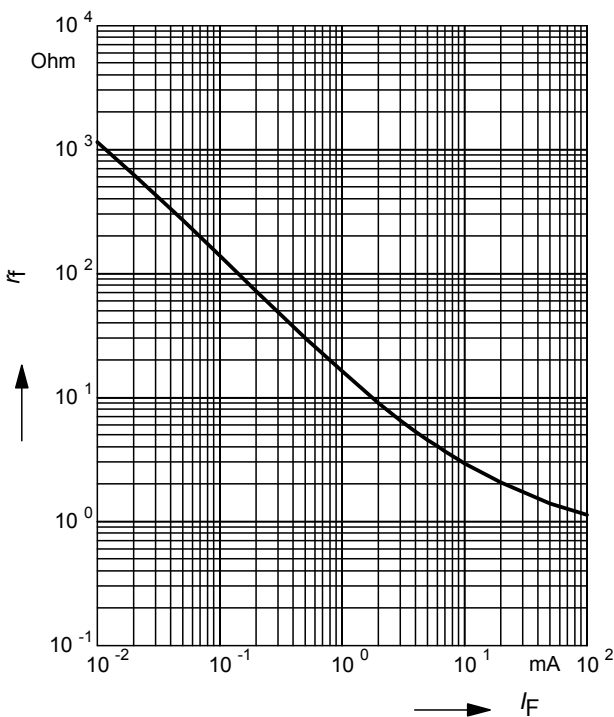

Forward current $I_F = f(V_F)$

$T_A =$ Parameter

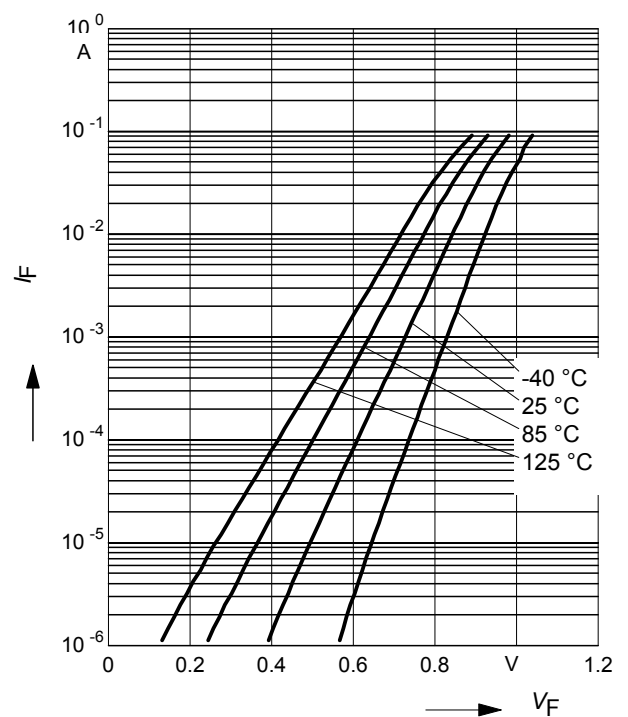

Forward current $I_F = f(T_S)$

BAR50-02L

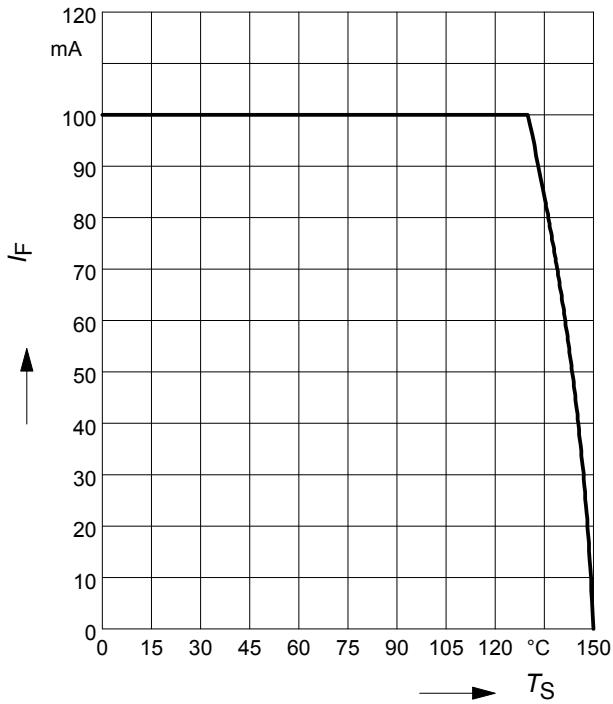

Forward current $I_F = f(T_S)$

BAR50-02V

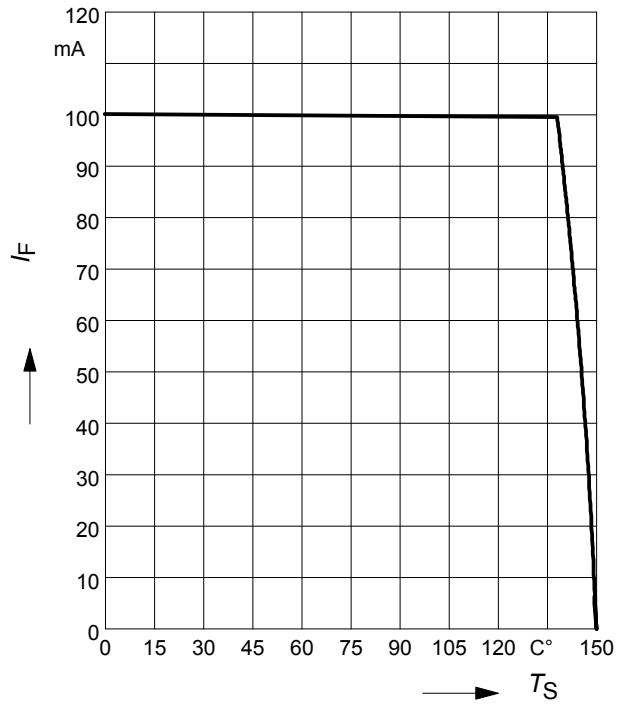

Forward current $I_F = f(T_S)$

BAR50-03W

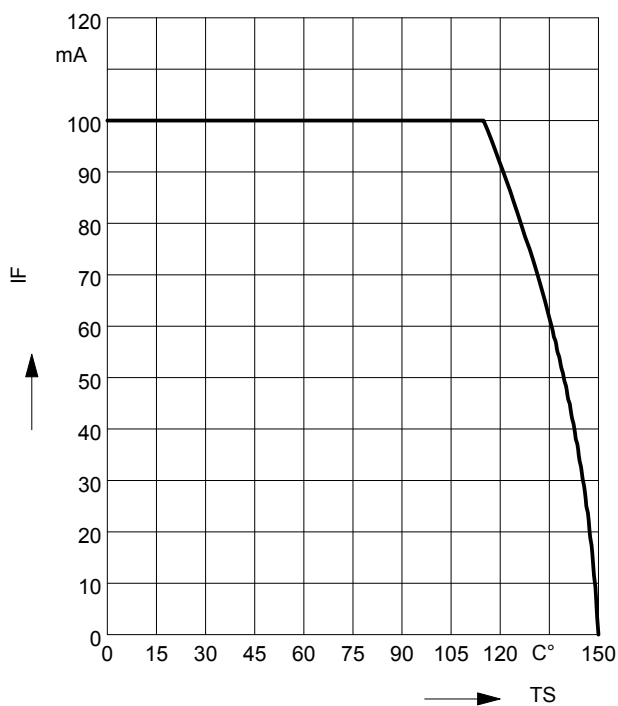

Permissible Pulse Load $R_{thJS} = f(t_p)$

BAR50-02L

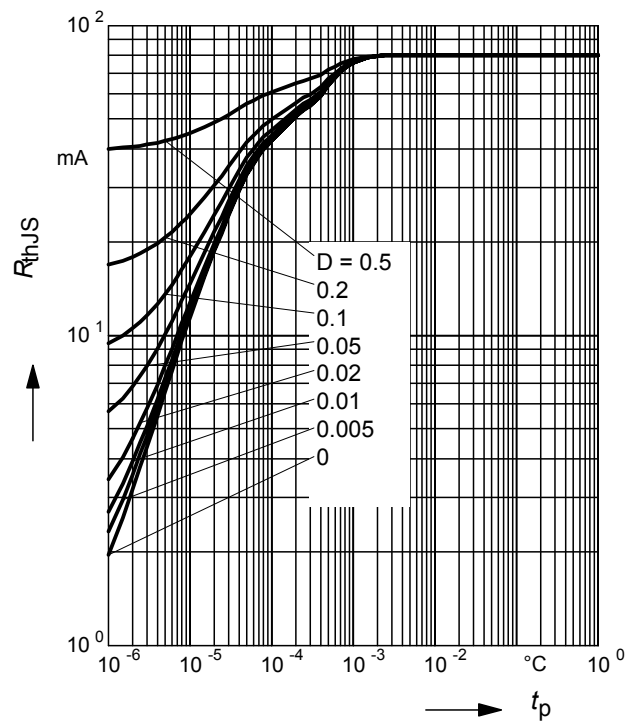

Permissible Pulse Load

$$I_{Fmax} / I_{FDC} = f(t_p)$$

BAR50-02L

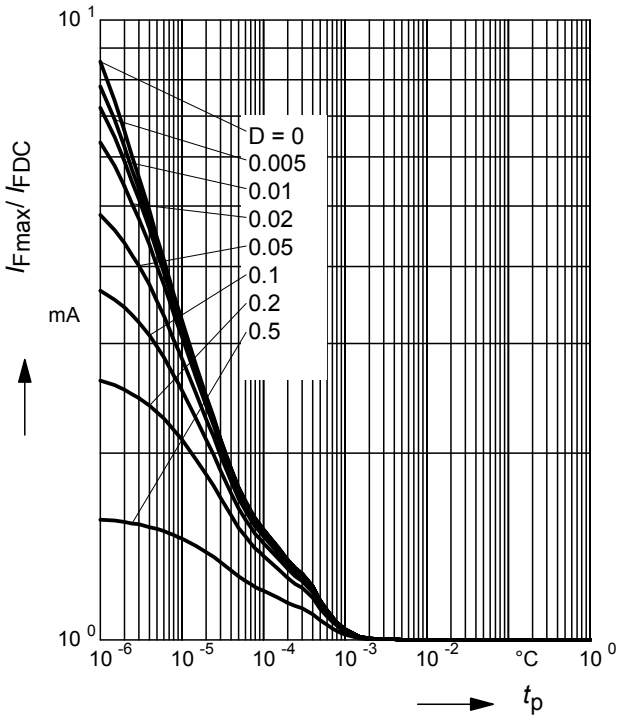

Permissible Pulse Load $R_{thJS} = f(t_p)$

BAR50-02V

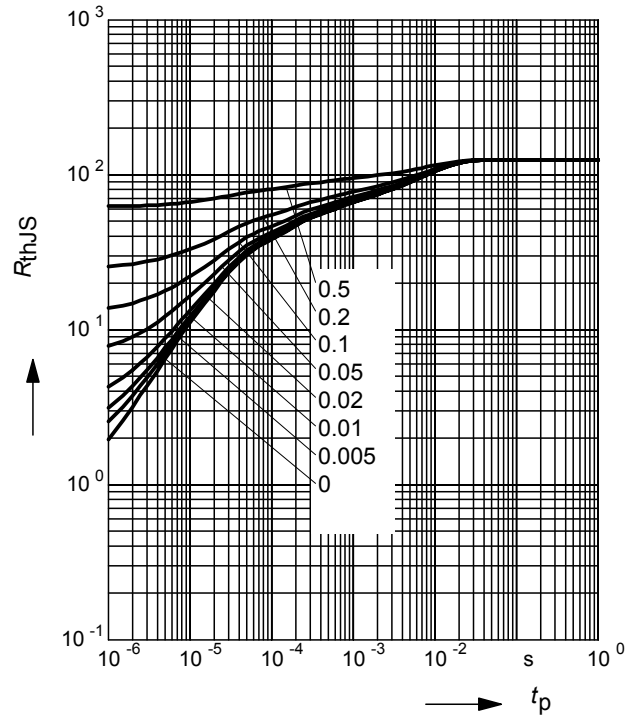

Permissible Pulse Load

$$I_{Fmax} / I_{FDC} = f(t_p)$$

BAR50-02V

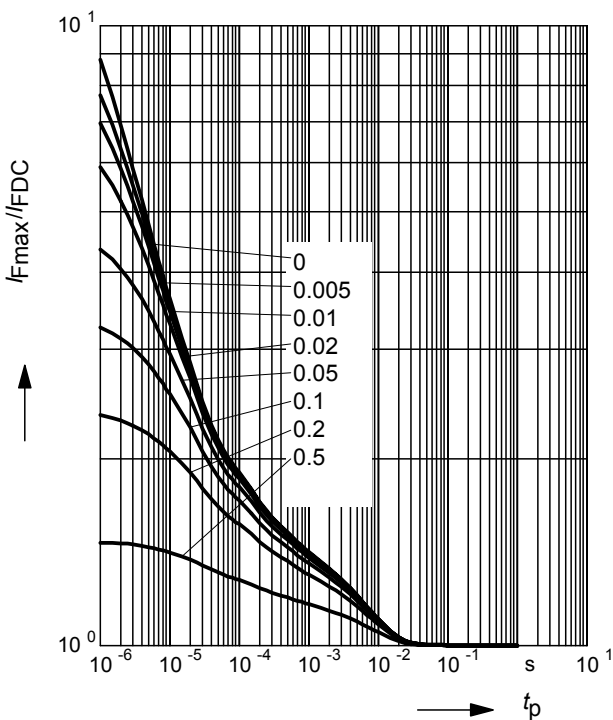

Permissible Pulse Load $R_{thJS} = f(t_p)$

BAR50-03W

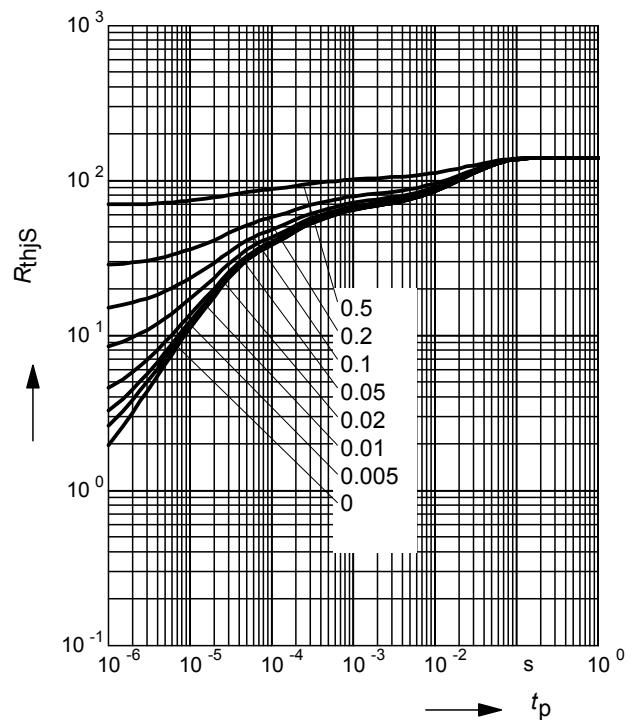

Permissible Pulse Load

$$I_{Fmax} / I_{FDC} = f(t_p)$$

BAR50-03W

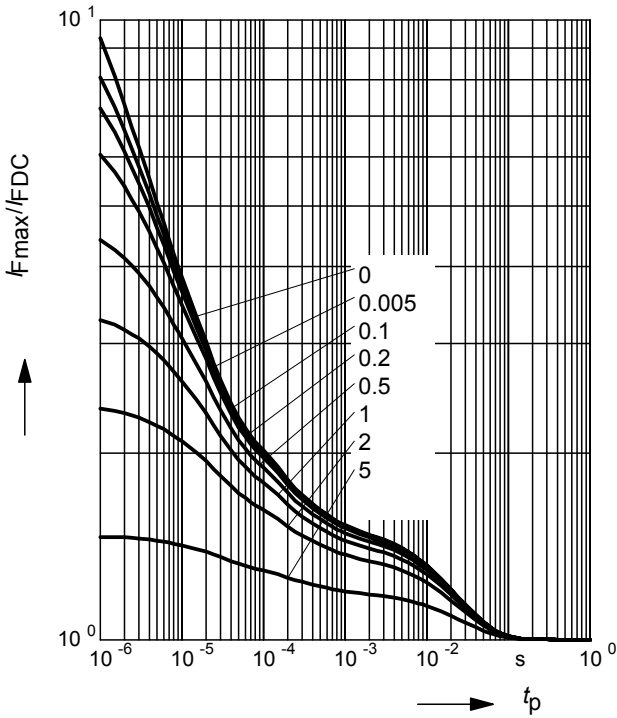

Insertion loss $I_L = -|S_{21}|^2 = f(f)$

I_F = Parameter

BAR50-02L in series configuration, $Z = 50\Omega$

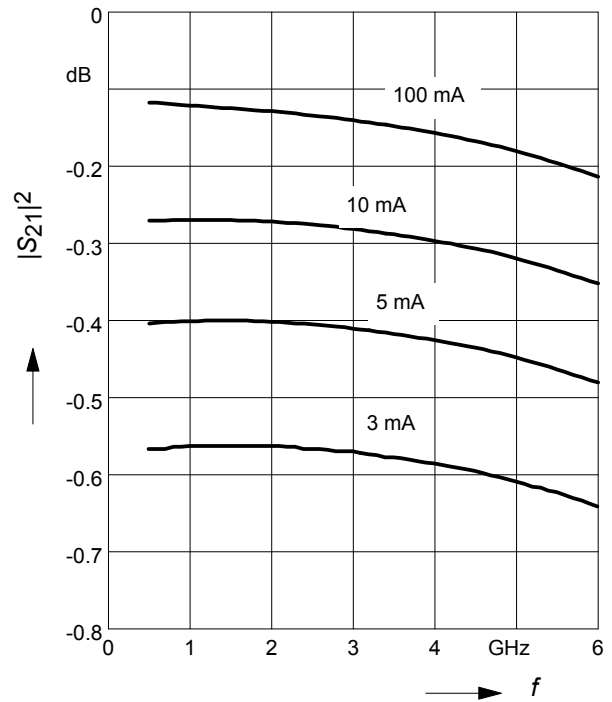

Isolation $I_{SO} = -|S_{21}|^2 = f(f)$

V_R = Parameter

BAR50-02L in series configuration, $Z = 50\Omega$

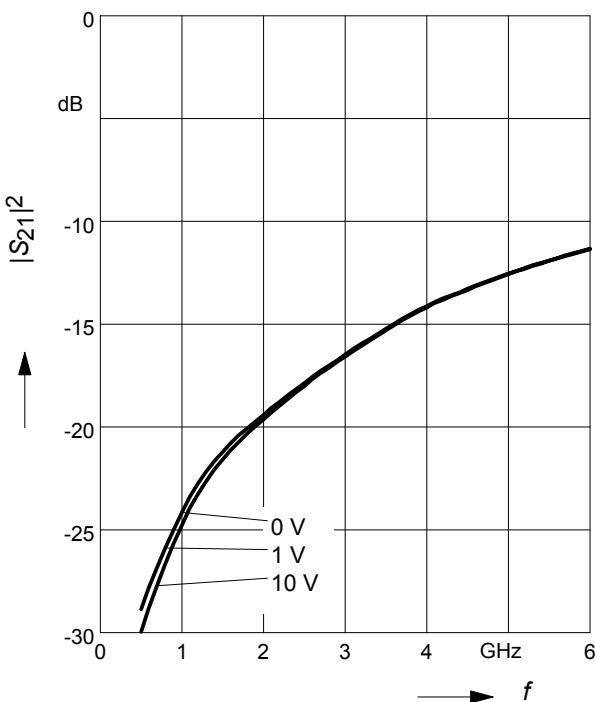

Package Outline



Foot Print

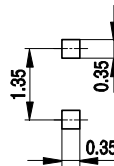

Marking Layout (Example)

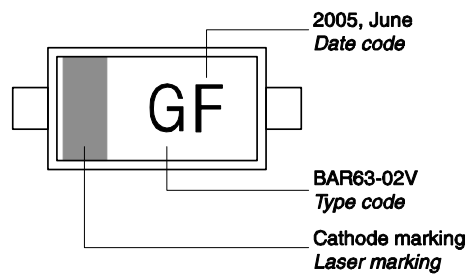

Standard Packing

Reel ø180 mm = 3.000 Pieces/Reel
 Reel ø180 mm = 8.000 Pieces/Reel (2 mm Pitch)
 Reel ø330 mm = 10.000 Pieces/Reel

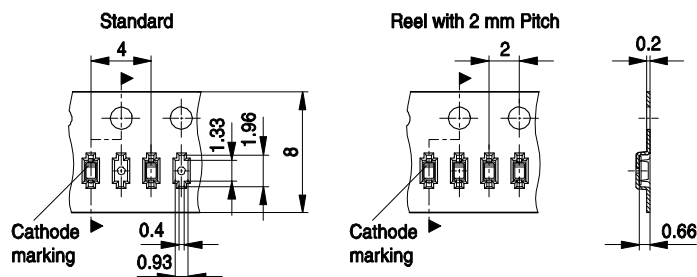

Date Code marking for discrete packages with one digit (SCD80, SC79, SC75¹⁾) CES-Code

Month	2003	2004	2005	2006	2007	2008	2009	2010	2011	2012	2013	2014
01	a	p	A	P	a	p	A	P	a	p	A	P
02	b	q	B	Q	b	q	B	Q	b	q	B	Q
03	c	r	C	R	c	r	C	R	c	r	C	R
04	d	s	D	S	d	s	D	S	d	s	D	S
05	e	t	E	T	e	t	E	T	e	t	E	T
06	f	u	F	U	f	u	F	U	f	u	F	U
07	g	v	G	V	g	v	G	V	g	v	G	V
08	h	x	H	X	h	x	H	X	h	x	H	X
09	j	y	J	Y	j	y	J	Y	j	y	J	Y
10	k	z	K	Z	k	z	K	Z	k	z	K	Z
11	l	2	L	4	l	2	L	4	l	2	L	4
12	n	3	N	5	n	3	N	5	n	3	N	5

1) New Marking Layout for SC75, implemented at October 2005.

Package Outline

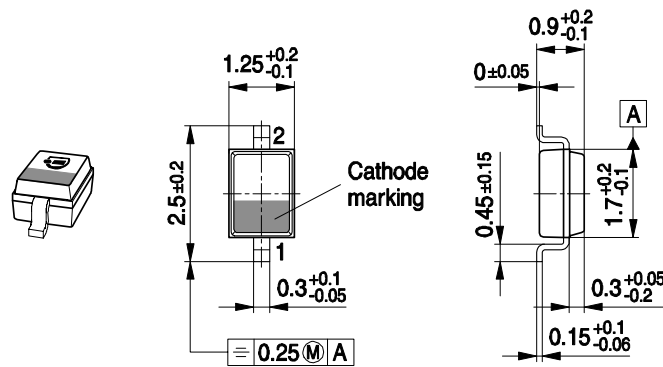

Foot Print

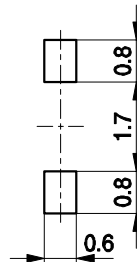

Marking Layout (Example)

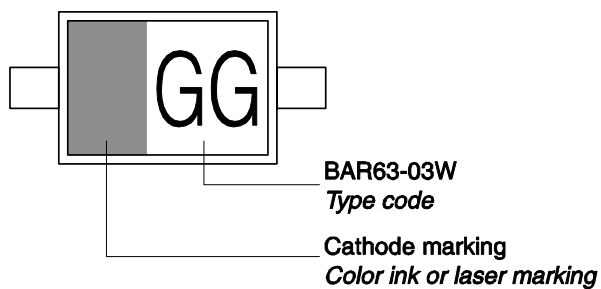

Standard Packing

Reel ø180 mm = 3.000 Pieces/Reel
 Reel ø330 mm = 10.000 Pieces/Reel

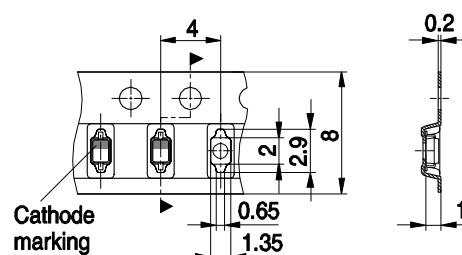

Package Outline

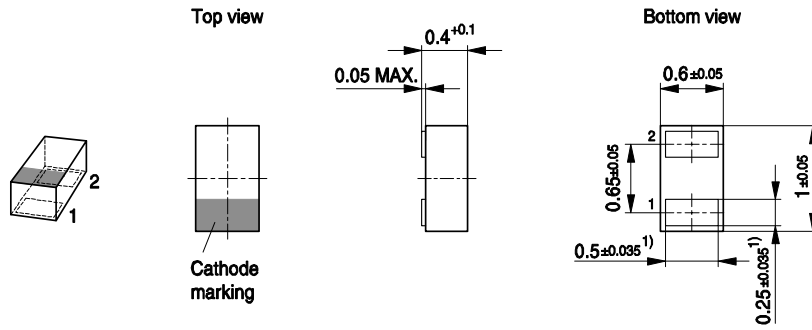

1) Dimension applies to plated terminal

Foot Print

For board assembly information please refer to Infineon website "Packages"

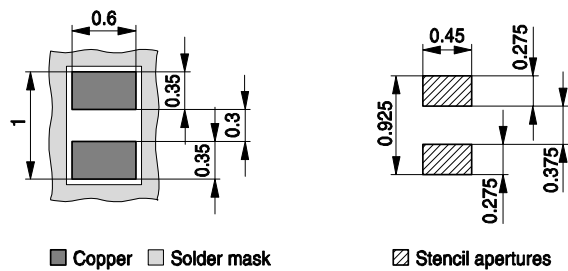

Marking Layout (Example)

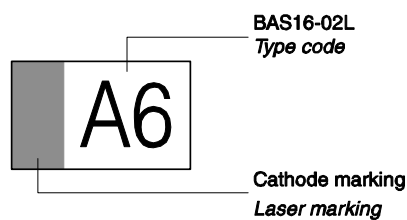

Standard Packing

Reel \varnothing 180 mm = 15.000 Pieces/Reel
 Reel \varnothing 330 mm = 50.000 Pieces/Reel (optional)

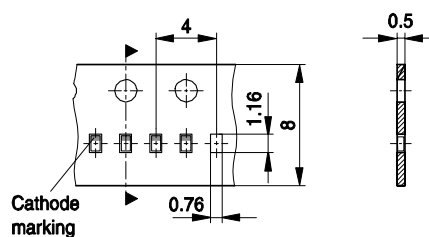

Edition 2009-11-16

**Published by
Infineon Technologies AG
81726 Munich, Germany**

**© 2009 Infineon Technologies AG
All Rights Reserved.**

Legal Disclaimer

The information given in this document shall in no event be regarded as a guarantee of conditions or characteristics. With respect to any examples or hints given herein, any typical values stated herein and/or any information regarding the application of the device, Infineon Technologies hereby disclaims any and all warranties and liabilities of any kind, including without limitation, warranties of non-infringement of intellectual property rights of any third party.

Information

For further information on technology, delivery terms and conditions and prices, please contact the nearest Infineon Technologies Office (www.infineon.com).

Warnings

Due to technical requirements, components may contain dangerous substances. For information on the types in question, please contact the nearest Infineon Technologies Office.

Infineon Technologies components may be used in life-support devices or systems only with the express written approval of Infineon Technologies, if a failure of such components can reasonably be expected to cause the failure of that life-support device or system or to affect the safety or effectiveness of that device or system. Life support devices or systems are intended to be implanted in the human body or to support and/or maintain and sustain and/or protect human life. If they fail, it is reasonable to assume that the health of the user or other persons may be endangered.