

## Top view LEDs 67-22/R6BHC-B07/2T



### Features

- P-LCC-4 package
- Optical indicator
- Colorless clear window
- Ideal for backlight and light pipe application
- Inter reflector
- Wide viewing angle
- Suitable for vapor-phase reflow.
- Computable with automatic placement equipment
- Available on tape and reel (8mm Tape)
- Pb-free
- The product itself will remain within RoHS compliant version

### Applications

- Telecommunication: indicator and backlighting in telephone and fax
- Flat backlight for LCD's, switches and symbols
- Light pipe application
- General use

## Device Selection Guide

| Chip Materials | Emitted Color            | Resin Color |
|----------------|--------------------------|-------------|
| R6             | AlGaInP<br>Brilliant Red | Water clear |
| BH             | InGaN<br>Blue            | Water clear |

## Absolute Maximum Ratings (Ta=25°C)

| Parameter             | Symbol    | Rating                                | Unit |
|-----------------------|-----------|---------------------------------------|------|
| Reverse Voltage       | $V_R$     | 5                                     | V    |
| Forward Current       | $I_F$     | R6 50                                 | mA   |
|                       |           | BH 25                                 |      |
| Peak Forward Current  | $I_{FP}$  | R6 100                                | mA   |
|                       |           | BH 100                                |      |
| Power Dissipation     | $P_d$     | R6 120                                | mW   |
|                       |           | BH 95                                 |      |
| Operating Temperature | $T_{opr}$ | -40 ~ +85                             | °C   |
| Storage Temperature   | $T_{stg}$ | -40 ~ +90                             | °C   |
| Soldering Temperature | $T_{sol}$ | Reflow Soldering : 260 °C for 10 sec. |      |
|                       |           | Hand Soldering : 350 °C for 3 sec.    |      |

**Electro-Optical Characteristics (Ta=25°C)**

| Parameter                    | Symbol         | Min.  | Typ.  | Max.  | Unit  | Condition            |    |
|------------------------------|----------------|-------|-------|-------|-------|----------------------|----|
| Luminous Intensity           | I <sub>v</sub> | R6    | 90    | ----- | 225   | mcd                  |    |
|                              |                | BH    | 90    | ----- | 225   |                      |    |
| Viewing Angle                | 2θ1/2          | ----- | 120   | ----- | deg   | I <sub>F</sub> =20mA |    |
| Peak Wavelength              | λ <sub>p</sub> | R6    | ----- | 632   | ----- |                      | nm |
|                              |                | BH    | ----- | 468   | ----- |                      |    |
| Dominant Wavelength          | λ <sub>d</sub> | R6    | 621   | ----- | 631   |                      | nm |
|                              |                | BH    | 466.5 | ----- | 471.5 |                      |    |
| Spectrum Radiation Bandwidth | Δλ             | R6    | ----- | 20    | ----- |                      | nm |
|                              |                | BH    | ----- | 25    | ----- |                      |    |
| Forward Voltage              | V <sub>F</sub> | R6    | 1.75  | ----- | 2.35  | V                    |    |
|                              |                | BH    | 2.9   | ----- | 3.7   |                      |    |
| Reverse Current              | I <sub>R</sub> | ----- | ----- | 10    | μA    | V <sub>R</sub> =5V   |    |

Note:

1. Tolerance of Luminous Intensity: ±11%
2. Tolerance of Dominant Wavelength: ±1nm
3. Tolerance of Forward Voltage: ±0.1V

### Bin Range of Luminous Intensity

| Symbol | Bin Code | Min. | Max. | Unit | Condition         |
|--------|----------|------|------|------|-------------------|
| R6     | Q2       | 90   | 112  | mcd  | $I_F=20\text{mA}$ |
|        | R1       | 112  | 140  |      |                   |
|        | R2       | 140  | 180  |      |                   |
|        | S1       | 180  | 225  |      |                   |
| BH     | Q2       | 90   | 112  |      |                   |
|        | R1       | 112  | 140  |      |                   |
|        | R2       | 140  | 180  |      |                   |
|        | S1       | 180  | 225  |      |                   |

### Bin Range of Dominant Wavelength

| Symbol | Bin Code | Min.  | Max.  | Unit | Condition         |
|--------|----------|-------|-------|------|-------------------|
| R6     | FF1      | 621   | 626   | nm   | $I_F=20\text{mA}$ |
|        | FF2      | 626   | 631   |      |                   |
| BH     | ----     | 466.5 | 471.5 |      |                   |

### Bin Range of Forward Voltage

| Chip | Bin Code | Min. | Max. | Unit | Condition         |
|------|----------|------|------|------|-------------------|
| R6   | 0        | 1.75 | 1.95 | V    | $I_F=20\text{mA}$ |
|      | 1        | 1.95 | 2.15 |      |                   |
|      | 2        | 2.15 | 2.35 |      |                   |
| BH   | 11       | 2.90 | 3.10 |      |                   |
|      | 12       | 3.10 | 3.30 |      |                   |
|      | 13       | 3.30 | 3.50 |      |                   |
|      | 14       | 3.50 | 3.70 |      |                   |

1. Tolerance of Luminous Intensity:  $\pm 11\%$
2. Tolerance of Dominant Wavelength:  $\pm 1\text{nm}$
3. Tolerance of Forward Voltage:  $\pm 0.1\text{V}$

### Typical Electro-Optical Characteristics Curve (R6)

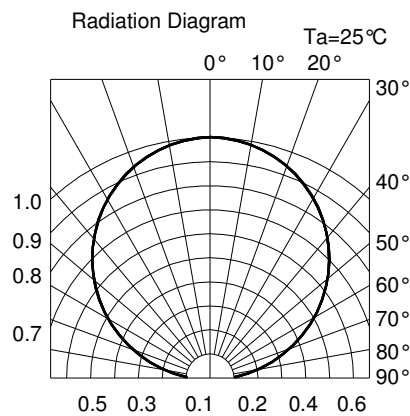
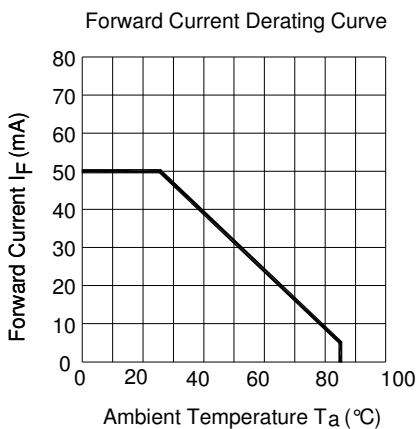
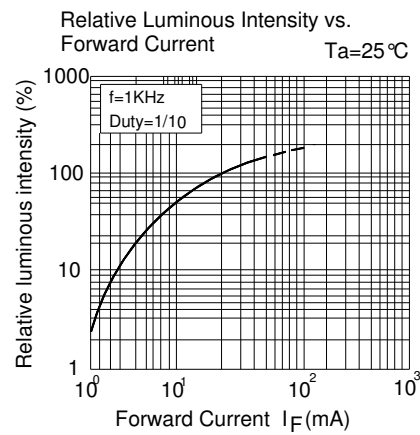
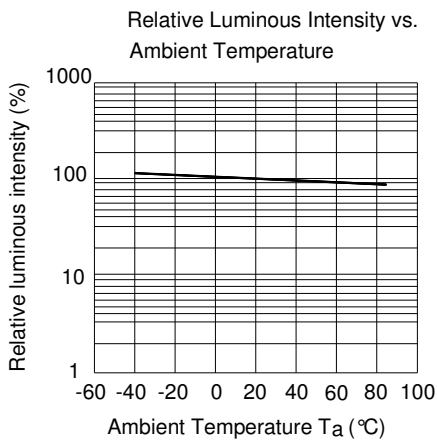
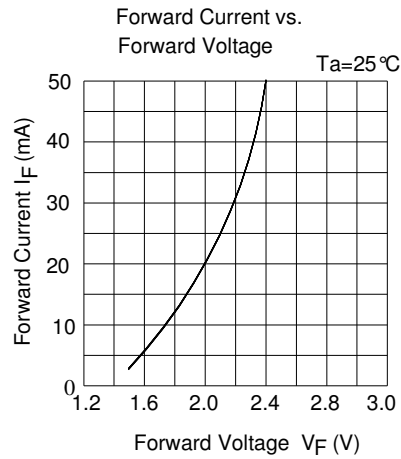
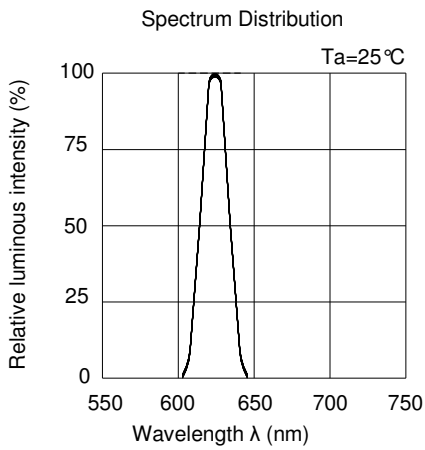

### Typical Electro-Optical Characteristics Curves (BH)

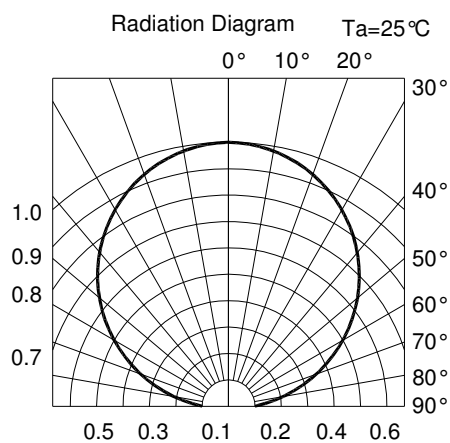
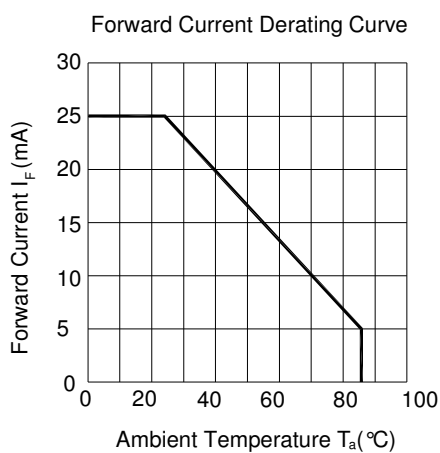
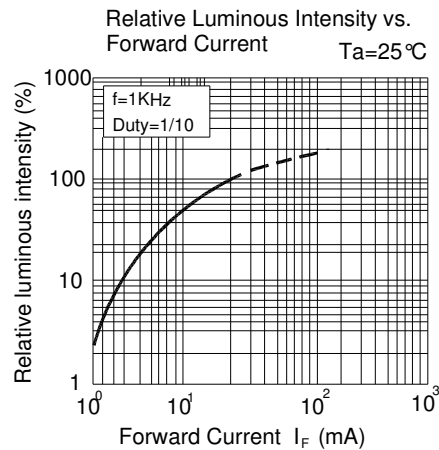
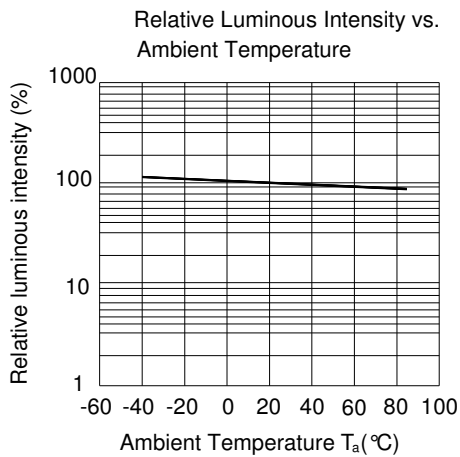
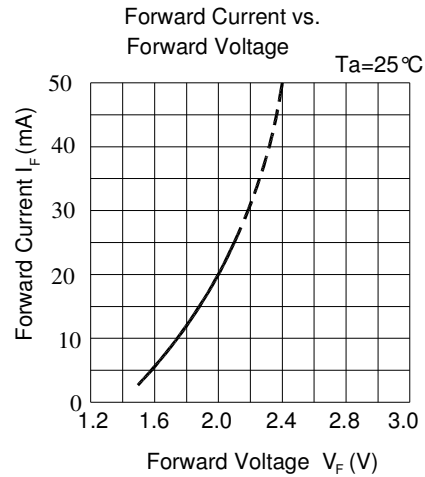
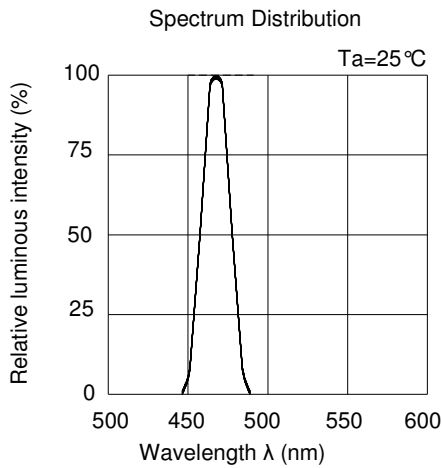

Package Dimension

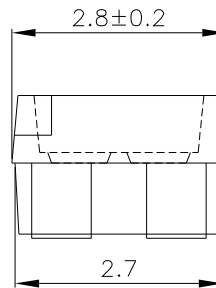
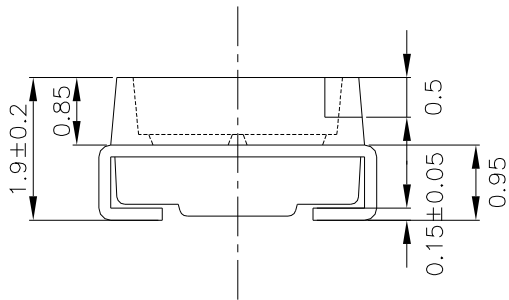
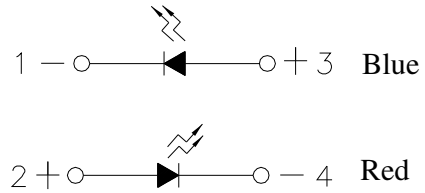
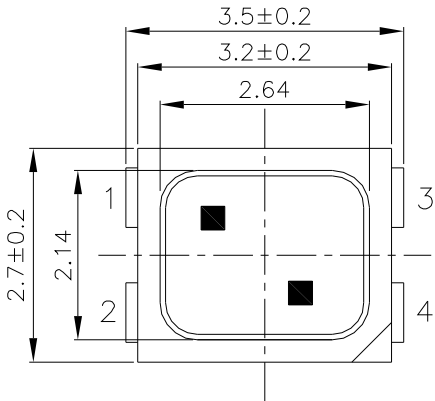

Recommended Solder Pad

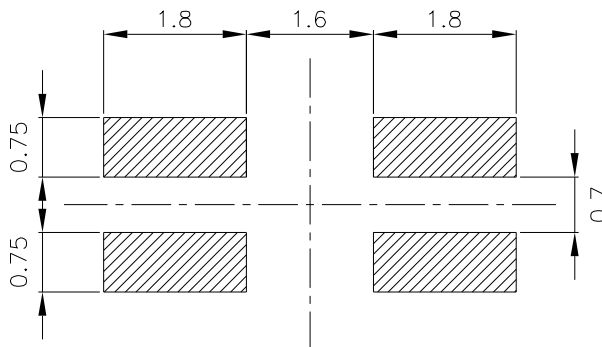
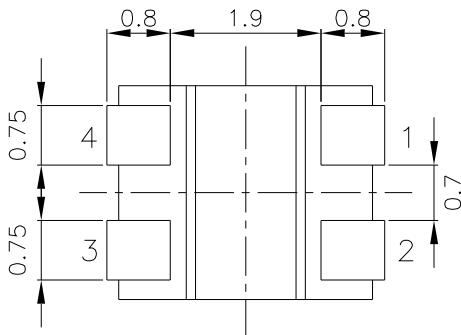

Note: Tolerances unless mentioned  $\pm 0.1$ mm. Unit = mm

## Moisture Resistant Packing Materials

### Label Explanation



- CPN: Customer's Product Number
- P/N: Product Number
- QTY: Packing Quantity
- CAT: Luminous Intensity Rank
- HUE: Dom. Wavelength Rank
- REF: Forward Voltage Rank
- LOT No: Lot Number

### Reel Dimensions

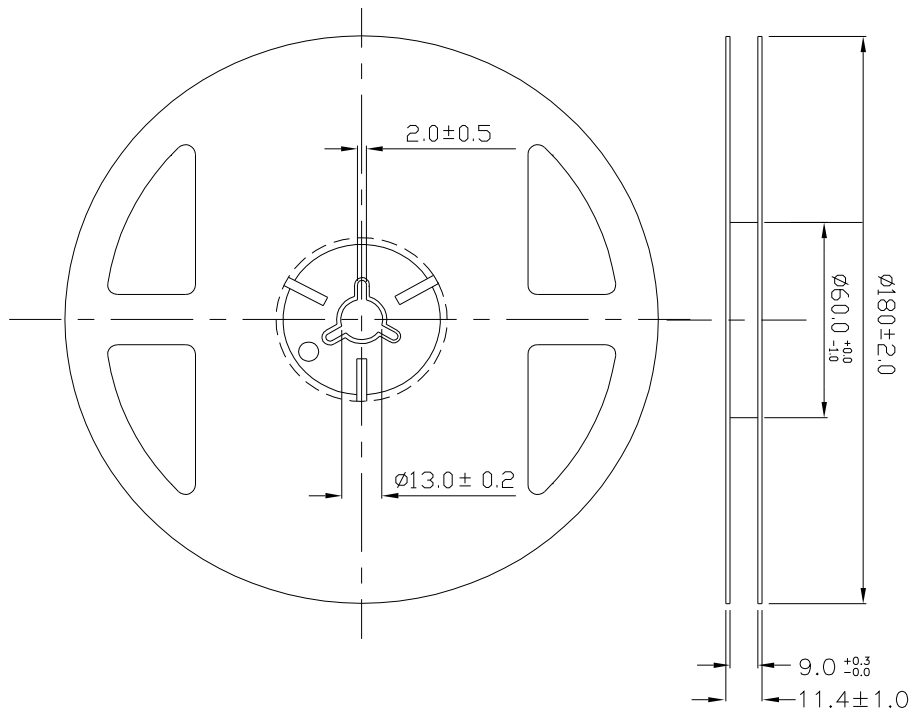



**Carrier Tape Dimensions: Loaded Quantity 2000 pcs Per Reel**

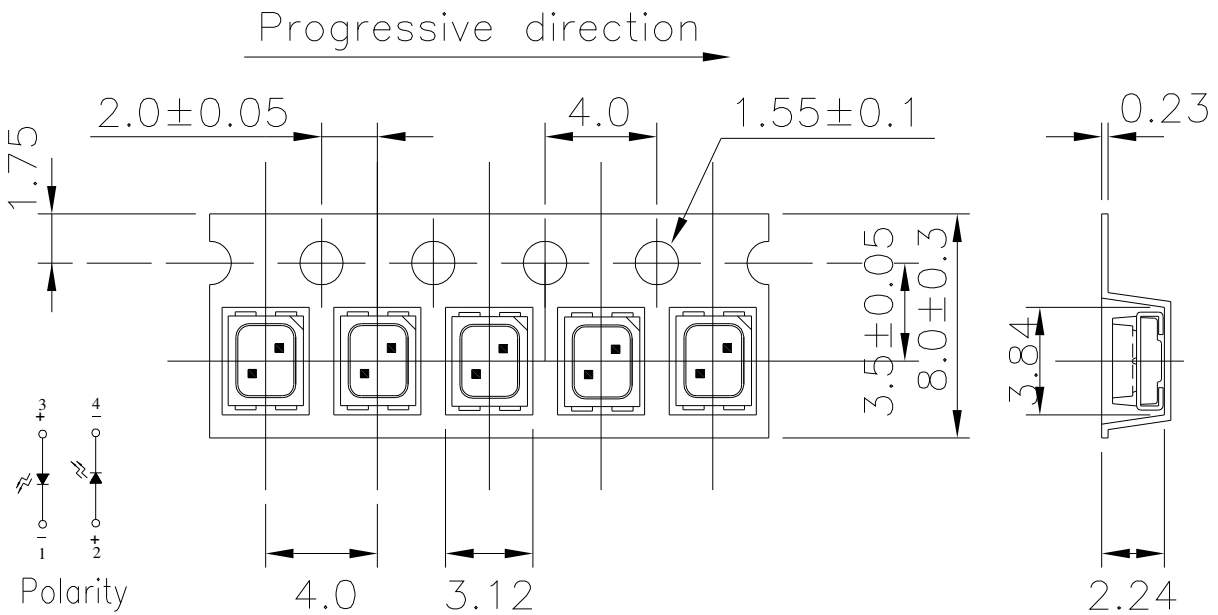

Note: Tolerances unless mentioned  $\pm 0.1$ mm. Unit = mm

**Moisture Resistant Packing Process**

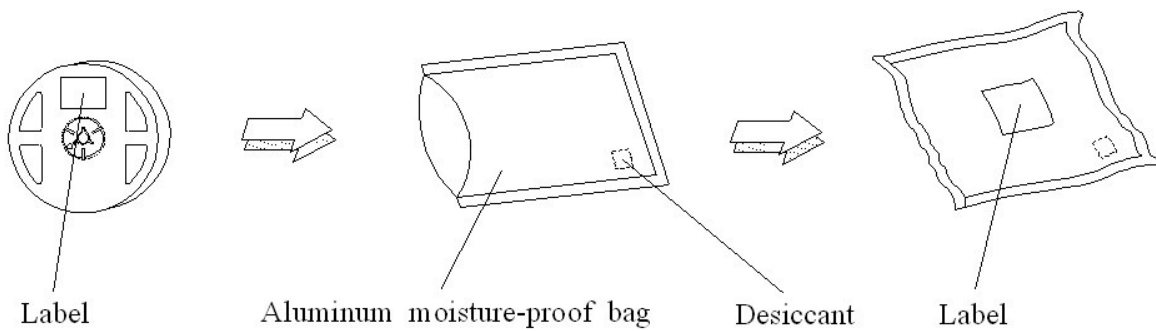

Note: Tolerances unless mentioned  $\pm 0.1$ mm. Unit = mm

## Precautions for Use

### 1. Over-current-proof

Customer must apply resistors for protection , otherwise slight voltage shift will cause big current change ( Burn out will happen ).

### 2. Storage

2.1 Do not open moisture proof bag before the products are ready to use.

2.2 Before opening the package, the LEDs should be kept at 30°C or less and 90%RH or less.

2.3 After opening the package: The LED's floor life are 168 hours under 30°C or less and 60% RH or less.

If unused LEDs remain, it should be stored in moisture proof packages.

2.4 If the moisture absorbent material (silica gel) has faded away or the LEDs have exceeded the storage time, baking treatment should be performed using the following conditions.

Baking treatment : 60±5°C for 24 hours.

### 3. Soldering Condition

#### 3.1 Pb-free solder temperature profile

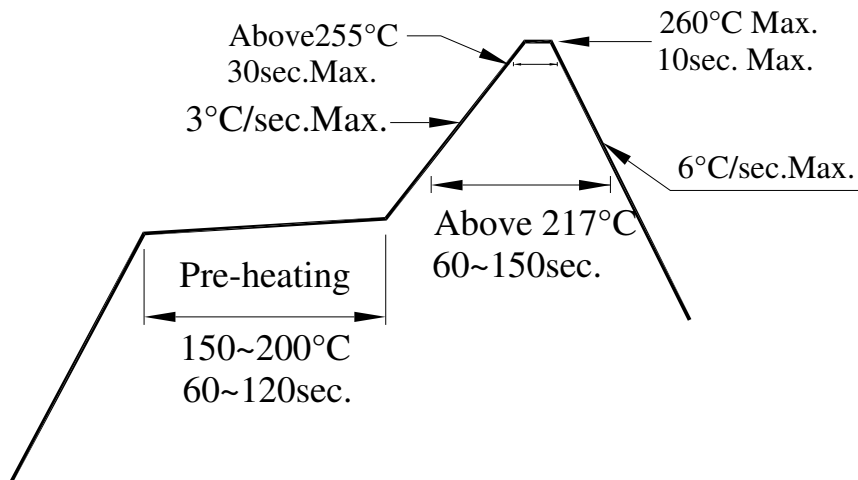

3.2 Reflow soldering should not be done more than two times.

3.3 When soldering, do not put stress on the LEDs during heating.

3.4 After soldering, do not warp the circuit board.

#### 4. Soldering Iron

Each terminal is to go to the tip of soldering iron temperature less than  $350^{\circ}\text{C}$  for 3 seconds within once in less than the soldering iron capacity 25W. Leave two seconds and more intervals, and do soldering of each terminal. Be careful because the damage of the product is often started at the time of the hand solder.

#### 5. Repairing

Repair should not be done after the LEDs have been soldered. When repairing is unavoidable, a double-head soldering iron should be used (as below figure). It should be confirmed beforehand whether the characteristics of the LEDs will or will not be damaged by repairing.

