

PLEASE CHECK WWW.MOLEX.COM FOR LATEST PART INFORMATION

Part Number: [39880-1208](#)
Status: **Active**
Overview: Eurostyle™ Terminal Blocks
Description: 5.08mm Pitch Horizontal Fixed Mount PCB Terminal Block, 8 Circuits

Documents:

[3D Model](#) [RoHS Certificate of Compliance \(PDF\)](#)
[Drawing \(PDF\)](#)

Agency Certification

CSA LR25562
 UL E48521

General

Product Family Terminal Blocks
 Series [39880](#)
 Application N/A
 Component Type One Piece
 Overview [Eurostyle™ Terminal Blocks](#)
 Product Name Eurostyle™ Fixed Mount
 Type Euro Block
 UPC 800756723839

Physical

Circuits (Loaded) 8
 Circuits (maximum) 8
 Entry Angle 90° Angle
 Flammability 94V-0
 Lock to Mating Part None
 Number of Rows 1
 Orientation Horizontal
 PC Tail Length 3.60mm
 PCB Retention None
 PCB Thickness - Recommended 1.57mm
 Panel Mount No
 Pitch - Mating Interface 5.08mm
 Pitch - Termination Interface 5.08mm
 Polarized to Mating Part Yes
 Shrouded Fully
 Stackable No
 Surface Mount Compatible (SMC) No
 Temperature Range - Operating -40°C to +105°C
 Wire Size AWG 12, 14, 16, 18, 20, 22, 24, 26, 28, 30

Electrical

Current - Maximum per Contact 17.5A
 Voltage - Maximum 300V

Material Info

Reference - Drawing Numbers

Sales Drawing SD-39880-011

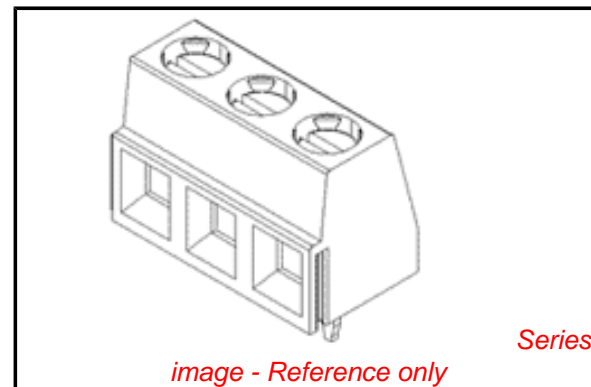

EU RoHS

**ELV and RoHS
 Compliant**
**REACH SVHC
 Not Reviewed**
**Low-Halogen Status
 Not Reviewed**

China RoHS



**Need more information on product
 environmental compliance?**

Email productcompliance@molex.com
 For a multiple part number RoHS Certificate of
 Compliance, [click here](#)

Please visit the [Contact Us](#) section for any
 non-product compliance questions.

Search Parts in this Series

[39880Series](#)