





PAD	CONNECTION
1	Control voltage
2	Ground
3	Output
4	Supply

Scale 3:1

## Features

-  **5.0V supply**
-  **Fundamental mode crystal up to 50.0MHz**
-  **Choice of pullability & stability**
-  **Miniature SM package**

## Specifications

Parameters	Product	Option Codes
	GVXO-525	
<b>Frequency range:</b> 2.0 ~ 50.0MHz	■	
<b>Voltage control:</b> +2.5V ±2.0V, 10% linearity	■	
<b>Frequency pullability (min):</b> ±100ppm (<30MHz only) ±80ppm ±50ppm Other	■ ■ □ □	S P N specify
<b>Frequency stability:</b> ±50ppm ±25ppm Other	■ □ □	B C specify
<b>Operating temperature range:</b> -20 to +70°C -40 to +85°C	■ □	I
<b>Storage temperature range:</b> -40 to +85°C	■	
<b>Supply voltage (V<sub>DD</sub>):</b> +5.0V (±5%)	■	
<b>Supply current:</b> 15mA max (2.0 ~ 20.0MHz) 20mA max (>20.0 ~ 30.0MHz) 25mA max (>30.0 ~ 40.0MHz) 30mA max (>40.0MHz)	■ ■ ■ ■	
<b>Driving ability:</b> 15pF CMOS	■	
<b>Logic levels:</b> '0' level = 10%V <sub>DD</sub> max '1' level = 90%V <sub>DD</sub> min	■ ■	
<b>Waveform symmetry:</b> 45:55 max @ 50%V <sub>DD</sub>	■	
<b>Rise / fall time:</b> 10ns max (10%~90%V <sub>DD</sub> )	■	
<b>Start up time:</b> 10ms max	■	
<b>Period jitter RMS:</b> 6 ps max	■	
<b>Phase jitter RMS:</b> 1ps max, 12kHz ~ 20MHz	■	
<b>Phase noise (typ):</b> -130dBc/Hz @ 1kHz	■	
<b>Ageing:</b> ±5ppm / year max	■	

■ Standard. □ Optional - Please specify required code(s) when ordering

## Ordering Information

Product + option codes + frequency

eg: **GVXO-525/SC 27.0MHz** ±100ppm pull, ±25ppm stab, -10+70°C

**GVXO-525/PBI 35.3280MHz** ±80ppm pull, ±50ppm stab, -40+85°C

Option codes must be included to specify a model completely.

Option code X (eg GVXO-525/X) denotes a custom spec.

◆ Please check availability of ±25ppm stability over -40+85°C before ordering

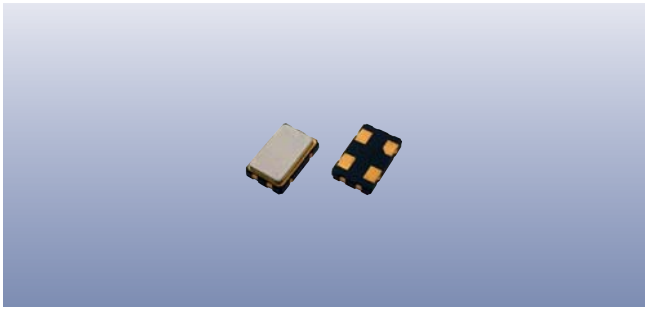

## Construction

- ▬▬▬▬ **Ceramic body with gold-plated pads**
- ▬▬▬▬ **Metal lid, seam sealed**

## Composition



This product is lead-free, and is fully compliant with the RoHS directive 2002/95/EC



## Packaging & Handling

Production quantities supplied on T & R, 1k pcs per reel.  
Small quantities may be supplied on tape (no reel), or in bulk.



◆ Static sensitive product. Observe proper handling precautions

## Marking

- Pin 1
- Marking type: Laser
- DC = Date code in YM, eg "CE" = May 2003

FREQUENCY	
• PARTNO DC	

	A	B	C	D	E	F	G	H	J	K	L	M
Y	1	2	3	4	5	6	7	8	9	0		
M	Jan	Feb	Mar	Apr	May	Jun	Jul	Aug	Sep	Oct	Nov	Dec

## Tape & Reel Specification

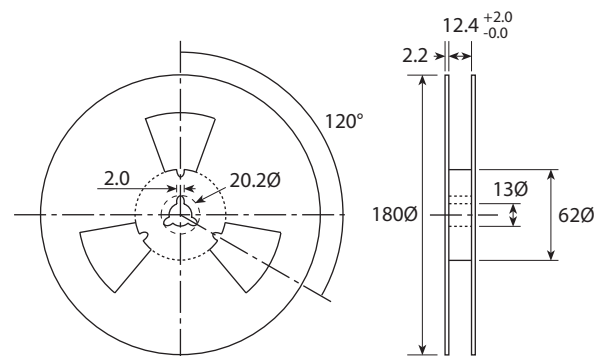
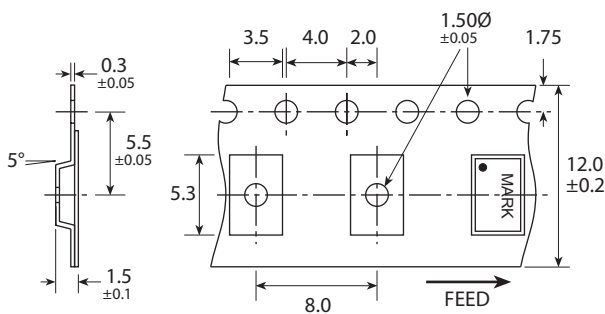

Not to scale. Dimensions in mm. Tolerances ±0.1mm unless otherwise stated

## Soldering Profile

