

1. 安全认证:
Safety Standard:
C-UL TUV CQC
2. 接点规格:
Contact Specification:
2.1 接点间隙:

Contact Gap:

最小 0.3 mm。

0.3mm Minimum.

2.2 接点阻抗:

Contact Resistance

初始值最大 100mΩ;

流通电流 1A、开路测试电压: 6VDC;

使用电压下降法量测。

Maximum 100mΩ at initial value.

Test Current: 1A, Open Circuit Test Voltage: 6VDC.

By using Voltage Drop Method.

2.3 接点容量:

Contact Capacity:

HK115FD

250VAC Cos φ=1, 可通过电流为 8 安培。

30VDC , 可通过电流为 8 安培。

8Amps at 250VAC Cos φ=1.

8 Amps at 30VDC

HK115FH

250VAC Cos φ=1, 可通过电流为 16 安培。

30VDC , 可通过电流为 16 安培。

16Amps at 250VAC Cos φ=1.

16 Amps at 30VDC

HK115F

250VAC Cos φ=1, 可通过电流为 12 安培。

30VDC , 可通过电流为 12 安培。

12Amps at 250VAC Cos φ=1.

12 Amps at 30VDC

3. 摄氏 20 度之线圈规格:
Coil Specification at 20 °C:
3.1 额定电压:

Rated Voltage:

5VDC 6VDC 12VDC 24VDC 48VDC 60VDC 110VDC

3.2 额定电流:(± 10%)

Nominal Current:

80mA 66mA 33mA 16.7mA 8.3mA 8mA 3.7mA

3.3 额定消耗功率:(± 10%.)

Rated Power Consumption:

0.4W

3.4 线圈阻抗:(± 10%.)

Coil Resistance:

62.5 90 360 1440 5760 7500 30000

3.5 感动电压:

Pull In Voltage:

 ≧ (当电压渐渐施加于继电器时接点之动作电压, 为额定电压之 75%)
V DC

 ≧ (Contact operating voltage when voltage is gradually applied. It is
75% of the Rated Voltage) V DC

- 3.6 开放电压: \cong (当额定电压渐渐的减少时接点放开之电压, 为额定电压之 10%) VDC
Drop Out Voltage: \cong (Contact breaking voltage when rated voltage is gradually reduced. It is 10% of the Rated Voltage) VDC
- 3.7 最大应加电压: (为额定电压之 150%) V DC
Max. Allowable Voltage: (150% of the Rated Voltage) V DC
- 3.8 动作时间: 在施加额定电压时最大为 15milliseconds。
Operate Time: 15milliseconds Maximum when rated Voltage is applied.
- 3.9 开放时间: 在额定电压突然消失时最大为 8 milliseconds。
Release Time: 8milliseconds Maximum when rated Voltage is suddenly cut off.
- 3.10 线圈温升: 在空载时线圈施加最大可允许电压, 待温度稳定后量测的温度不可超过
Coil Temperature Rise: 40°C。(不包含环境温度)
40°C Maximum.
Maximum Allowable Voltage is applied to Coil while no load should be applied to Contacts, then the temperature should be measured when the value is stabilized. Environment temperature should not be included in.

4. 电气特性:

Electrical Characteristics:

4.1 使用寿命:

Life Expectancy:

4.1.1 电气寿命:

Electrical Life:

HK115FD

8A/250VAC Cos ϕ =1, 施加额定电压时, 有 100,000 次以上之电气寿命。

8A/30VDC, 施加额定电压时, 有 100,000 次以上之电气寿命。

100,000 operations Minimum at 8A/250VAC Cos ϕ =1.

100,000 operations Minimum at 8A/30VDC

Rated Voltage is applied.

HK115FH

16A/250VAC Cos ϕ =1, 施加额定电压时, 有 100,000 次以上之电气寿命。

16A/30VDC, 施加额定电压时, 有 100,000 次以上之电气寿命。

100,000 operations Minimum at 16A/250VAC Cos ϕ =1.

100,000 operations Minimum at 16A/30VDC

Rated Voltage is applied.

HK115FD

12A/250VAC Cos ϕ =1, 施加额定电压时, 有 100,000 次以上之电气寿命。

12A/30VDC, 施加额定电压时, 有 100,000 次以上之电气寿命。

100,000 operations Minimum at 12A/250VAC Cos ϕ =1.

100,000 operations Minimum at 12A/30VDC

Rated Voltage is applied.

4.1.2 机械寿命:

Mechanical Life:

在无负载的情况下有 10,000,000 次以上之机械寿命。

10,000,000 operations Minimum at No Load condition.

- 4.1.3 最大操作频率
Maximum Operating Frequency: 电气: 每分钟 30 次。
机械: 每分钟 300 次。
Electrical: 30 operations/minute.
Mechanical: 300 operations/minute.
- 4.2 介质耐压:
Dielectric Strength:
- 4.2.1 接点对接点间:
Between Contacts: 1000VAC, 50/60 Hz, 漏电流小于 1mA, 持续一分钟。
1000VAC at Test Frequency 50/60 Hz, Leakage Current: 1mA for 1 minute.
- 4.2.2 线圈对接点间:
Between Coil & Contact: 5000VAC, 50/60 Hz, 漏电流小于 1mA, 持续一分钟。
5000VAC at Test Frequency 50/60 Hz, Leakage Current: 1mA for 1 minute.
- 4.3 绝缘阻抗:
Insulation Resistance: 在施加 500VDC 绝缘阻抗之量测值需 $\geq 100 \text{ M}\Omega$ 。
 $\geq 100 \text{ M}\Omega$ Minimum.
A Voltage of 500VDC should be applied after which measurement shall be made.
- 4.4 振动测试:
Vibration
- 4.4.1 振动 I (强度):
Endurance I: 在无激磁状态下双振幅宽度为 1.5mm, 震动频率在一分钟内由 10HZ~55HZ~10HZ。XYZ 各方向各进行 2 小时, 共六小时, 实验后外观构造不可异常, 且电气功能需符合规格之要求。
The Coil shall be maintained under not energized condition, double amplitude 1.5 mm, the entire frequency range changes from 10 to 55 Hz then returns to 10 Hz shall be made in 1 minute. This motion shall be applied for a period of 2 hours in each of 3 mutually perpendicular axis (a total of 6 hours) There should not be any deformations in construction and in appearance, while the Electrical Specifications should be fulfilled after the test.
- 4.4.2 振动 II (稳定性):
Endurance II (Error Operation): 在激磁状态下双振幅宽度是 1.5mm, 震动频率在一分钟内由 10HZ~55HZ~10HZ。XYZ 各方向进行 5 分钟, 实验中不得有误(接点断开时间不可超过 1 mS)。实验后外观, 构造不可异常, 且电气功能需符合规格之要求。
The Coil shall be maintained under energized condition, double amplitude 1.5 mm, the entire frequency range changes from 10 to 55 Hz then returns to 10 Hz shall be made in 1 minute. This motion shall be applied for a period of 5 minutes in 3 mutually perpendicular axis. Malfunction is not allowed during the test (contact breaking time should be less than 1 millisecond) In addition, there should not be any deformations in construction and in appearance while the Electrical Specifications should be fulfilled after the test.

4.5 冲击测试:

Shock:

4.5.1 耐冲击性 I (强度):
Endurance I:

在无激磁状态加速度 1000m/s^2 冲击情况下, XYZ 各方向进行 5 次, 实验后外观, 构造不可异常, 且电气功能需符合规格之要求。

Peak Acceleration: 1000m/s^2

The Coil shall be maintained under not energized condition, 5 successive shocks shall be applied in 3 mutually perpendicular axis. There should not be any deformations in construction and in appearance while the Electrical Specifications should be fulfilled after the test.

4.5.2 耐冲击性 II (稳定性):
Endurance II (Error Operation):

在激磁状态加速度 100m/s^2 冲击情况下, XYZ 各方向进行 2 次, 实验中不得有误(接点断开时间不可超过 1 mS), 实验后外观, 构造不可异常, 且电气功能需符合规格之要求。

Peak Acceleration: 100m/s^2

The Coil should be maintained under energized condition, 2 successive shocks shall be applied in 3 mutually perpendicular axis. Malfunction is not allowed during the test (contact breaking time should be less than 1 millisecond) In addition, there should not be any deformations in construction and in appearance while the Electrical Specifications should be fulfilled after the test.

5. 环境特性:

Environmental
Characteristics:

5.1 温度范围:

Temperature Range:

5.1.1 使用温度范围:

Operating

Temperature Range:

-40 to + 70°C.

使用温度范围是代表继电器在线圈之动作电压范围内可以持续动作的温度范围(在低温时无水滴凝结现象)

Operating temperature range is the range of ambient temperature of which the Relay can be operated continuously within operative voltage range of coil (no condensation of water drops under low temperature condition)

5.1.2 储存温度范围:

Storage Temperature
Range:

-30 to + 70°C.

储存温度范围是代表继电器在没有损伤的情况下可以被储存的温度范围(在低温时无水滴凝结现象)。储存的情况在本 SPEC 其它地方所示。

Storage temperature range is the range of ambient temperature of which the Relay can be stored without damages (no condensation of water drops under low temperature condition). Conditions are as specified elsewhere in these specifications.

5.2 湿度范围:

Humidity Range:

35~85% RH.

5.3 耐寒性:

Cold Resistance:

5.3.1 使用耐寒性:
Cold Resistance in
Use:

继电器不给予电压或电流状态下, 在恒温箱以 $-40 \pm 2^{\circ}\text{C}$ 的温度连续保持 2 小时。保持原状态操作回路上给予定格电压实验时继电器动作要正常。(在低温时无水滴凝结现象)

Relay should be kept in temperature chamber at $-40 \pm 2^{\circ}\text{C}$ for two hours that no current or voltage shall be supplied to Relay. Such condition shall be maintained while the rated voltage is supplied to Relay, then the Relay shall operate normally. (No condensation of water drops under low temperature condition)

5.3.2 储存耐寒性:
Storage Cold
Resistance:

继电器在恒温箱以 $-30 \pm 2^{\circ}\text{C}$ 的温度连续保持 72 小时。接着, 于常温常湿中消除水滴 1 至 2 小时以后, 进行构造, 动作, 及绝缘阻抗, 耐压的测试, 结果需要符合 SPEC。(在低温时无水滴凝结现象)

Relay should be kept in temperature chamber at $-40 \pm 2^{\circ}\text{C}$ for 72 hours. Then the Relays shall be maintained at standard atmospheric condition for 1 to 2 hours after which measurement shall be made.

Construction, Relay operation, Insulation Resistance and Dielectric Strength shall satisfy the specification requirements. (No condensation of water drops under low temperature condition)

5.4 耐热性:
Heat Resistance:

5.4.1 使用耐热性:
Heat Resistance in
Use:

继电器操作回路提供定格电压, 在接点部份提供定格电流的状态下, 在恒温箱以 $70 \pm 2^{\circ}\text{C}$ 的温度连续保持 2 小时后, 保持原状态进行继电器动作之测试, 结果必须符合 SPEC。

Relay should be kept in temperature chamber at $70 \pm 2^{\circ}\text{C}$ for two hours that rated Voltage should be supplied to Coil while rated Current should be supplied to Contacts. Such condition shall be maintained while the rated voltage is supplied to Relay, then Relay shall operate normally.

5.4.2 储存耐热性:
Storage Heat
Resistance

继电器在恒温箱以 $70 \pm 2^{\circ}\text{C}$ 的温度连续保持 16 小时, 在常温, 常湿状态下, 放置 1-2 小时后, 进行构造, 动作, 及绝缘阻抗, 耐压的测试, 结果需要符合 SPEC。

Relay should be kept in temperature chamber at $70 \pm 2^{\circ}\text{C}$ for 16 hours. Then the Relays shall be maintained at standard atmospheric condition for 1 to 2 hours after which measurement shall be made.

Construction, Relay operation, Insulation Resistance and Dielectric Strength shall satisfy the specification requirements.

5.5 耐湿性:
Moisture Resistance:

继电器以温度 $40 \pm 2^{\circ}\text{C}$ 相对湿度在 85% 环境下连续保持 48 小时, 接着, 于常温常湿放置 1-2 小时后, 进行构造, 动作, 及绝缘阻抗, 耐压的测试, 结果需要符合 SPEC。

Relay should be kept in temperature chamber at $40 \pm 2^{\circ}\text{C}$ (90~95% RH) for 48 hours. Then the Relays shall be maintained at standard atmospheric condition for 1 to 2 hours after which measurement shall be made. Construction, Relay operation, Insulation Resistance, Dielectric Strength shall satisfy the specification requirements.

6. 端脚特性:
Terminal Characteristics:

- 6.1 端脚强度:
Terminal Strength: 在水平方向负重 300 克持续 1 分钟, 测试完成后端脚不能有任何的松脱或是弯曲。
A load of 300g should be applied to the Terminal for one minute in horizontal direction. There should not be any looseness or bending of Terminals.
- 6.2 沾锡测试:
Soldering Dip Test: 温度 $230 \pm 5^{\circ}\text{C}$, 时间 3 ± 0.5 秒, 浸渍端子前端 3mm, 须沾锡面积需达 90% 以上。
The front 3 mm of Terminal should be immersed for 3 ± 0.5 seconds at $230 \pm 5^{\circ}\text{C}$. Soldered area must be minimum 90% of the soldering surface.
- 6.3 沾锡耐热性:
Soldering Heat Resistance: 当端脚浸到 350°C 的锡炉内 3 秒钟时, 继电器必须能符合所有的电气与机械规格之要求, 且外观不会有改变。
When the Terminal are immersed into soldering bath at 350°C for 3 seconds, the Relay shall satisfy all electrical and mechanical specifications and must not have excessive change in outside appearance.
7. 重量:
Weight: 约 13 克
Approx. 13g
8. 抽样检查标准:
Sample Test Method: GB2828-2000 之抽样标准中, 以一般检查水准 II 级 AQL - 0.4 为依据。
GB2828-2000 Level - General II, AQL 0.4.

外型尺寸 (mm)

Dimensin (mm)

HK115FD-XXX-XX2C

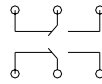
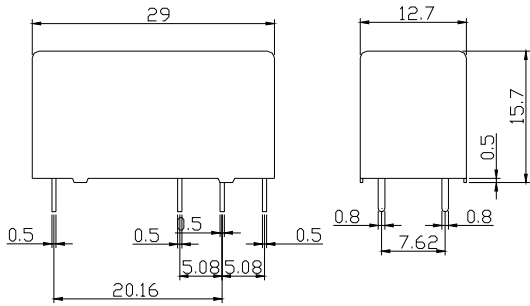

BOTTOM VIEW
(2C)

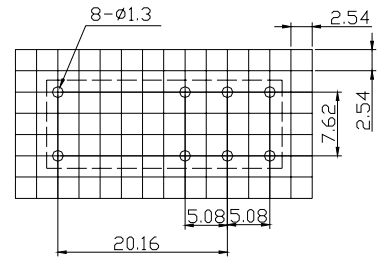

BOTTOM VIEW
(2C)

HK115FD-XXX-XX2A

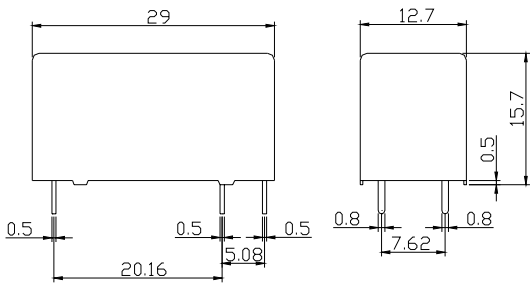

BOTTOM VIEW
(2A)

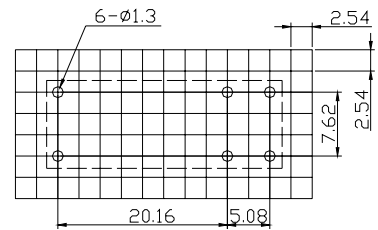

BOTTOM VIEW
(2A)

HK115FD-XXX-XX2B

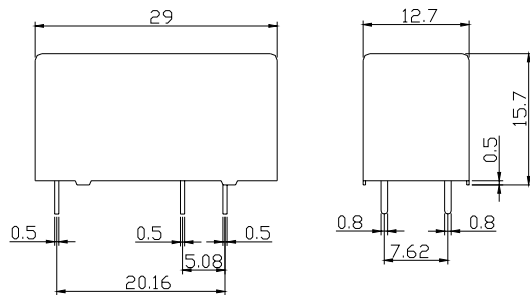

BOTTOM VIEW
(2B)

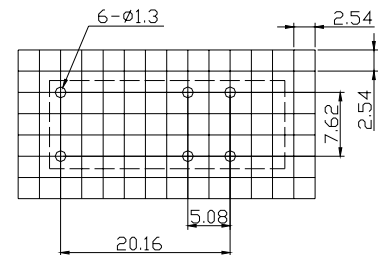

BOTTOM VIEW
(2B)

Tolerance : ± 0.2

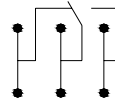
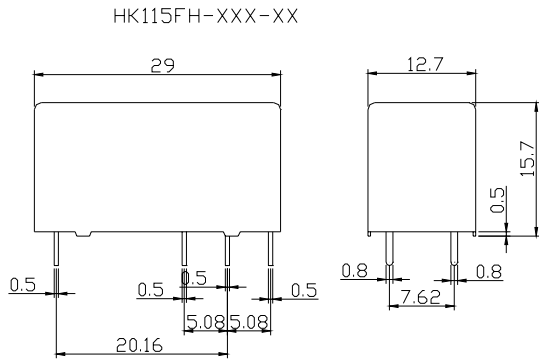

BOTTOM VIEW
(1C)

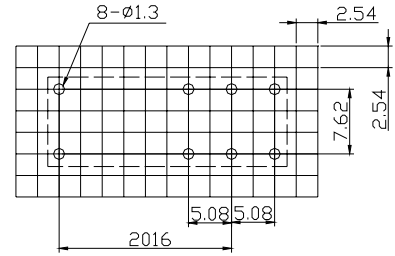

BOTTOM VIEW
(1C)

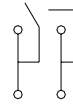
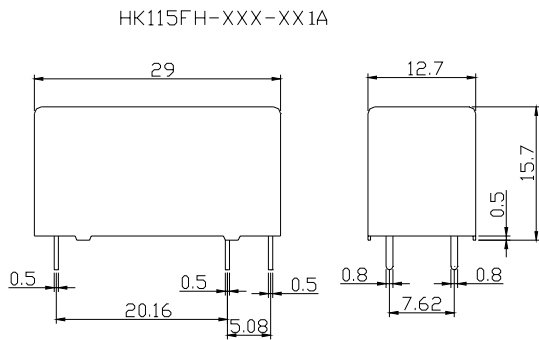

BOTTOM VIEW
(1A)

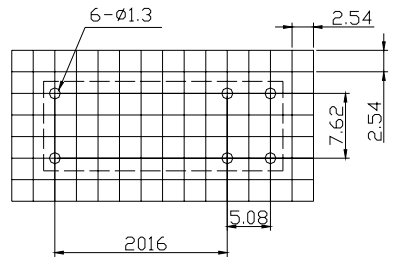

BOTTOM VIEW
(1A)

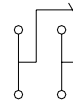
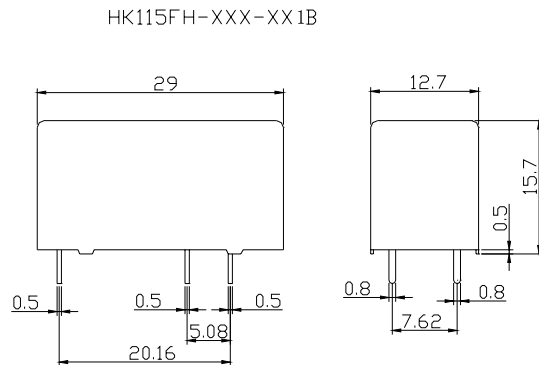

BOTTOM VIEW
(1B)

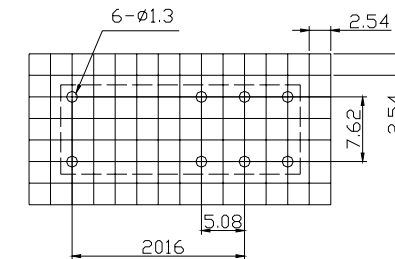

BOTTOM VIEW
(1B)

Tolerance : ±0.2

HK115F-XXX-XX

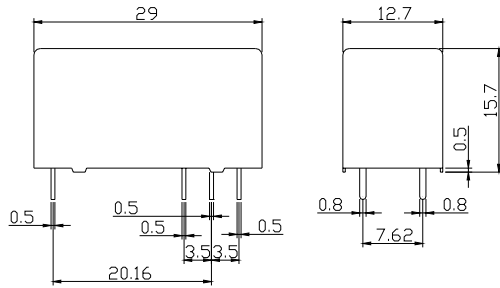

BOTTOM VIEW
(1C)

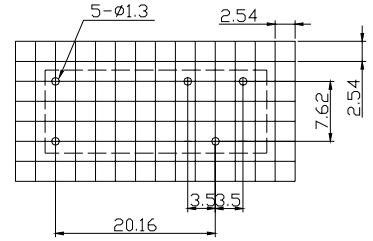

BOTTOM VIEW
(1C)

HK115F-XXX-XX1A

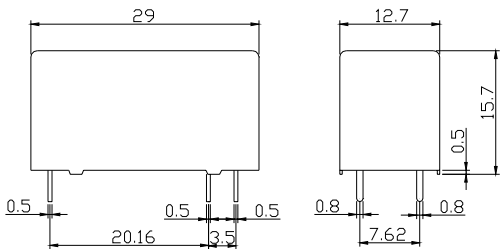

BOTTOM VIEW
(1A)

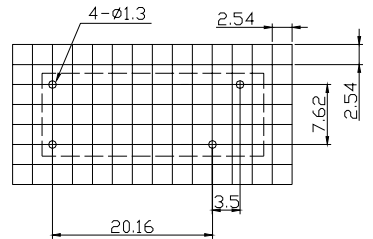

BOTTOM VIEW
(1A)

HK115F-XXX-XX1B

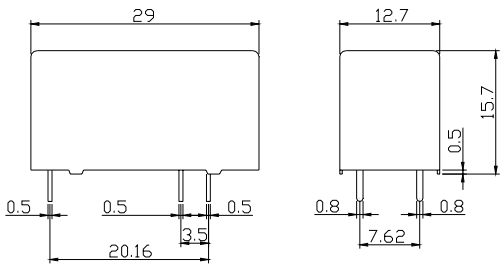

BOTTOM VIEW
(1B)

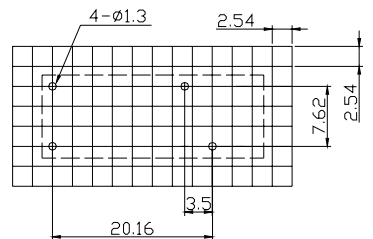

BOTTOM VIEW
(1B)

Tolerance : ±0.2