

General

- Slow Blow
- 3.10mmx 1.55mm physical size
- Thick film manufacturing method, ceramic substrate, silver fusing element
- -55°C~125°C operating temperature
- Excellent environmental integrity
- RoHS compliant
- Halogen-free
- Lead free

Agency / Certificate Information

| Agency | File Number | Ampere Range |
|--|-------------|--------------|
|  | E319512 | 0.5A~7A |

Application

- Battery pack
- PC related equipment and peripherals (Hard driver, Printer, etc.)
- Digital camera (Digital still camera)
- Game equipment
- LCD monitor, LCD modules
- Wireless base station
- Power supply
- Medical device

Electrical Specifications

| Part Number | Marking | Current Rating (A) | Voltage Rating (V) | Interrupting Rating (V) | Typical Cold DCR* (mΩ) | Typical I ² T** (A ² s) |
|---------------|---------|--------------------|--------------------|-------------------------|------------------------|---|
| S1206-S-0.5A | F | 0.5 | 32 | 50A 32V DC | 1200 | 0.0075 |
| S1206-S-0.75A | G | 0.75 | 32 | | 540 | 0.0169 |
| S1206-S-1.0A | H | 1.0 | 32 | | 320 | 0.1945 |
| S1206-S-1.5A | K | 1.5 | 32 | | 140 | 0.4137 |
| S1206-S-2.0A | N | 2.0 | 32 | | 92 | 0.4383 |
| S1206-S-2.5A | O | 2.5 | 32 | | 65 | 0.7343 |
| S1206-S-3.0A | P | 3.0 | 32 | | 36 | 1.5267 |
| S1206-S-3.5A | R | 3.5 | 32 | | 30 | 1.5312 |
| S1206-S-4.0A | S | 4.0 | 32 | 35A 32V DC | 23 | 2.5356 |
| S1206-S-5.0A | T | 5.0 | 32 | | 16 | 3.3999 |
| S1206-S-6.0A | 6 | 6.0 | 32 | | 12.5 | 5.7505 |
| S1206-S-7.0A | U | 7.0 | 32 | | 7.0 | 8.8200 |

* Measured at ≤10% rated current and 25°C

** Melting I²T at 10 times of rated current

Part Number Information

S 1206-S-1.0A

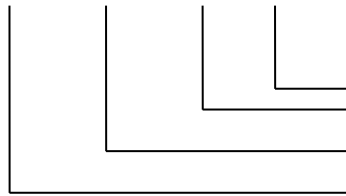

- “1.0A” Ampere Rating: 1A
- “S” Electrical Characteristic: S = Slow Blow
- “1206” Size Number
- “S” Symbol of SART

Dimensions

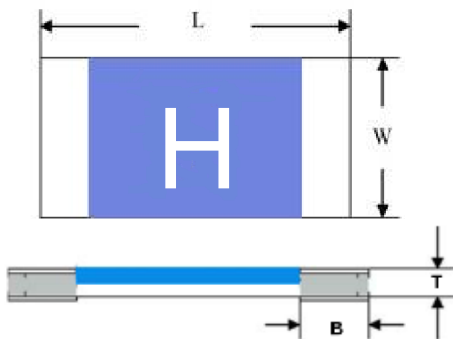

| Type | L (mm) | W (mm) | T (mm) | B (mm) |
|---------|-----------|-----------|-----------|-----------|
| S1206-S | 3.10±0.20 | 1.55±0.20 | 0.55±0.20 | 0.50±0.20 |

Recommended Land Patterns

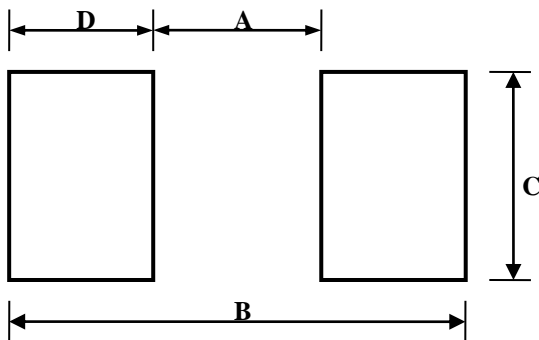

| Dimensions | A(mm) | B(mm) | C(mm) | D(mm) |
|------------|-----------|-----------|-----------|-----------|
| Spec | 2.00±0.30 | 4.40±0.50 | 2.40±0.30 | 1.20±0.30 |

Materials

| Components | Material |
|--------------|------------------------------------|
| Body | Ceramic |
| Terminations | Silver over plated with tin (100%) |
| Element | Silver or Silver/Palladium |

Dimensions of Standard Test Board

| Type | Ampere Rating | Board Thickness (mm) | Copper Layer Thickness (mm) | Copper Trace Width (mm) |
|---------|---------------|----------------------|-----------------------------|-------------------------|
| S1206-S | 0.5A~6.0A | 1.6 | 0.035 | 5.0 |
| | 7.0A | 1.6 | 0.070 | 7.5 |

Time Current Curve

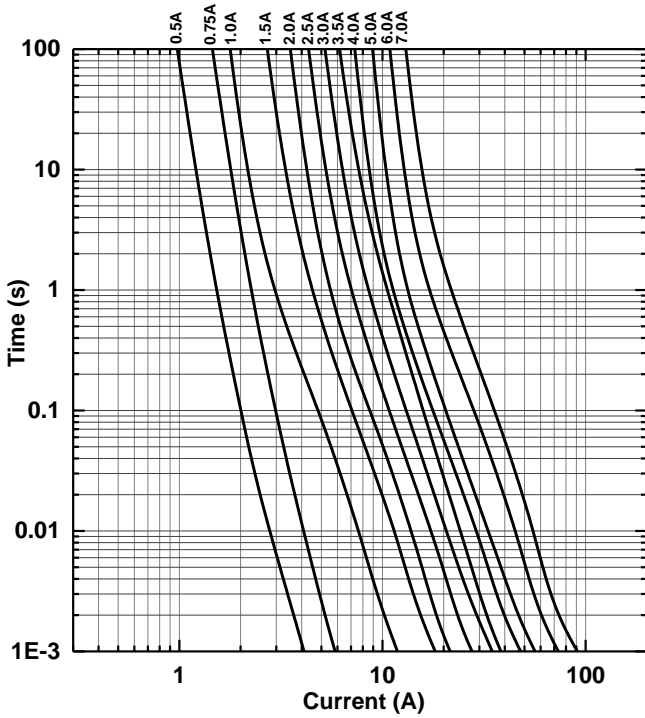

I²T VS Time Curve

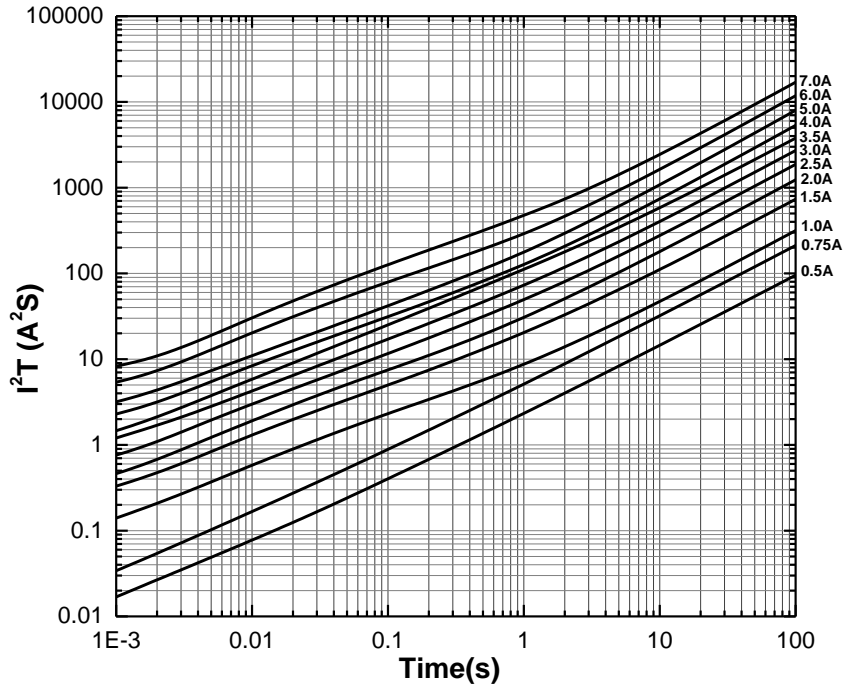

Electrical Characteristics

| Type | Ampere Rating | % of Current Rating | Opening Time |
|---------|---------------|---------------------|--------------|
| S1206-S | 0.5A~7.0A | 100 | >4hours |
| | 1.0A~7.0A | 200 | ≤60sec |
| | 0.5A~0.75A | 250 | ≤20sec |
| | 0.5A~0.75A | 1000 | >0.1ms |
| | 1.0A~7.0A | 1000 | >1.0ms |

Temperature Derating Curve

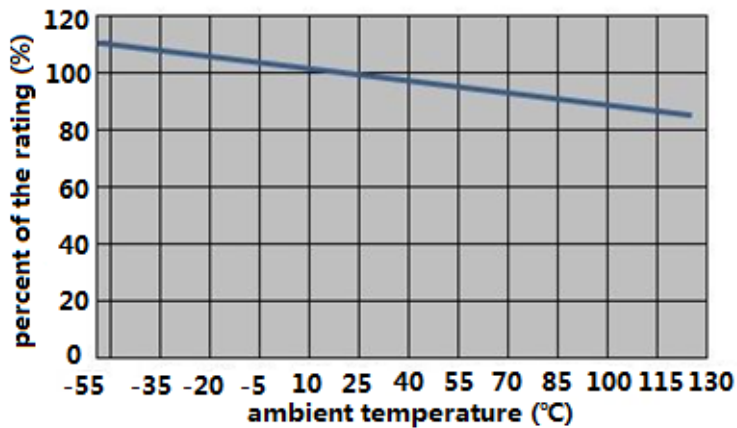

Product Characteristics

| Item | Test condition/ Methods | Performance | Standard |
|---------------------------------|--|--|---|
| Time/Current | 100% of current rating | No Fusing, 4hours Min. | UL248-14 |
| | 200% of current rating | 1.0A~7.0A:≤60sec | SART SPEC. |
| | 250% of current rating | 0.5A~0.75A:≤20sec | |
| | 1000% of current rating | 0.5A~0.75A:>0.1ms 1.0A~7.0A:> 1.0ms | IEC60127-4 |
| Voltage Drop | 100% of current rating | Deviation between the mean value: <15% | IEC60127-4 |
| Temperature Rise | 100% of current rating | $\Delta T < 75^{\circ}\text{C}$ | IEC60127-4 |
| Endurance Test | 100 cycles of 1In for 1h "ON", for 15min "OFF", then following by 1h of 125%In | $ \Delta R < 10\%$ | IEC60127-4 |
| Interrupting Ability | 0.5A~3.5A: 50A 32V DC 4.0A~7.0A: 35A 32V DC | without permanent arcing, ignition and bursting of fuse link | UL248-14 IEC60127-4 |
| Solderability | 240°C±5°C, 3sec±0.5sec | 95% coverage Min. | IEC60127-4 MIL-STD-202 Method 208 |
| Resistance to Soldering | 260°C±5°C, 10sec±0.5sec | $ \Delta R < 10\%$ Legible appearance | MIL-STD-202 Method 210 |
| Bending Test | Distance between holding points: 90mm Bending: 1mm, time: 10sec | $ \Delta R < 10\%$ No mechanical damages | IEC60127-4 |
| High Temperature Operating Life | T=70°C±2°C, 60%In, 96hours | $ \Delta R < 10\%$; No fusing | MIL-STD-202 Method 108 |
| Humidity (Steady State) | T=40°C±2°C, 90%~95%RH, 1000hours | $ \Delta R < 10\%$ | MIL-STD-202 Method 103 |
| Low Temperature Storage | T=-55°C±3°C, 96hours | $ \Delta R < 10\%$ | IEC60068-2-1 |
| High Temperature Storage | T=125°C±2°C, 96hours | $ \Delta R < 10\%$ | IEC60068-2-2 |
| Salt Spray | 5% salt solution, 48hours | $ \Delta R < 10\%$ Legible appearance | MIL-STD-202 Method 101 |
| Thermal Shock | 100 cycles between -65°C/+125°C 60 minutes, each extreme | $ \Delta R < 10\%R$ No mechanical damages | MIL-STD-202 Method 107 |

Recommended Solder Curve

1. Infrared Reflow:

- Temperature: 260°C
- Time: 5sec Max.
- Recommend Reflow profile

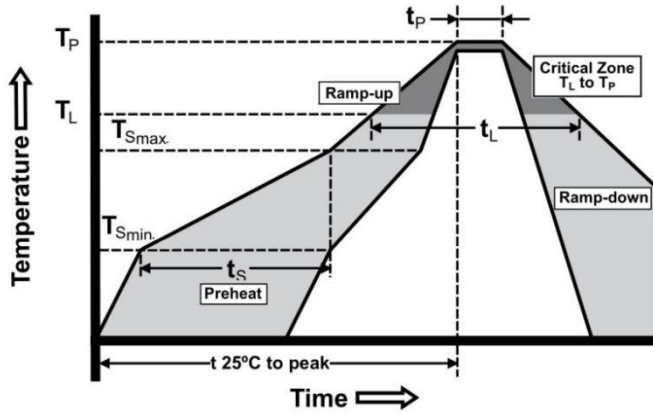

| Profile Feature | Pb-Free Assembly |
|---|------------------|
| Average Ramp-up Rate(T_{Smax} to T_P) | 3°C/sec Max. |
| Preheat Temperature Min.(T_{Smin}) | 150°C |
| Temperature Max.(T_{Smax}) | 200°C |
| Time(T_{Smin} to T_{Smax}) | 60sec~120sec |
| Peak Temperature(T_P) | 260°C |
| Time within 5°C of actual Peak Temperature(T_P) | 5sec |
| Melting tin time(T_L) | 20sec~30sec |
| Ramp-down Rate | 6°C/sec Max. |
| Time 25°C to peak Temperature | 8minutes Max. |

2. Wave soldering

- Reservoir Temperature: 260°C
- Time in Reservoir: 10secMax.

3.Hand Soldering

- Temperature: 350°C
- Time: 5secMax.

Packaging

- 5000 pieces of fuses in emboss taper and reeled on a 178mm(7 inch) reel.

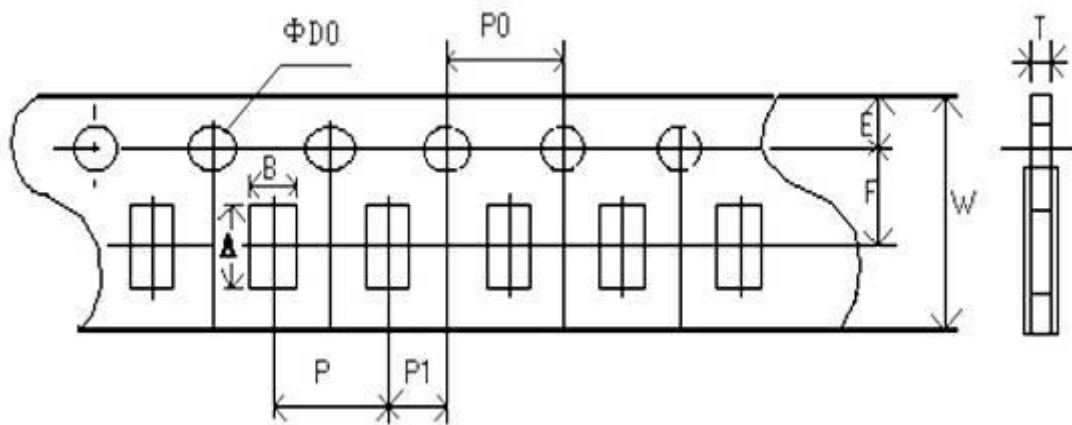

| | | | | | |
|------|-----------|-----------|-----------|-----------|-----------|
| Type | A(mm) | B(mm) | W(mm) | E(mm) | F(mm) |
| Spec | 3.50±0.20 | 1.90±0.20 | 8.00±0.20 | 1.75±0.10 | 3.50±0.05 |
| Type | P(mm) | P0(mm) | P1(mm) | D0(mm) | T(mm) |
| Spec | 4.00±0.10 | 4.00±0.10 | 2.00±0.10 | 1.50±0.10 | 0.75±0.10 |



| Type | M(mm) | W(mm) | T(mm) | A(mm) | B(mm) | C(mm) | D(mm) |
|------|-------------|-----------|------------|-----------|------------|------------|------------|
| Spec | 178.00±2.00 | 9.50±1.00 | 12.50±1.50 | 2.00±0.50 | 13.00±0.50 | 21.00±0.50 | 58.00±2.00 |

Storage

- The ambient temperature recommended for storage shall be between 5°C~30°C
- The relative humidity recommended for storage shall be between 25%RH~60%RH
- Sealed plastic bags with desiccant shall be used to reduce the oxidation of the termination and shall only be opened prior to use
- The products shall not be stored in areas where harmful gases containing sulfur or chlorine are present