

## Contents

Features .....	1
Applications.....	1
Block diagram .....	1
Pin Assignment .....	2
Ordering Information .....	2
Absolute Maximum Ratings .....	2
Electrical Characteristics.....	3
Test Circuits .....	9
Operation .....	10
Selection of External Parts .....	12
Standard Circuits.....	15
Application Circuits .....	16
Notes on Design .....	18
Dimensions .....	18
Markings .....	19
Taping .....	19
Characteristics .....	20

The S-8435/8436 Series is a CMOS step-up switching regulator that consists of a reference voltage source, a CR oscillation circuit, a power MOS FET, a diode, and a comparator. The output voltage is fixed internally, and a shutdown function is available. The current consumption is drastically minimized because of the CMOS configuration. They feature low voltage operation. The S-8435 Series easily forms a step-up switching regulator using only an external coil and capacitor. The S-8436 Series employs an external transistor to boost the available output current. These series are suitable for use as power sources for portable devices because of their small 5-pin package and few external parts.

### ■ Features

- Low voltage operation : 0.9 V min.
- Low current consumption Operation: 5.0  $\mu$ A typ.  
Shutdown: 0.2  $\mu$ A max.
- Shutdown function
- Large output currents can be obtained with an external transistor (S-8436 series).
- Built-in CR oscillation circuit
- Built-in schottky diode (S-8435 series)
- High-precision output voltage
- SOT-89-5 package

### ■ Applications

- Power supplies for portable equipment such as pager, handy calculator, remote controller
- Constant voltage power supplies for camera, video equipment, or communications equipment
- Power supply for microcomputer

### ■ Block Diagram

(1) S-8435 Series

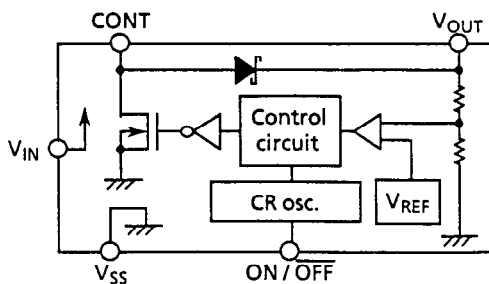

(2) S-8436 Series

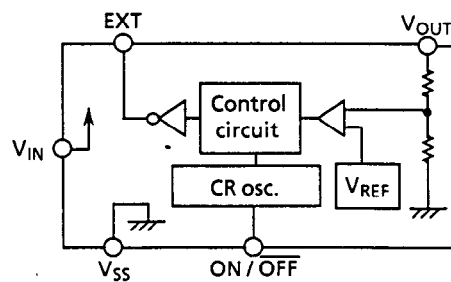

Figure 1 Block diagram

# STEP-UP SWITCHING REGULATORS

## S-8435/8436 Series

### Pin Assignment

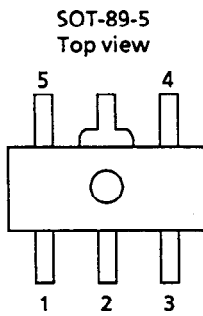
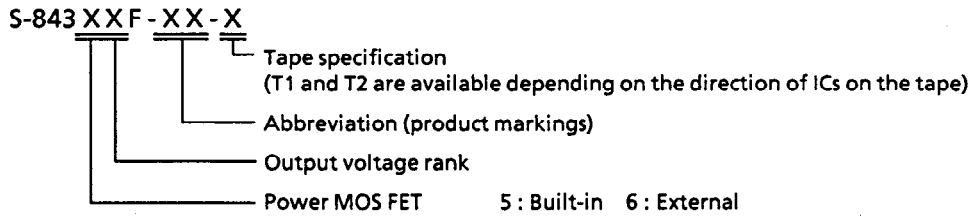

Figure 2

No.	S-8435	S-8436	Description
1	CONT	EXT	CONT: External inductor connection terminal EXT: External transistor connection terminal
2	V <sub>SS</sub>		GND terminal
3	ON/OFF		Shutdown terminal "H": Normal operation (step-up) "L": Step-up stop (oscillation circuit stop)
4	V <sub>IN</sub>		Positive power terminal
5	V <sub>OUT</sub>		Output voltage terminal

### Ordering Information

#### 1. Product name configuration



#### 2. Product list

Output voltage	S-8435XF Series	S-8436XF Series
1.5 V ± 3%	S-8435AF-SK-X	S-8436AF-XK-X
3.0 V ± 3%	S-8435BF-SB-X	S-8436BF-XB-X
3.6 V ± 3%	S-8435DF-S7-X	S-8436DF-X7-X
3.7 V ± 3%	S-8435EF-SE-X	—
4.4 V ± 3%	S-8435GF-WD-X	—
5.0 V ± 3%	S-8435CF-SD-X	S-8436CF-XD-X
5.2 V ± 3%	—	S-8436HF-XL-X
12.0 V ± 3%	S-8435FF-WK-X	S-8436FF-YK-X

Note: Please ask our sales person if you need another output voltage product.

### Absolute Maximum Ratings

T<sub>a</sub> = 25°C

Parameter	Symbol	Ratings	Unit
Supply voltage	V <sub>IN</sub>	13	V
Input voltage	CONT, ON/OFF, EXT, V <sub>OUT</sub>	V <sub>SS</sub> - 0.3 to 13	V
Power dissipation	P <sub>D</sub>	500	mW
Operating temperature	T <sub>opr</sub>	- 40 to + 85	°C
Storage temperature	T <sub>stg</sub>	- 40 to + 125	°C

■ **Electrical Characteristics**

1. S-8435AF-SK-X

(Unless otherwise specified : Ta = 25°C)

Parameter	Symbol	Test conditions	Min.	Typ.	Max.	Unit	Test circuit
Supply voltage	V <sub>IN</sub>		—	—	10	V	1
Start voltage	V <sub>ST</sub>	I <sub>OUT</sub> = 100 μA, V <sub>OUT</sub> ≥ 1.35 V	—	—	0.9	V	1
Oscillating frequency	f <sub>OSC</sub>	V <sub>IN</sub> = 1.2 V	20	30	50	kHz	2
Current consumption	I <sub>SS</sub>	V <sub>IN</sub> = 1.2 V, ON/OFF = high	—	5	15	μA	3
Shutdown current	I <sub>SSS</sub>	V <sub>IN</sub> = 1.2 V, ON/OFF = low	—	—	0.2	μA	4
Output voltage	V <sub>OUT</sub>	V <sub>IN</sub> = 1.2 V, I <sub>OUT</sub> = 5 mA	1.45	1.5	1.55	V	1
Line regulation	ΔV <sub>OUT1</sub>	V <sub>IN</sub> = 0.9 to 1.2 V, I <sub>OUT</sub> = 5 mA	—	30	100	mV	1
Load regulation	ΔV <sub>OUT2</sub>	V <sub>IN</sub> = 1.2 V I <sub>OUT</sub> = 10 μA to 10 mA	—	30	100	mV	1
Output voltage temperature coefficient	$\frac{\Delta V_{OUT}}{\Delta T_a}$	Ta = -40°C to +85°C	—	± 0.38	—	mV/°C	—
Switching current	I <sub>SW</sub>	V <sub>DS</sub> = 0.2 V	—	250	—	mA	—
Switching transistor leakage current	I <sub>SWQ</sub>	V <sub>DS</sub> = 10 V	—	—	1.0	μA	5
Shutdown terminal input voltage	V <sub>SH</sub>	V <sub>IN</sub> = 1.2 V, high level	0.9	—	—	V	3
	V <sub>SL</sub>	V <sub>IN</sub> = 1.2 V, low level	—	—	0.4	V	3
Output voltage at shutdown	V <sub>OUTOFF</sub>	V <sub>IN</sub> = 1.2 V, ON/OFF = low I <sub>OUT</sub> = 100 μA When using the built-in Schottky diode	0.6	—	—	V	1

Following external parts are used :

Coil: RCH855 (820 μH), Sumida Electric Co., Ltd. or equivalent.

Diode: D1N54, Shindengen Co., Ltd. or equivalent.

Capacitor: CACFM1A220M (22 μF), Marcon Electric Co., Ltd. or equivalent.

2. S-8435BF-SB-X

(Unless otherwise specified : Ta = 25°C)

Parameter	Symbol	Test conditions	Min.	Typ.	Max.	Unit	Test circuit
Supply voltage	V <sub>IN</sub>		—	—	10	V	1
Start voltage	V <sub>ST</sub>	I <sub>OUT</sub> = 100 μA, V <sub>OUT</sub> ≥ 2.7 V	—	—	0.9	V	1
Oscillating frequency	f <sub>OSC</sub>	V <sub>IN</sub> = 1.5 V	20	30	50	kHz	2
Current consumption	I <sub>SS</sub>	V <sub>IN</sub> = 1.5 V, ON/OFF = high	—	5	15	μA	3
Shutdown current	I <sub>SSS</sub>	V <sub>IN</sub> = 1.5 V, ON/OFF = low	—	—	0.2	μA	4
Output voltage	V <sub>OUT</sub>	V <sub>IN</sub> = 1.5 V, I <sub>OUT</sub> = 20 mA	2.91	3.0	3.09	V	1
Line regulation	ΔV <sub>OUT1</sub>	V <sub>IN</sub> = 1.5 to 2 V, I <sub>OUT</sub> = 20 mA	—	30	100	mV	1
Load regulation	ΔV <sub>OUT2</sub>	V <sub>IN</sub> = 1.5 V I <sub>OUT</sub> = 10 μA to 25 mA	—	30	100	mV	1
Output voltage temperature coefficient	$\frac{\Delta V_{OUT}}{\Delta T_a}$	Ta = -40°C to +85°C	—	± 0.38	—	mV/°C	—
Switching current	I <sub>SW</sub>	V <sub>DS</sub> = 0.2 V	—	250	—	mA	—
Switching transistor leakage current	I <sub>SWQ</sub>	V <sub>DS</sub> = 10 V	—	—	1.0	μA	5
Shutdown terminal input voltage	V <sub>SH</sub>	V <sub>IN</sub> = 1.5 V, high level	1.0	—	—	V	3
	V <sub>SL</sub>	V <sub>IN</sub> = 1.5 V, low level	—	—	0.4	V	3
Output voltage at shutdown	V <sub>OUTOFF</sub>	V <sub>IN</sub> = 1.5 V, ON/OFF = low I <sub>OUT</sub> = 100 μA When using the built-in Schottky diode	0.9	—	—	V	1

Following external parts are used :

Coil: RCH855 (47 μH), Sumida Electric Co., Ltd. or equivalent.

Diode: D1N54, Shindengen Co., Ltd. or equivalent.

Capacitor: CACFM1A220M (22 μF), Marcon Electric Co., Ltd. or equivalent.

# STEP-UP SWITCHING REGULATORS

## S-8435/8436 Series

### 3. S-8435CF-SD-X

(Unless otherwise specified : Ta = 25°C)

Parameter	Symbol	Test conditions	Min.	Typ.	Max.	Unit	Test circuit
Supply voltage	V <sub>IN</sub>		—	—	10	V	1
Shutdown voltage	V <sub>ST</sub>	I <sub>OUT</sub> = 100 μA, V <sub>OUT</sub> ≥ 4.5 V	—	—	0.9	V	1
Oscillating frequency	f <sub>OSC</sub>	V <sub>IN</sub> = 3 V	20	30	50	kHz	2
Current consumption	I <sub>SS</sub>	V <sub>IN</sub> = 3 V, ON/OFF = high	—	5	15	μA	3
Standby current	I <sub>SSS</sub>	V <sub>IN</sub> = 3 V, ON/OFF = low	—	—	0.2	μA	4
Output voltage	V <sub>OUT</sub>	V <sub>IN</sub> = 3 V, I <sub>OUT</sub> = 20 mA	4.85	5.0	5.15	V	1
Line regulation	ΔV <sub>OUT1</sub>	V <sub>IN</sub> = 2 to 3 V, I <sub>OUT</sub> = 20 mA	—	30	100	mV	1
Load regulation	ΔV <sub>OUT2</sub>	V <sub>IN</sub> = 3 V I <sub>OUT</sub> = 10 μA to 25 mA	—	30	100	mV	1
Output voltage temperature coefficient	$\frac{\Delta V_{OUT}}{\Delta T_a}$	Ta = -40°C to +85°C	—	± 0.38	—	mV/°C	—
Switching current	I <sub>SW</sub>	V <sub>DS</sub> = 0.2 V	—	250	—	mA	—
Switching transistor leakage current	I <sub>SWQ</sub>	V <sub>DS</sub> = 10 V	—	—	1.0	μA	5
Shutdown terminal input voltage	V <sub>SH</sub>	V <sub>IN</sub> = 3 V, high level	1.5	—	—	V	3
	V <sub>SL</sub>	V <sub>IN</sub> = 3 V, low level	—	—	0.4	V	3
Output voltage at shutdown	V <sub>OUTOFF</sub>	V <sub>IN</sub> = 3 V, ON/OFF = low I <sub>OUT</sub> = 100 μA When using the built-in Schottky diode	2.4	—	—	V	1

Following external parts are used :

Coil: RCH855 (47 μH), Sumida Electric Co., Ltd. or equivalent.

Diode: D1N54, Shindengen Co., Ltd. or equivalent.

Capacitor: CACFM1A220M (22 μF), Marcon Electric Co., Ltd. or equivalent.

### 4. S-8435DF-S7-X

(Unless otherwise specified : Ta = 25°C)

Parameter	Symbol	Test conditions	Min.	Typ.	Max.	Unit	Test circuit
Supply voltage	V <sub>IN</sub>		—	—	10	V	1
Shutdown voltage	V <sub>ST</sub>	I <sub>OUT</sub> = 100 μA, V <sub>OUT</sub> ≥ 3.24 V	—	—	0.9	V	1
Oscillating frequency	f <sub>OSC</sub>	V <sub>IN</sub> = 2 V	20	30	50	kHz	2
Current consumption	I <sub>SS</sub>	V <sub>IN</sub> = 2 V, ON/OFF = high	—	5	15	μA	3
Standby current	I <sub>SSS</sub>	V <sub>IN</sub> = 2 V, ON/OFF = low	—	—	0.2	μA	4
Output voltage	V <sub>OUT</sub>	V <sub>IN</sub> = 2 V, I <sub>OUT</sub> = 20 mA	3.49	3.6	3.71	V	1
Line regulation	ΔV <sub>OUT1</sub>	V <sub>IN</sub> = 1.5 to 2 V, I <sub>OUT</sub> = 20 mA	—	30	100	mV	1
Load regulation	ΔV <sub>OUT2</sub>	V <sub>IN</sub> = 2 V I <sub>OUT</sub> = 10 μA to 25 mA	—	30	100	mV	1
Output voltage temperature coefficient	$\frac{\Delta V_{OUT}}{\Delta T_a}$	Ta = -40°C to +85°C	—	± 0.38	—	mV/°C	—
Switching current	I <sub>SW</sub>	V <sub>DS</sub> = 0.2 V	—	250	—	mA	—
Switching transistor leakage current	I <sub>SWQ</sub>	V <sub>DS</sub> = 10 V	—	—	1.0	μA	5
Shutdown terminal input voltage	V <sub>SH</sub>	V <sub>IN</sub> = 2 V, high level	1.5	—	—	V	3
	V <sub>SL</sub>	V <sub>IN</sub> = 2 V, low level	—	—	0.4	V	3
Output voltage at shutdown	V <sub>OUTOFF</sub>	V <sub>IN</sub> = 2 V, ON/OFF = low I <sub>OUT</sub> = 100 μA When using the built-in Schottky diode	1.4	—	—	V	1

Following external parts are used :

Coil: RCH855 (47 μH), Sumida Electric Co., Ltd. or equivalent.

Diode: D1N54, Shindengen Co., Ltd. or equivalent.

Capacitor: CACFM1A220M (22 μF), Marcon Electric Co., Ltd. or equivalent.

5. S-8435EF-SE-X

(Unless otherwise specified : Ta = 25°C)

Parameter	Symbol	Test conditions	Min.	Typ.	Max.	Unit	Test circuit
Supply voltage	V <sub>IN</sub>		—	—	10	V	1
Start voltage	V <sub>ST</sub>	I <sub>OUT</sub> = 100 μA, V <sub>OUT</sub> ≥ 3.33 V	—	—	0.9	V	1
Oscillating frequency	f <sub>OSC</sub>	V <sub>IN</sub> = 2 V	20	30	50	kHz	2
Current consumption	I <sub>SS</sub>	V <sub>IN</sub> = 2 V, ON/OFF = "H"	—	5	15	μA	3
Shutdown current	I <sub>SSS</sub>	V <sub>IN</sub> = 2 V, ON/OFF = "L"	—	—	0.2	μA	4
Output voltage	V <sub>OUT</sub>	V <sub>IN</sub> = 2 V, I <sub>OUT</sub> = 20 mA	3.58	3.7	3.82	V	1
Line regulation	ΔV <sub>OUT1</sub>	V <sub>IN</sub> = 1.5 to 2 V, I <sub>OUT</sub> = 20 mA	—	30	100	mV	1
Load regulation	ΔV <sub>OUT2</sub>	V <sub>IN</sub> = 2 V I <sub>OUT</sub> = 10 μA to 25 mA	—	30	100	mV	1
Output voltage temperature coefficient	$\frac{\Delta V_{OUT}}{\Delta T_a}$	Ta = -40°C to +85°C	—	± 0.38	—	mV/°C	—
Switching current	I <sub>SW</sub>	V <sub>DS</sub> = 0.2 V	—	250	—	mA	—
Switching transistor leakage current	I <sub>SWQ</sub>	V <sub>DS</sub> = 10 V	—	—	1.0	μA	5
Shutdown terminal input voltage	V <sub>SH</sub>	V <sub>IN</sub> = 2 V, high level	1.5	—	—	V	3
	V <sub>SL</sub>	V <sub>IN</sub> = 2 V, low level	—	—	0.4	V	3
Output voltage at shutdown	V <sub>OUTOFF</sub>	V <sub>IN</sub> = 2 V, ON/OFF = low I <sub>OUT</sub> = 100 μA When using the built-in Schottky diode	1.4	—	—	V	1

Following external parts are used :

Coil: RCH855 (47 μH), Sumida Electric Co., Ltd. or equivalent.

Diode: D1N54, Shindengen Co., Ltd. or equivalent.

Capacitor: CACFM1C220M (22 μF), Marcon Electric Co., Ltd. or equivalent.

6. S-8435FF-WK-X

(Unless otherwise specified : Ta = 25°C)

Parameter	Symbol	Test conditions	Min.	Typ.	Max.	Unit	Test circuit
Supply voltage	V <sub>IN</sub>		—	—	10	V	1
Start voltage	V <sub>ST</sub>	I <sub>OUT</sub> = 100 μA, V <sub>OUT</sub> ≥ 10.8 V	—	—	0.9	V	1
Oscillating frequency	f <sub>OSC</sub>	V <sub>IN</sub> = 5 V	12	24	45	kHz	2
Current consumption	I <sub>SS</sub>	V <sub>IN</sub> = 5 V, ON/OFF = high	—	10	22	μA	3
Shutdown current	I <sub>SSS</sub>	V <sub>IN</sub> = 5 V, ON/OFF = low	—	—	0.2	μA	4
Output voltage	V <sub>OUT</sub>	V <sub>IN</sub> = 5 V, I <sub>OUT</sub> = 20 mA	11.64	12.0	12.36	V	1
Line regulation	ΔV <sub>OUT1</sub>	V <sub>IN</sub> = 4 to 6 V, I <sub>OUT</sub> = 20 mA	—	90	150	mV	1
Load regulation	ΔV <sub>OUT2</sub>	V <sub>IN</sub> = 5 V I <sub>OUT</sub> = 10 μA to 25 mA	—	100	180	mV	1
Output voltage temperature coefficient	$\frac{\Delta V_{OUT}}{\Delta T_a}$	Ta = -40°C to +85°C	—	± 0.91	—	mV/°C	—
Switching current	I <sub>SW</sub>	V <sub>DS</sub> = 0.2 V	—	250	—	mA	—
Switching transistor leakage current	I <sub>SWQ</sub>	V <sub>DS</sub> = 10 V	—	—	1.0	μA	5
Shutdown terminal input voltage	V <sub>SH</sub>	V <sub>IN</sub> = 5 V, high level	1.5	—	—	V	3
	V <sub>SL</sub>	V <sub>IN</sub> = 5 V, low level	—	—	0.4	V	3
Output voltage at shutdown	V <sub>OUTOFF</sub>	V <sub>IN</sub> = 5 V, ON/OFF = low I <sub>OUT</sub> = 100 μA When using the built-in Schottky diode	4.4	—	—	V	1

Following external parts are used :

Coil: RCH855 (100 μH), Sumida Electric Co., Ltd. or equivalent.

Diode: D1N54, Shindengen Co., Ltd. or equivalent.

Capacitor: CACFM1C220M (22 μF), Marcon Electric Co., Ltd. or equivalent.

# STEP-UP SWITCHING REGULATORS

## S-8435/8436 Series

### 7. S-8435GF-WD-X

(Unless otherwise specified : Ta = 25°C)

Parameter	Symbol	Test conditions	Min.	Typ.	Max.	Unit	Test circuit
Supply voltage	V <sub>IN</sub>		—	—	10	V	1
Shutdown voltage	V <sub>ST</sub>	I <sub>OUT</sub> = 100 μA, V <sub>OUT</sub> ≥ 3.96 V	—	—	0.9	V	1
Oscillating frequency	f <sub>OSC</sub>	V <sub>IN</sub> = 3 V	20	30	50	kHz	2
Current consumption	I <sub>SS</sub>	V <sub>IN</sub> = 3 V, ON/OFF = high	—	5	15	μA	3
Standby current	I <sub>SSS</sub>	V <sub>IN</sub> = 3 V, ON/OFF = low	—	—	0.2	μA	4
Output voltage	V <sub>OUT</sub>	V <sub>IN</sub> = 3 V, I <sub>OUT</sub> = 20 mA	4.268	4.4	4.532	V	1
Line regulation	ΔV <sub>OUT1</sub>	V <sub>IN</sub> = 2 to 3 V, I <sub>OUT</sub> = 20 mA	—	30	100	mV	1
Load regulation	ΔV <sub>OUT2</sub>	V <sub>IN</sub> = 3 V I <sub>OUT</sub> = 10 μA to 25 mA	—	30	100	mV	1
Output voltage temperature coefficient	$\frac{\Delta V_{OUT}}{\Delta T_a}$	Ta = -40°C to +85°C	—	± 0.38	—	mV/°C	—
Switching current	I <sub>SW</sub>	V <sub>DS</sub> = 0.2 V	—	250	—	mA	—
Switching transistor leakage current	I <sub>swQ</sub>	V <sub>DS</sub> = 10 V	—	—	1.0	μA	5
Shutdown terminal input voltage	V <sub>SH</sub>	V <sub>IN</sub> = 3 V, high level	1.5	—	—	V	3
	V <sub>SL</sub>	V <sub>IN</sub> = 3 V, low level	—	—	0.4	V	3
Output voltage at shutdown	V <sub>OUTOFF</sub>	V <sub>IN</sub> = 3 V, ON/OFF = low I <sub>OUT</sub> = 100 μA When using the built-in Schottky diode	2.4	—	—	V	1

Following external parts are used :

Coil: RCH855 (47 μH), Sumida Electric Co., Ltd. or equivalent.

Diode: D1NS4, Shindengen Co., Ltd. or equivalent.

Capacitor: CACFM1A220M (22 μF), Marcon Electric Co., Ltd. or equivalent.

### 8. S-8436AF-XK-X

(Unless otherwise specified : Ta = 25°C)

Parameter	Symbol	Test conditions	Min.	Typ.	Max.	Unit	Test circuit
Supply voltage	V <sub>IN</sub>		—	—	10	V	6
Start voltage	V <sub>ST</sub>		—	—	0.9	V	8
Oscillating frequency	f <sub>OSC</sub>	V <sub>IN</sub> = 1.2 V	20	30	50	kHz	2
Current consumption	I <sub>SS</sub>	V <sub>IN</sub> = 1.2 V, ON/OFF = high	—	5	15	μA	3
Shutdown current	I <sub>SSS</sub>	V <sub>IN</sub> = 1.2 V, ON/OFF = low	—	—	0.2	μA	7
Output voltage	V <sub>OUT</sub>	V <sub>IN</sub> = 1.2 V, I <sub>OUT</sub> = 20 mA	1.45	1.50	1.55	V	6
Line regulation	ΔV <sub>OUT1</sub>	V <sub>IN</sub> = 0.9 to 1.2 V, I <sub>OUT</sub> = 20 mA	—	30	100	mV	6
Load regulation	ΔV <sub>OUT2</sub>	V <sub>IN</sub> = 1.2 V I <sub>OUT</sub> = 10 μA to 25 mA	—	30	100	mV	6
Output voltage temperature coefficient	$\frac{\Delta V_{OUT}}{\Delta T_a}$	Ta = -40°C to +85°C	—	± 0.38	—	mV/°C	6
Output voltage at shutdown	V <sub>SH</sub>	V <sub>IN</sub> = 1.2 V, high level	0.9	—	—	V	3
	V <sub>SL</sub>	V <sub>IN</sub> = 1.2 V, low level	—	—	0.4	V	3

Following external parts are used :

Coil: RCH654 (100 μH), Sumida Electric Co., Ltd. or equivalent.

Diode: D1NS4, Shindengen Co., Ltd. or equivalent.

Capacitor: CACFM1A220M (22 μF), Marcon Electric Co., Ltd. or equivalent.

Transistor: 2SC3279, Toshiba Corp. or equivalent.

9. S-8436BF-XB-X

(Unless otherwise specified : Ta = 25°C)

Parameter	Symbol	Test conditions	Min.	Typ.	Max.	Unit	Test circuit
Supply voltage	V <sub>IN</sub>		—	—	10	V	6
Start voltage	V <sub>ST</sub>		—	—	0.9	V	8
Oscillating frequency	f <sub>OSC</sub>	V <sub>IN</sub> = 1.5 V	20	30	50	kHz	2
Current consumption	I <sub>SS</sub>	V <sub>IN</sub> = 1.5 V, ON/OFF = high	—	5	15	μA	3
Shutdown current	I <sub>SSS</sub>	V <sub>IN</sub> = 1.5 V, ON/OFF = low	—	—	0.2	μA	7
Output voltage	V <sub>OUT</sub>	V <sub>IN</sub> = 1.5 V, I <sub>OUT</sub> = 40 mA	2.91	3.00	3.09	V	6
Line regulation	ΔV <sub>OUT1</sub>	V <sub>IN</sub> = 1.5 to 2.0 V, I <sub>OUT</sub> = 40 mA	—	30	100	mV	6
Load regulation	ΔV <sub>OUT2</sub>	V <sub>IN</sub> = 1.5 V I <sub>OUT</sub> = 10 μA to 50 mA	—	30	100	mV	6
Output voltage temperature coefficient	$\frac{\Delta V_{OUT}}{\Delta T_a}$	Ta = -40°C to +85°C	—	± 0.38	—	mV/°C	6
Output voltage at shutdown	V <sub>SH</sub>	V <sub>IN</sub> = 1.5 V, high level	1.0	—	—	V	3
	V <sub>SL</sub>	V <sub>IN</sub> = 1.5 V, low level	—	—	0.4	V	3

Following external parts are used :

Coil: RCH654 (100 μH), Sumida Electric Co., Ltd. or equivalent.

Diode: D1NS4, Shindengen Co., Ltd. or equivalent.

Capacitor: CACFM1A220M (22 μF), Marcon Electric Co., Ltd. or equivalent.

Transistor: 2SC3279, Toshiba Corp. or equivalent.

10. S-8436CF-XD-X

(Unless otherwise specified : Ta = 25°C)

Parameter	Symbol	Test conditions	Min.	Typ.	Max.	Unit	Test circuit
Supply voltage	V <sub>IN</sub>		—	—	10	V	6
Start voltage	V <sub>ST</sub>		—	—	0.9	V	8
Oscillating frequency	f <sub>OSC</sub>	V <sub>IN</sub> = 3 V	20	30	50	kHz	2
Current consumption	I <sub>SS</sub>	V <sub>IN</sub> = 3 V, ON/OFF = high	—	5	15	μA	3
Shutdown current	I <sub>SSS</sub>	V <sub>IN</sub> = 3 V, ON/OFF = low	—	—	0.2	μA	7
Output voltage	V <sub>OUT</sub>	V <sub>IN</sub> = 3 V, I <sub>OUT</sub> = 40 mA	4.85	5.00	5.15	V	6
Line regulation	ΔV <sub>OUT1</sub>	V <sub>IN</sub> = 2 to 3 V, I <sub>OUT</sub> = 40 mA	—	30	100	mV	6
Load regulation	ΔV <sub>OUT2</sub>	V <sub>IN</sub> = 3 V I <sub>OUT</sub> = 10 μA to 50 mA	—	30	100	mV	6
Output voltage temperature coefficient	$\frac{\Delta V_{OUT}}{\Delta T_a}$	Ta = -40°C to +85°C	—	± 0.38	—	mV/°C	6
Output voltage at shutdown	V <sub>SH</sub>	V <sub>IN</sub> = 3 V, high level	1.5	—	—	V	3
	V <sub>SL</sub>	V <sub>IN</sub> = 3 V, low level	—	—	0.4	V	3

Following external parts are used :

Coil: RCH654 (47 μH), Sumida Electric Co., Ltd. or equivalent.

Diode: D1NS4, Shindengen Co., Ltd. or equivalent.

Capacitor: CACFM1A220M (22 μF), Marcon Electric Co., Ltd. or equivalent.

Transistor: 2SC3279, Toshiba Corp. or equivalent.



**STEP-UP SWITCHING REGULATORS**  
**S-8435/8436 Series**

11. S-8436DF-X7-X

(Unless otherwise specified : Ta = 25°C)

Parameter	Symbol	Test conditions	Min.	Typ.	Max.	Unit	Test circuit
Supply voltage	V <sub>IN</sub>		—	—	10	V	6
Start voltage	V <sub>ST</sub>		—	—	0.9	V	8
Oscillating frequency	f <sub>OSC</sub>	V <sub>IN</sub> = 2 V	20	30	50	kHz	2
Current consumption	I <sub>SS</sub>	V <sub>IN</sub> = 2 V, ON/OFF = high	—	5	15	μA	3
Shutdown current	I <sub>SSS</sub>	V <sub>IN</sub> = 2 V, ON/OFF = low	—	—	0.2	μA	7
Output voltage	V <sub>OUT</sub>	V <sub>IN</sub> = 2 V, I <sub>OUT</sub> = 40 mA	3.49	3.60	3.71	V	6
Line regulation	ΔV <sub>OUT1</sub>	V <sub>IN</sub> = 1.5 to 2 V, I <sub>OUT</sub> = 40 mA	—	30	100	mV	6
Load regulation	ΔV <sub>OUT2</sub>	V <sub>IN</sub> = 2 V I <sub>OUT</sub> = 10 μA to 50 mA	—	30	100	mV	6
Output voltage temperature coefficient	$\frac{\Delta V_{OUT}}{\Delta T_a}$	Ta = -40°C to +85°C	—	±0.38	—	mV/°C	6
Output voltage at shutdown	V <sub>SH</sub>	V <sub>IN</sub> = 2 V, high level	1.5	—	—	V	3
	V <sub>SL</sub>	V <sub>IN</sub> = 2 V, low level	—	—	0.4	V	3

Following external parts are used :

Coil: RCH654 (47 μH), Sumida Electric Co., Ltd. or equivalent.

Diode: D1N54, Shindengen Co., Ltd. or equivalent.

Capacitor: CACFM1A220M (22 μF), Marcon Electric Co., Ltd. or equivalent.

Transistor: 2SC3279, Toshiba Corp. or equivalent.

12. S-8436FF-YK-X

(Unless otherwise specified : Ta = 25°C)

Parameter	Symbol	Test conditions	Min.	Typ.	Max.	Unit	Test circuit
Supply voltage	V <sub>IN</sub>		—	—	10	V	6
Start voltage	V <sub>ST</sub>		—	—	0.9	V	8
Oscillating frequency	f <sub>OSC</sub>	V <sub>IN</sub> = 5 V	12	24	45	kHz	2
Current consumption	I <sub>SS</sub>	V <sub>IN</sub> = 5 V, ON/OFF = high	—	10	22	μA	3
Shutdown current	I <sub>SSS</sub>	V <sub>IN</sub> = 5 V, ON/OFF = low	—	—	0.2	μA	7
Output voltage	V <sub>OUT</sub>	V <sub>IN</sub> = 5 V, I <sub>OUT</sub> = 40 mA	11.64	12.00	12.36	V	6
Line regulation	ΔV <sub>OUT1</sub>	V <sub>IN</sub> = 4 to 6 V, I <sub>OUT</sub> = 40 mA	—	90	150	mV	6
Load regulation	ΔV <sub>OUT2</sub>	V <sub>IN</sub> = 5 V I <sub>OUT</sub> = 10 μA to 50 mA	—	100	180	mV	6
Output voltage temperature coefficient	$\frac{\Delta V_{OUT}}{\Delta T_a}$	Ta = -40°C to +85°C	—	±0.91	—	mV/°C	6
Output voltage at shutdown	V <sub>SH</sub>	V <sub>IN</sub> = 5 V, high level	1.5	—	—	V	3
	V <sub>SL</sub>	V <sub>IN</sub> = 5 V, low level	—	—	0.4	V	3

Following external parts are used :

Coil: RCH855 (100 μH), Sumida Electric Co., Ltd. or equivalent.

Diode: D1N54, Shindengen Co., Ltd. or equivalent.

Capacitor: CACFM1C220M (22 μF), Marcon Electric Co., Ltd. or equivalent.

Transistor: 2SC3279, Toshiba Corp. or equivalent.

13. S-8436HF-XL-X

(Unless otherwise specified : Ta = 25°C)

Parameter	Symbol	Test conditions	Min.	Typ.	Max.	Unit	Test circuit
Supply voltage	V <sub>IN</sub>		—	—	10	V	6
Start voltage	V <sub>ST</sub>		—	—	0.9	V	8
Oscillating frequency	f <sub>OSC</sub>	V <sub>IN</sub> = 3 V	20	30	50	kHz	2
Current consumption	I <sub>SS</sub>	V <sub>IN</sub> = 3 V, ON/OFF = high	—	5	15	μA	3
Shutdown current	I <sub>SSS</sub>	V <sub>IN</sub> = 3 V, ON/OFF = low	—	—	0.2	μA	7
Output voltage	V <sub>OUT</sub>	V <sub>IN</sub> = 3 V, I <sub>OUT</sub> = 40 mA	5.04	5.20	5.36	V	6
Line regulation	ΔV <sub>OUT1</sub>	V <sub>IN</sub> = 2 to 3 V, I <sub>OUT</sub> = 40 mA	—	30	100	mV	6
Load regulation	ΔV <sub>OUT2</sub>	V <sub>IN</sub> = 3 V I <sub>OUT</sub> = 10 μA to 50 mA	—	30	100	mV	6
Output voltage temperature coefficient	$\frac{\Delta V_{OUT}}{\Delta T_a}$	Ta = -40°C to +85°C	—	±0.38	—	mV/°C	6
Output voltage at shutdown	V <sub>SH</sub>	V <sub>IN</sub> = 3 V, high level	1.5	—	—	V	3
	V <sub>SL</sub>	V <sub>IN</sub> = 3 V, low level	—	—	0.4	V	3

Following external parts are used :

Coil: RCH654 (47 μH), Sumida Electric Co., Ltd. or equivalent.

Diode: D1NS4, Shindengen Co., Ltd. or equivalent.

Capacitor: CACFM1A220M (22 μF), Marcon Electric Co., Ltd. or equivalent.

Transistor: 2SC3279, Toshiba Corp. or equivalent.

■ Test Circuits

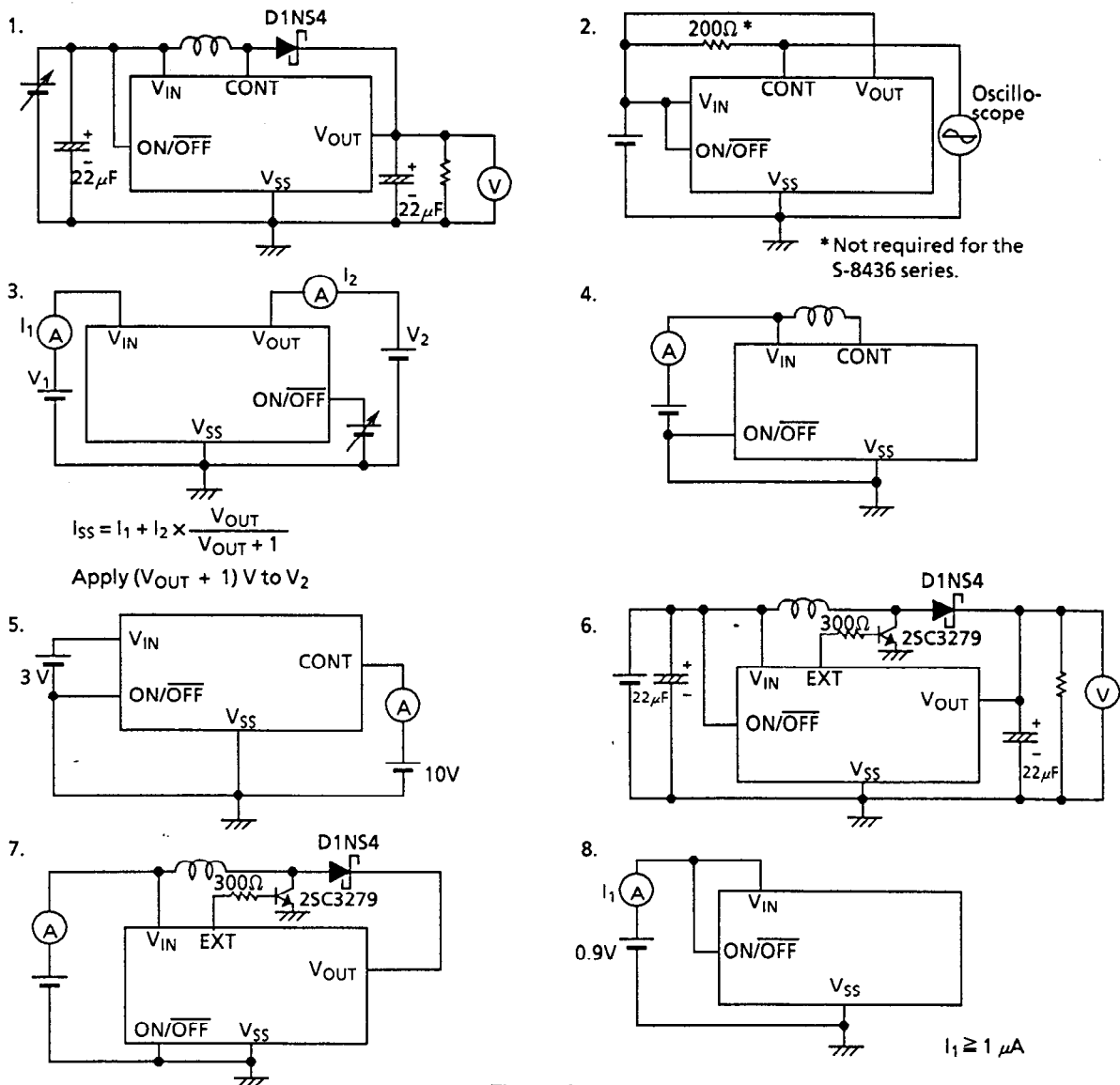

Figure 3

**STEP-UP SWITCHING REGULATORS**  
**S-8435/8436 Series**

■ **Operation**

The S-8435/8436 Series consists of a power MOS FET (M1, external for S-8436), a CR oscillation circuit, and a Schottky diode. M1 is turned on and off by the CR oscillation circuit. When M1 is on ( $t_{ON}$ ), energy is accumulated in the inductor (L). When M1 is off ( $t_{OFF}$ ), the accumulated energy is transferred to the  $V_{OUT}$  capacitor ( $C_{OUT}$ ) through the diode.

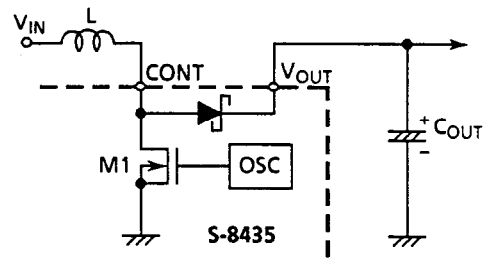

Figure 4

CR oscillation circuit: Oscillator by a capacitor and a resistor. The oscillating frequency is 30 kHz typ.

ON/OFF terminal: Stops or starts step-up operation. If the ON/OFF terminal goes low, the internal circuit operation stops to reduce current consumption. A voltage of  $V_{SS}-0.3$  to 13 V can be applied to the ON/OFF terminal, regardless of the supply voltage.

Shutdown terminal	CR oscillation circuit	Output voltage	Current consumption	Remarks
"H"	Operation	Fixed	15 $\mu$ A typ.	
"L"	Stop	$\approx V_{IN}^*$	0.2 $\mu$ A max.	S-8435: CONT = high impedance S-8436: EXT = $V_{SS}$ level

\* This voltage actually equals  $V_{IN}$  minus the voltage drop due to the DC resistance of the inductor and the diode.

Power MOS FET (S-8435 series only): Large-current Nch MOS transistor  
 Select an inductor to set peak current ( $I_{PK} \leq 500$  mA (whole temperature range)).

Schottky diode: Has almost the same characteristics as the diode 1S1588.

The basic equations ((1) to (7)) of the booster switching regulator are shown below (see Figure 4).

Voltage of a CONT terminal when M1 is on (current  $I_L$  flowing in L is a zero) :

$$V_A = V_S \dots\dots\dots (1)$$

( $V_S$  : M1 non-saturation voltage)

Change by time of  $I_L$  :

$$\frac{dI_L}{dt} = \frac{V_L}{L} = \frac{V_{IN} - V_S}{L} \dots\dots\dots (2)$$

Integral ( $I_L$ ) of the above equation :

$$I_L = \left( \frac{V_{IN} - V_S}{L} \right) \cdot t \dots\dots\dots (3)$$

This  $I_L$  flows for  $t_{ON}$ . This time is determined by the OSC oscillation frequency.

Peak current ( $I_{PK}$ ) in  $t_{ON}$  :

$$I_{PK} = \left( \frac{V_{IN} - V_S}{L} \right) \cdot t_{ON} \dots\dots\dots (4)$$

In this case, the energy accumulated in L is indicated by  $1/2L (I_{PK})^2$ .

Then, when M1 is off ( $t_{OFF}$ ), the energy accumulated in L is transferred to the capacitor through the diode, and a reverse voltage ( $V_L$ ) is generated.  $V_L$  is as follows :

$$V_L = (V_{OUT} + V_D) - V_{IN} \dots\dots\dots (5)$$

( $V_D$  : Forward voltage of diode)

The voltage of the CONT terminal is regulated to  $V_{OUT} + V_D$  voltage.

Change by the time of  $I_L$  that flows to  $V_{OUT}$  through the diode for  $t_{OFF}$  :

$$\frac{dI_L}{dt} = \frac{V_L}{L} = \frac{V_{OUT} + V_D - V_{IN}}{L} \dots\dots\dots (6)$$

Integral of the above equation :

$$I_L = I_{PK} - \left( \frac{V_{OUT} + V_D - V_{IN}}{L} \right) \cdot t \dots\dots\dots (7)$$

In  $t_{ON}$ , energy is accumulated in  $L$  and is not transferred to  $V_{OUT}$ . Capacitor ( $C_{OUT}$ ) energy is used for a load current ( $I_{OUT}$ ). As a result,  $V_{OUT}$  voltage decreases, and this voltage becomes a minimum in  $t_{ON}$ . If M1 is off, the energy accumulated in  $L$  is transferred to  $C_{OUT}$  through the diode, and  $V_{OUT}$  voltage increases rapidly.  $V_{OUT}$  voltage indicates a maximum value (ripple voltage:  $V_{PP}$ ) when the current that flows to  $V_{OUT}$  through the diode matches the constant output current  $I_{OUT}$ .

Then, this ripple voltage value is derived.

$I_{OUT}$  in  $t_1$  which is the time period until  $V_{OUT}$  reaches the maximum value:

$$I_{OUT} = I_{PK} - \left( \frac{V_{OUT} + V_D - V_{IN}}{L} \right) \cdot t_1 \dots\dots\dots (8)$$

$$\therefore t_1 = (I_{PK} - I_{OUT}) \cdot \left( \frac{L}{V_{OUT} + V_D - V_{IN}} \right) \dots\dots\dots (9)$$

Considering  $I_L = 0$  occurs (all inductor energy is transferred) for  $t_{OFF}$ , equation (7) becomes:

$$\left( \frac{L}{V_{OUT} + V_D - V_{IN}} \right) = \frac{t_{OFF}}{I_{PK}} \dots\dots\dots (10)$$

Substituting (10) into (9):

$$t_1 = t_{OFF} - \left( \frac{I_{OUT}}{I_{PK}} \right) \cdot t_{OFF} \dots\dots\dots (11)$$

The amount of charge  $\Delta Q_1$  charged in  $C_{OUT}$  for  $t_1$ :

$$\begin{aligned} \Delta Q_1 &= \int_0^{t_1} I_L dt = I_{PK} \cdot \int_0^{t_1} dt - \frac{V_{OUT} + V_D - V_{IN}}{L} \cdot \int_0^{t_1} t dt \\ &= I_{PK} \cdot t_1 - \frac{V_{OUT} + V_D - V_{IN}}{L} \cdot \frac{1}{2} t_1^2 \dots\dots\dots (12) \end{aligned}$$

Substituting (12) into (9):

$$\Delta Q_1 = I_{PK} - \frac{1}{2} (I_{PK} - I_{OUT}) \cdot t_1 = \frac{I_{PK} + I_{OUT}}{2} \cdot t_1 \dots\dots (13)$$

The voltage ( $V_{PP}$ ) that is raised by  $\Delta Q_1$ :

$$V_{PP} = \frac{\Delta Q_1}{C_{OUT}} = \frac{1}{C_{OUT}} \cdot \left( \frac{I_{PK} + I_{OUT}}{2} \right) \cdot t_1 \dots\dots\dots (14)$$

When  $I_{OUT}$  consumed for  $t_1$  is considered:

$$V_{PP} = \frac{\Delta Q_1}{C_{OUT}} = \frac{1}{C_{OUT}} \cdot \left( \frac{I_{PK} + I_{OUT}}{2} \right) \cdot t_1 - \frac{I_{OUT} \cdot t_1}{C_{OUT}} \dots\dots (15)$$

Substituting (11) into (15):

$$V_{PP} = \frac{(I_{PK} - I_{OUT})^2}{2I_{PK}} \cdot \frac{t_{OFF}}{C_{OUT}} \dots\dots\dots (16)$$

■ **Selection of External Parts**

1. Inductor

To reduce the loss due to the DC resistance, select an inductor with as small a DC resistance as possible (less than 1 Ω). Select the best inductance for the application.

To make the average value of the output voltage ( $V_{OUT}$ ) constant, the inductor must supply energy equivalent to the output current ( $I_{OUT}$ ). The amount of charge required for  $I_{OUT}$  is  $I_{OUT} \times (t_{ON} + t_{OFF})$ . The inductor can supply energy only during  $t_{OFF}$ , thus the amount of charge is obtained as  $I_{PK}/2 \times t_{OFF}$  by integrating equation (7) by  $0 \rightarrow t_{OFF}$ . Therefore:

$$\frac{I_{PK}}{2} \cdot t_{OFF} = I_{OUT} \times (t_{ON} + t_{OFF}) \quad \dots\dots\dots (17)$$

$$\therefore I_{PK} = 2 \cdot \frac{t_{ON} + t_{OFF}}{t_{OFF}} \cdot I_{OUT} \quad \dots\dots\dots (18)$$

Since the oscillation duty ratio of the OSC is 60% and  $I_{PK}$  equals  $5 \times I_{OUT}$ , the  $I_{PK}$  current flowing in the M1 transistor must be five times of  $I_{OUT}$ .  $I_{PK}$  is limited due to the characteristics of the M1 transistor (500 mA max.).

In the S-8435/8436 Series, recommended inductance is as follows depending on the output voltage.

$$V_{OUT} < 2 \text{ V} : L = 100 \text{ to } 820 \mu\text{H}$$

$$V_{OUT} \geq 2 \text{ V} : L = 39 \text{ to } 820 \mu\text{H}$$

Using an inductor with a large L value decreases  $I_{PK}$  and  $I_{OUT}$ . Since the energy accumulated in the inductor is  $1/2 L(I_{PK})^2$ ,  $I_{PK}$  decreases in steps of squares offsetting the increase of L, and the energy decreases overall. Accordingly, stepping up at low voltages is difficult and the lowest operating voltage must be specified as a high value. However, the DC resistance loss in L and the M1 transistor becomes small because of the reduced  $I_{PK}$ , and the efficiency is improved overall (see Figures 5 and 6).

Using an inductor with a small L value increases  $I_{PK}$  and  $I_{OUT}$ . Accordingly, the minimum operating voltage is lowered, but efficiency decreases.

**Note** Too large an  $I_{PK}$  causes magnetic saturation for some core materials, resulting in destruction of the IC chip. Always keep  $I_{sat}$  higher than  $I_{PK}$  ( $I_{sat}$ : level of current that causes magnetic saturation).

Inductance (L) - efficiency ( $\eta$ )

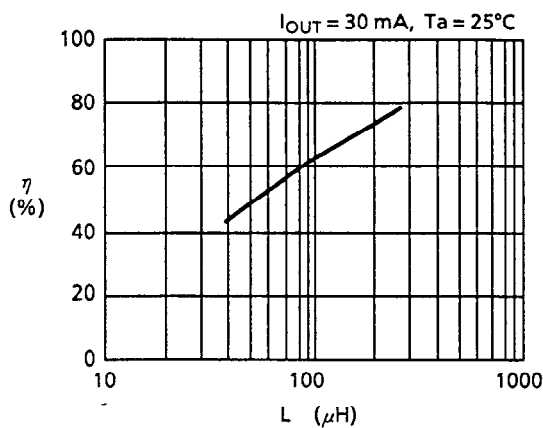

Figure 5

Inductance (L) -

Min. operating supply voltage ( $V_{INMIN}$ )

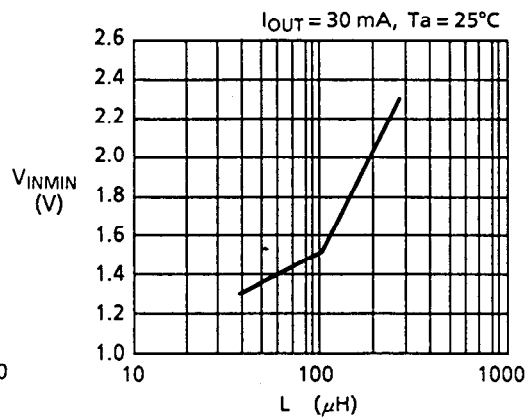

Figure 6

## 2. Diode

Use an external diode that meets the following conditions :

- Low forward voltage ( $V_F < 0.3V$ )
- Fast switching rate (500 ns max.)
- Backward voltage of  $V_{OUT} + V_F$  or more
- Current rating of  $I_{PK}$  or more

The S-8435 Series has a built-in Schottky diode, which has almost the same performance as the 1S1588 diode. To improve the efficiency or obtain over 10 mA of output current, however, use an external Schottky diode.

## 3. Capacitors ( $C_{IN}$ and $C_{OUT}$ )

The input capacitor ( $C_{IN}$ ) reduces power source impedance and stabilize the input current to improve the efficiency. Select a  $C_{IN}$  value depending on the impedance of the power source used. The capacitor value is 10  $\mu F$  min.

Select a large output capacitor ( $C_{OUT}$ ) with small electric series resistance (ESR) for reducing ripple voltage. Its capacitor value is 22  $\mu F$  min. A tantalum electrolytic capacitor or an organic semiconductor capacitor is recommended to be used because of their excellent low temperature and leakage current characteristics.

## 4. External transistor (S-8436 series)

The S-8436 series increases the output current with an external transistor. An external bipolar transistor or an external enhancement MOS FET transistor can be used.

### 4.1 Bipolar transistor

Figure 7 is an example of the circuit (S-8436 series) that uses Toshiba 2SC3279 as the bipolar transistor (NPN). An  $R_b$  value determines the driving force to increase the output current using the bipolar transistor. Figure 8 is an example of the peripheral circuit required to determine the  $R_b$  value.

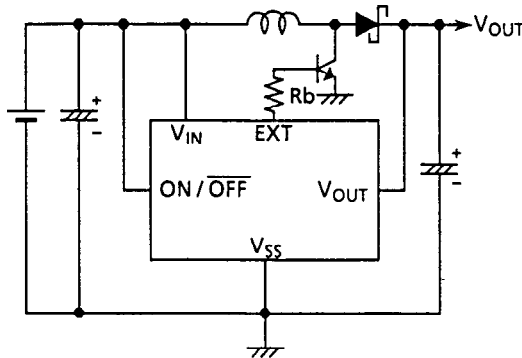

Figure 7 Circuit example with 2SC3279

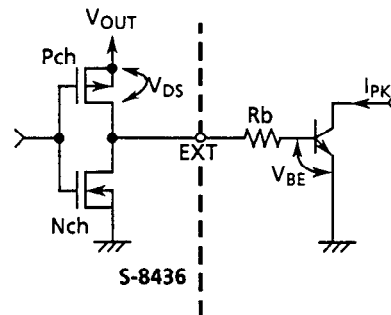

Figure 8 Peripheral circuit of external transistor

The  $R_b$  value is calculated by the following equation, because the base current of the external transistor is supplied from the  $V_{OUT}$  terminal, as shown in Figure 8. The current has a pulse-like flow or the voltage may drop by wiring resistance, however, always find the optimum value with an experiment. For the S-8436CF with the  $R_b$  value from 100 to 750  $\Omega$ , its step-up capability characteristics do not show much difference. 300  $\Omega$  is recommended. Find  $V_{DS}$  from the characteristics graphs shown in Figures 9 and 10.

$$V_{OUT} = V_{DS} + R_b \cdot \frac{1}{\beta} \cdot I_{PK} + V_{BE}$$

$$(V_{BE} \approx 0.7 \text{ V}, I_{PK} \approx 5 \cdot I_{OUT}, \beta : \text{Common emitter forward current gain})$$

**STEP-UP SWITCHING REGULATORS**  
**S-8435/8436 Series**

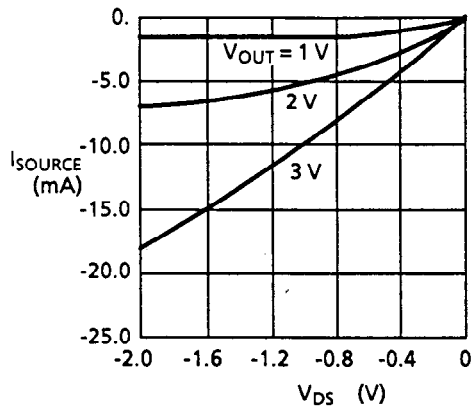

Figure 9 Source current of Pch transistor

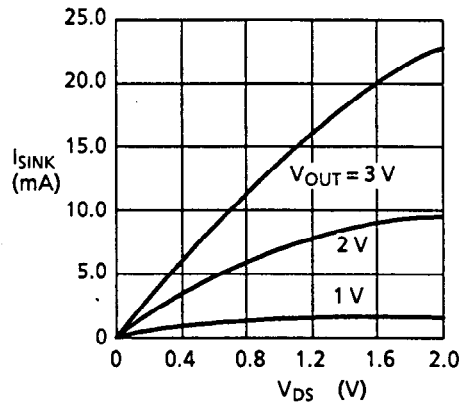
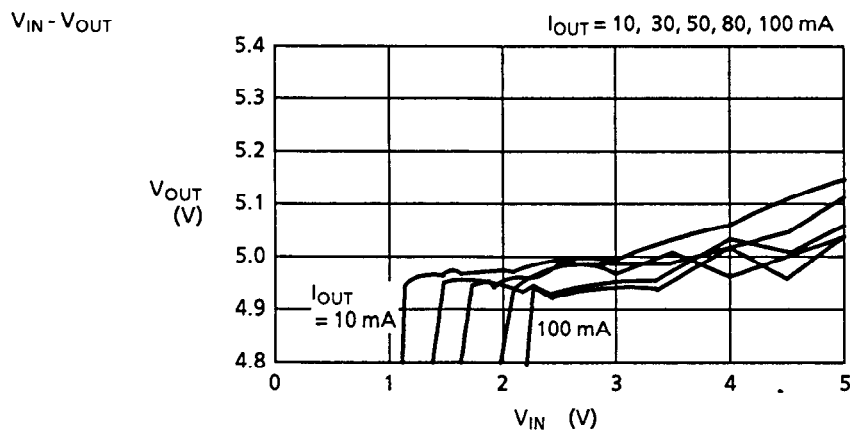
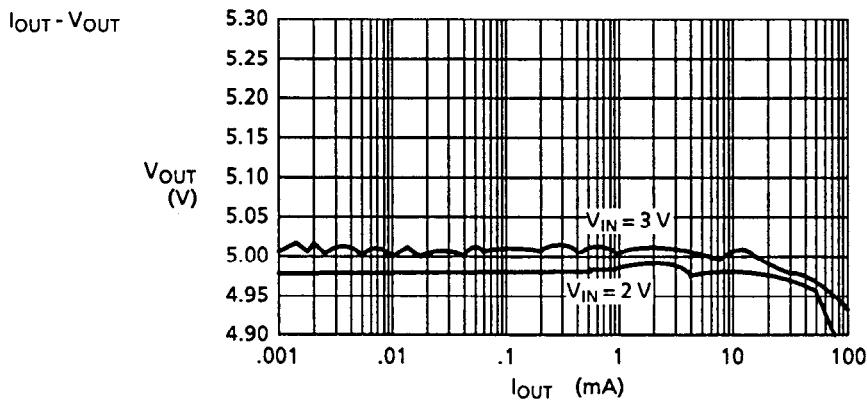

Figure 10 Sink current of Nch transistor

Characteristics example: When S-8436CF, Tr = 2SC3279 is used, and  $T_a = 25^\circ\text{C}$

(1)  $R_b = 100\ \Omega$



(2)  $R_b = 750\ \Omega$

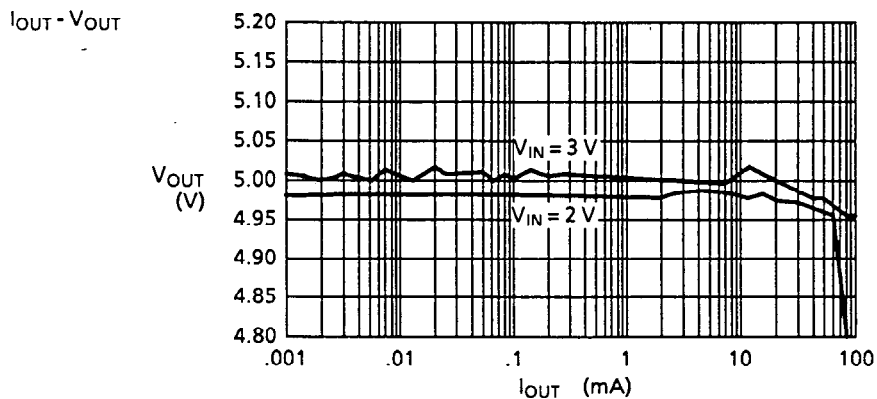

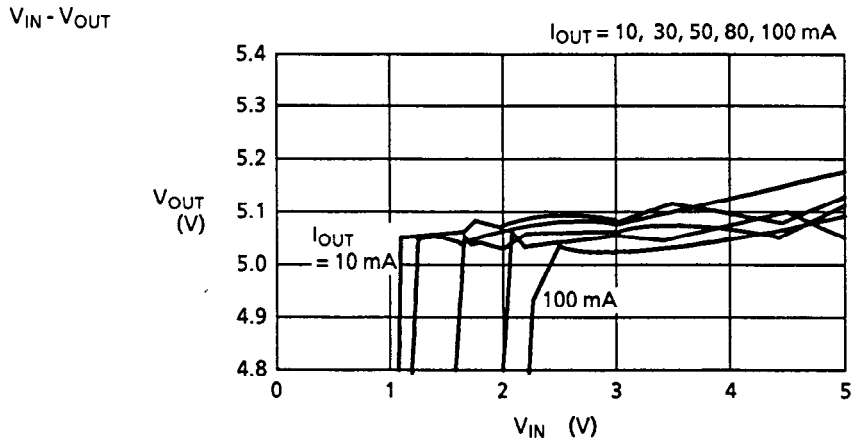

#### 4.2 Enhancement MOS FET

Figure 11 is the circuit example (S-8436 series) that uses Toshiba 2SK1112 as the MOS FET (Nch). Always use Nch power MOS FET. In particular, the EXT terminal of the S-8436 series drives the MOS FET with a gate of about 1000 pF. The MOS FET is driven more effectively because the gate voltage and current of the external power MOS FET are supplied from stepped-up output voltage  $V_{OUT}$ .

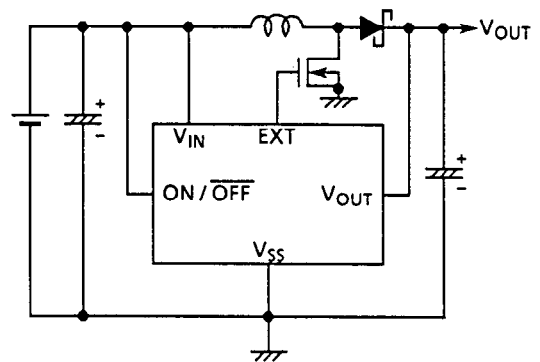

Figure 11 Example of circuit using 2SK1112

The threshold voltage must be low because MOS FET ON resistance affects the output current and efficiency. When the output voltage is low (1.5 V), such as in S-8436AF, the circuit does not work unless the threshold voltage of MOS FET has less than 1.5 V.

#### ■ Standard Circuits (S-8435 Series)

In the S-8436 series, the standard circuit is an example of the circuit shown in "External transistor" in the chapter for selecting external parts.

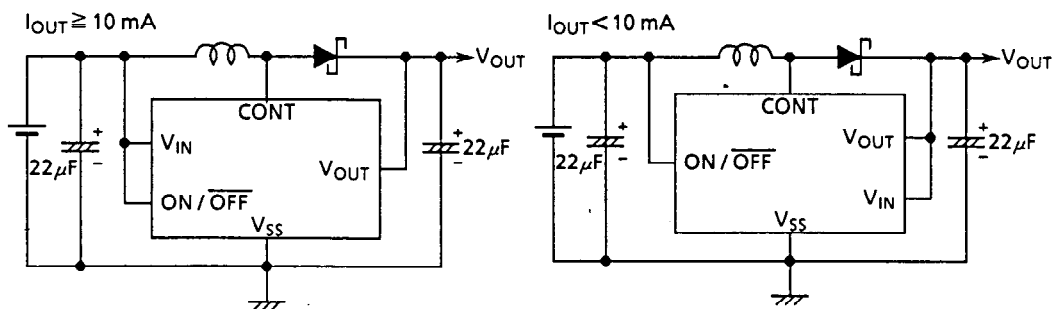

Figure 12

Figure 13

The difference between Figures 12 and 13 is a  $V_{IN}$  connection. The connection to be used depends on the purpose. The connection shown in Figure 12 is suitable for high output current ( $\geq 10 \text{ mA}$ ). The connection shown in Figure 13 is suitable for low output current ( $I_{OUT} < 10 \text{ mA}$ ) because minimum operating supply voltages is reduced. (See the supply voltage-output voltage characteristics on the next page. Use RCH855-47  $\mu\text{H}$  manufactured by Sumida Electric for the coils and D1NS4 for the external diode.)



# STEP-UP SWITCHING REGULATORS

## S-8435/8436 Series

(1) In case of  $V_{IN}$  up sequence (step-up characteristics when supply voltage is increased)

$V_{IN} \neq V_{OUT}$  (in the circuit shown in Figure 12)

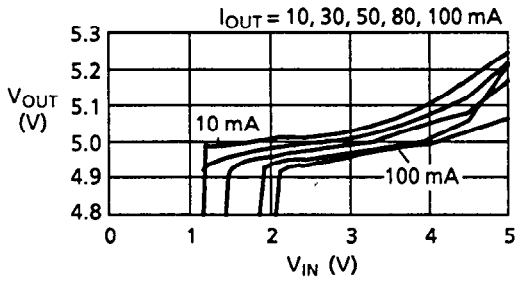

$V_{IN} = V_{OUT}$  (in the circuit shown in Figure 13)

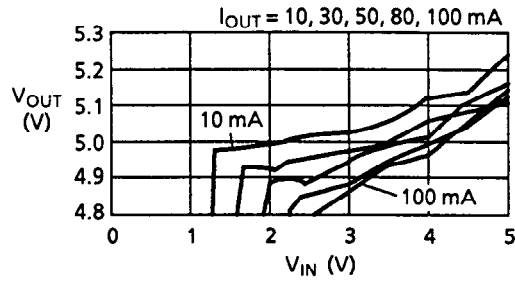

(2) In case of  $V_{IN}$  down sequence (step-up characteristics when supply voltage is decreased)

$V_{IN} \neq V_{OUT}$  (in the circuit shown in Figure 12)

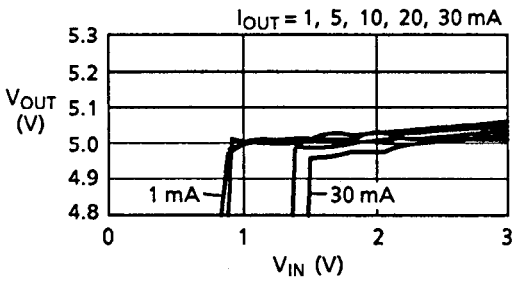

$V_{IN} = V_{OUT}$  (in the circuit shown in Figure 13)

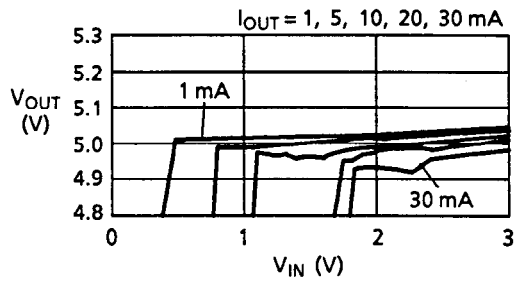

### Application Circuits

#### 1.1 cell backup circuit (S-8435BF)

Backup battery voltage is reduced from 3 V to 1.5 V (from 2 cells to 1 cell).

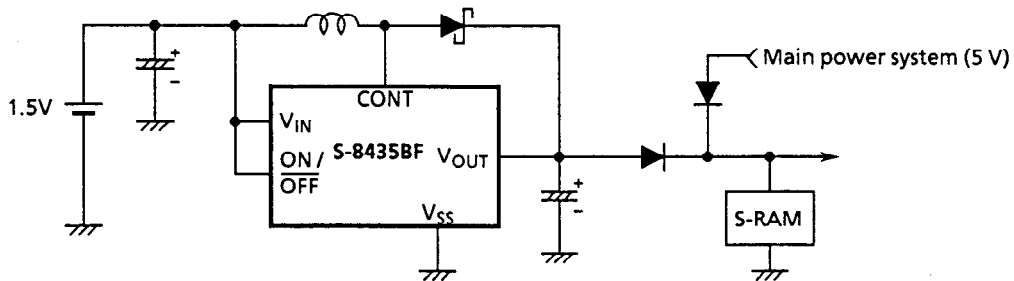

Figure 14

#### 2. Switching 5 V and backup power supplies

The S-8435/8436 Series has a shutdown function.  $V_{OUT}$  is  $V_{IN}-0.6$  V for shutdown status. This voltage enables to backup a microcomputer with a low current consumption.

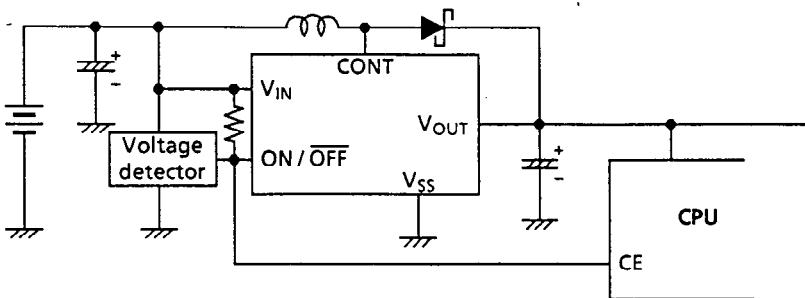

Figure 15

3. Circuit for increasing output voltage

3.1 S-8435 series

When increasing the output voltage in the S-8435 series, efficiency can be kept high by mounting resistors between CONT and  $V_{IN}$  terminals.

Supply voltage to  $V_{OUT}$  terminal by mounting an NPN transistor and a capacitor C1 because some blocks of the S-8435 series are powered from  $V_{OUT}$  terminal. In addition, connect a schottky diode D1 between  $V_{IN}$  and  $V_{OUT}$  terminals in order to start step-up operation at low voltage.

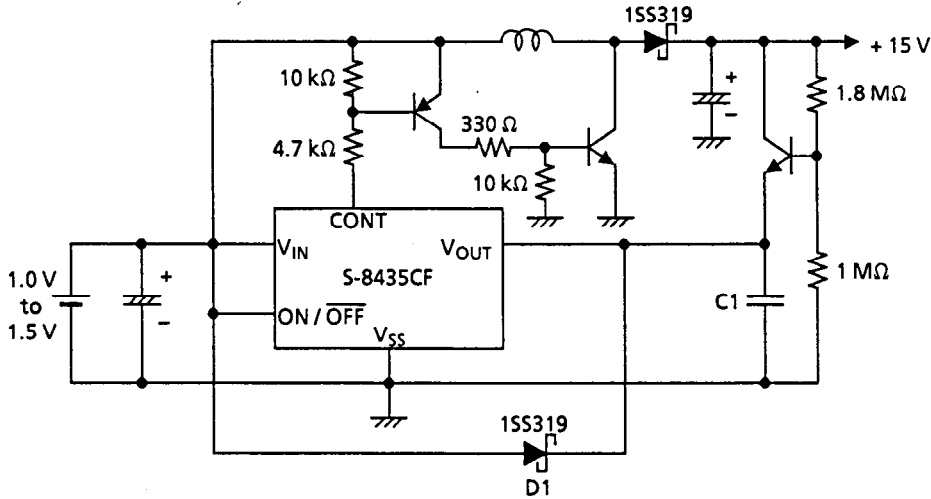

Figure 16

3.2 S-8436 series

In Figure 17, +12 V output voltage is obtained by mounting an external  $R_A$  and  $R_B$  resistors with S-8436CF.

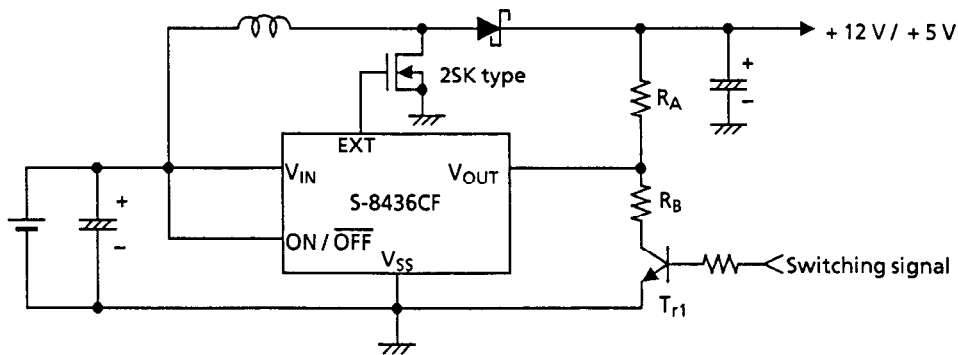

Figure 17

+12 V/+5 V is switched by inserting  $T_{r1}$ . In this case, set resistors  $R_A$  and  $R_B$  to about 10 k $\Omega$ . For example, +12 V output is obtained at  $R_A = 14$  k $\Omega$  and  $R_B = 10$  k $\Omega$ . Use the enhancement Nch MOS FET for the external transistor.<sup>2</sup>

■ **Notes on Design**

- When the built-in schottky diode is used in the S-8435 series, the output current shall be 10 mA or less.
- Set 10  $\mu\text{F}$  min. for the input capacitor ( $C_{\text{IN}}$ ) connected to  $V_{\text{IN}}$ .
- The peak current (500 mA) of the built-in power MOS FET must not be exceeded.
- Install external parts as close as possible to the IC, and make ground line well-built.
- The switching regulator causes ripple voltages and spike noises. To implement a design using the S-8435/8436, evaluate the performance with the actual board.
- Do not apply a supply voltage of less than 0.9 V at  $V_{\text{IN}}$  in the standard circuit shown in Figure 12. If a voltage of less than that is applied, the input current may increase rapidly. The input current may increase rapidly in the application of a low supply voltage and a low load current ( $I_{\text{OUT}}=20 \mu\text{A}$ ) when the S-8436 series is used.
- When the shutdown terminal is connected to the  $V_{\text{IN}}$  terminal, confirm that the deviation of  $V_{\text{IN}}$  terminal voltage is not lower than the  $V_{\text{SL}}$  level. If the deviation is lower than that level, insert a CR filter circuit into the shutdown terminal, as shown in Figure 18. Also when the shutdown terminal is connected to the  $V_{\text{OUT}}$  terminal, the IC may not work (step-up) because of voltage drop by coil and diode at power-on. So, when using with  $V_{\text{OUT}} = \text{ON/OFF}$ , apply a sufficient high supply voltage.

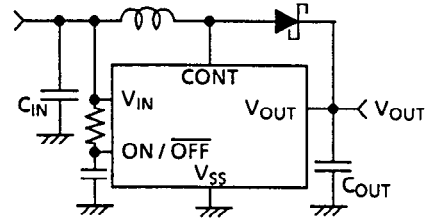

Figure 18

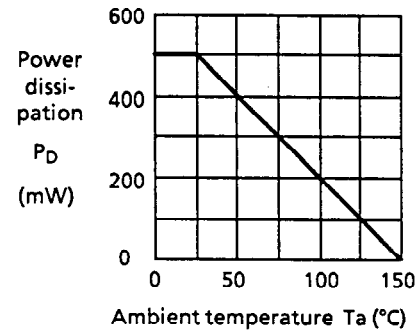

Figure 19 Package power dissipation (before mounting)

- Take short-circuiting and overheating into consideration when designing because no short-circuit protection or thermal shutdown circuits are loaded in the S-8435/8436 series.

■ **Dimensions**

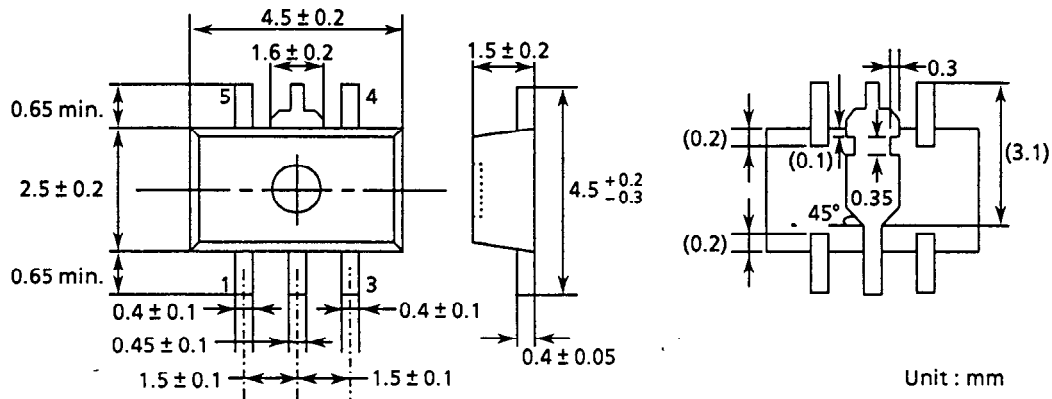
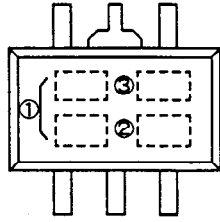

Figure 20

■ Markings



- ① : Product name (abbreviation)
- ② : Month of assembly
- ③ : Week of assembly

Figure 21

■ Taping

1. Tape specifications

T1 and T2 types are available depending upon the direction of ICs on the tape.

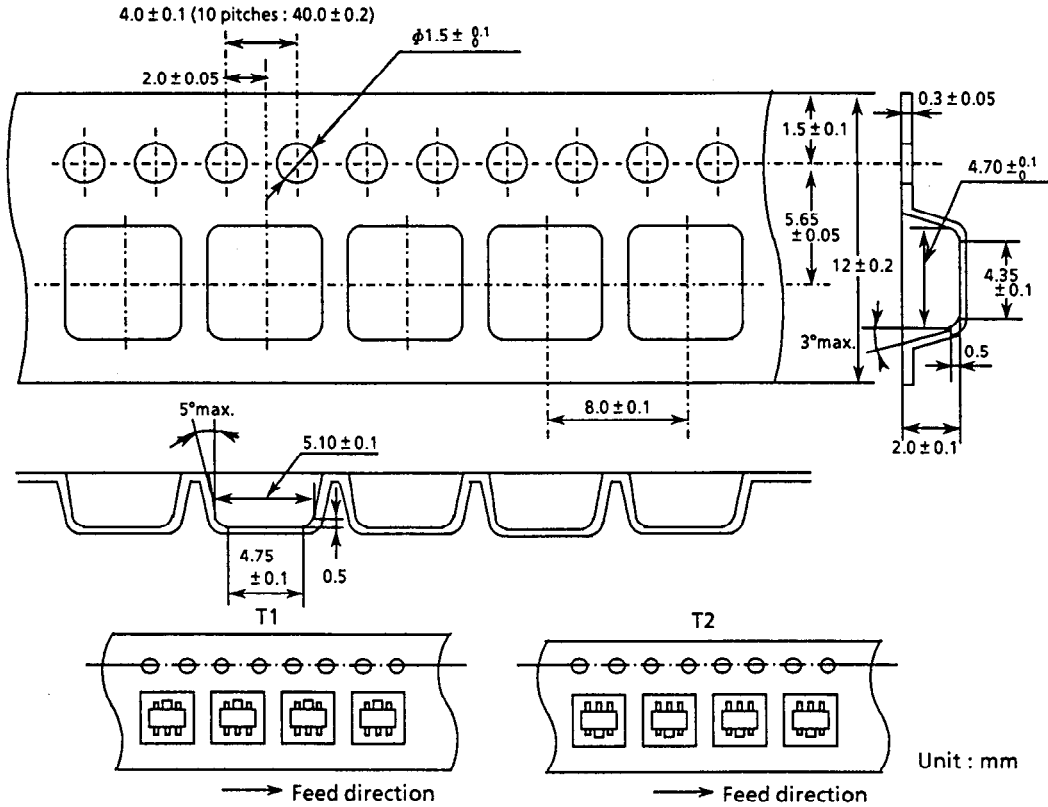

Unit : mm

Figure 22

2. Reel specifications

1 reel holds 1000 regulators.

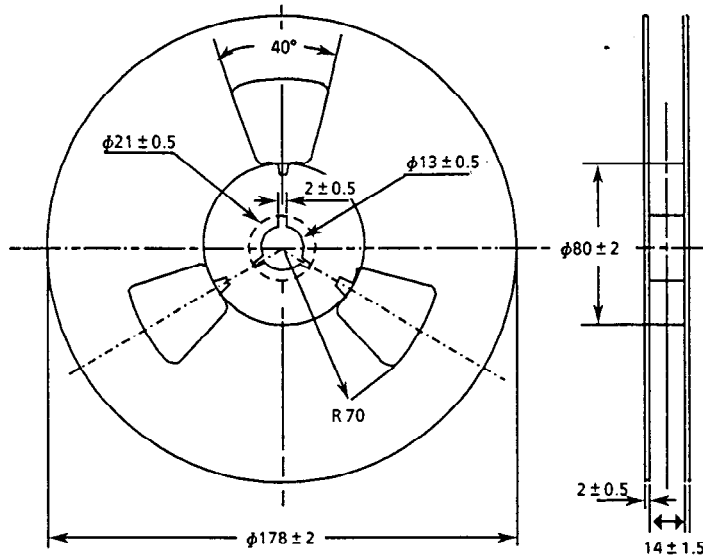

Unit : mm

Figure 23

■ **Characteristics**

1. Oscillating frequency - Ambient temperature

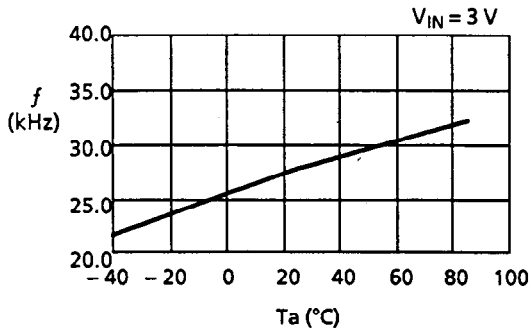

2. Line regulation - Ambient temperature

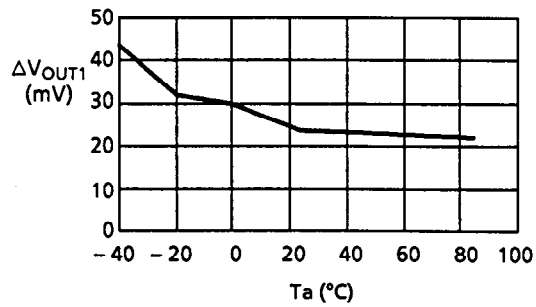

3. Load regulation - Ambient temperature

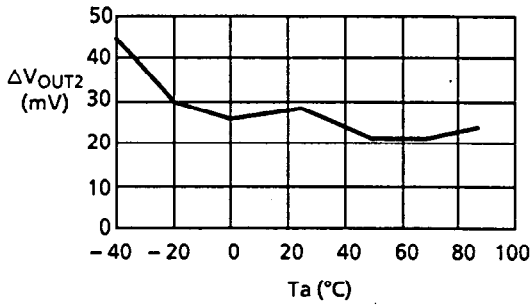

4. Output voltage - Ambient temperature

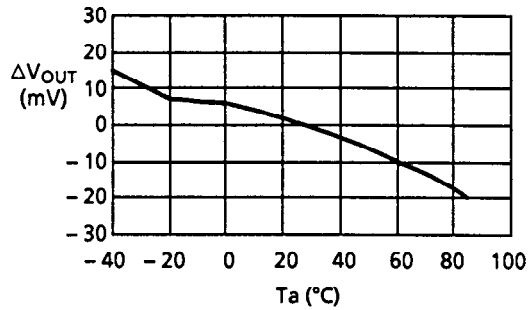

ΔVOUT : Difference between output voltage and output voltage at 25°C

5. Supply voltage - Current consumption

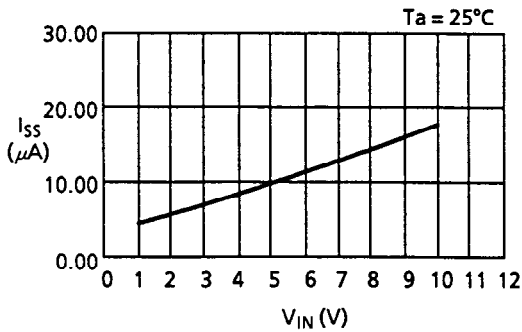

6. Current consumption - Ambient temperature

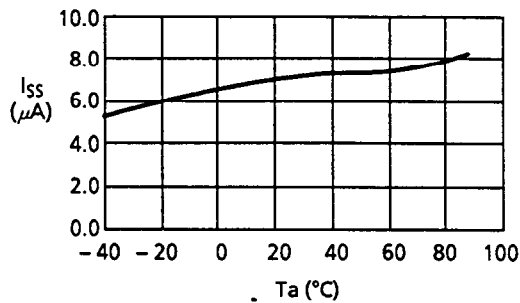

7. Oscillation start voltage - Ambient temperature

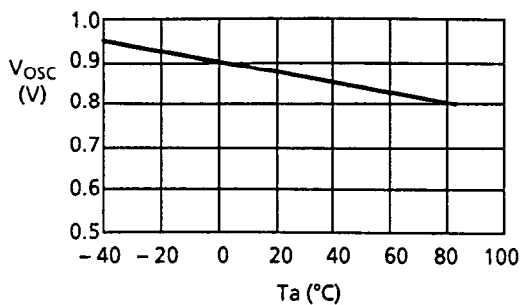

8. Forward voltage - Forward current (built-in schottky diode)

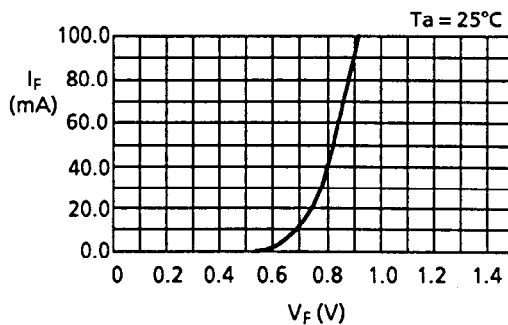

9. Output voltage - Output current

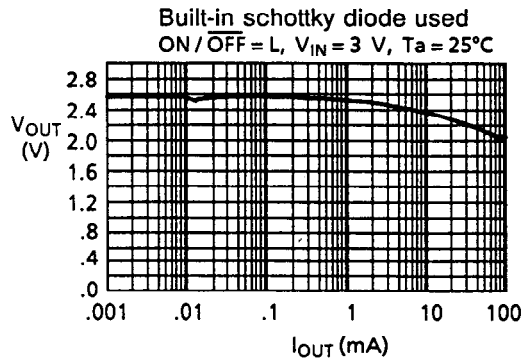

10. Supply voltage - Supply voltage (power-off terminal)

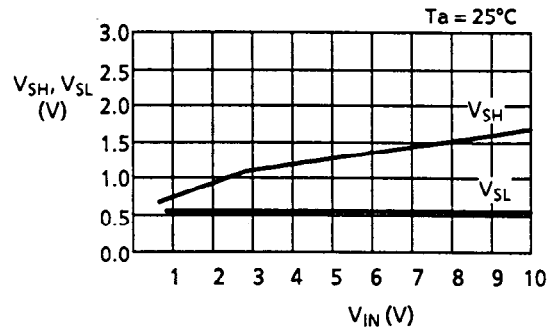

$V_{SH}$  : Minimum voltage value recognized as high  
 $V_{SL}$  : Maximum voltage value recognized as low

11. Ripple voltage characteristics

11.1  $C_{OUT}$  dependence

Ripple voltage is decreased by increasing the  $C_{OUT}$  capacitor value.

(a)  $C_{OUT} = 69\ \mu\text{F}$   $L = 47\ \mu\text{H}$  (RCH855)

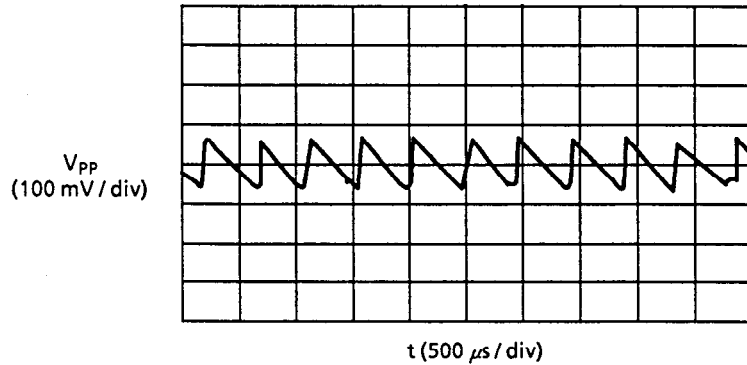

(b)  $C_{OUT} = 47\ \mu\text{F}$   $L = 47\ \mu\text{H}$  (RCH855)

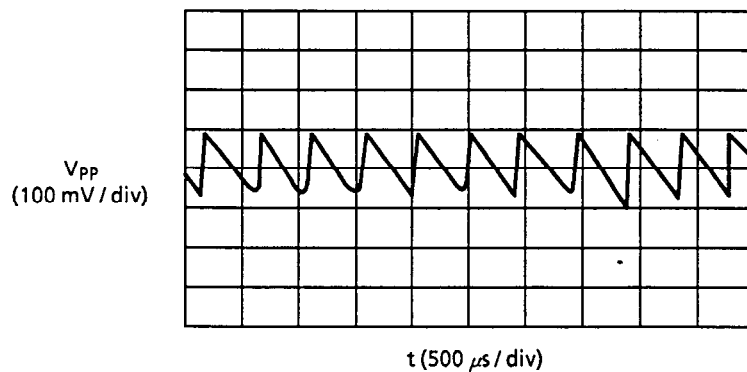

(c)  $C_{OUT} = 22\ \mu\text{F}$   $L = 47\ \mu\text{H}$  (RCH855)

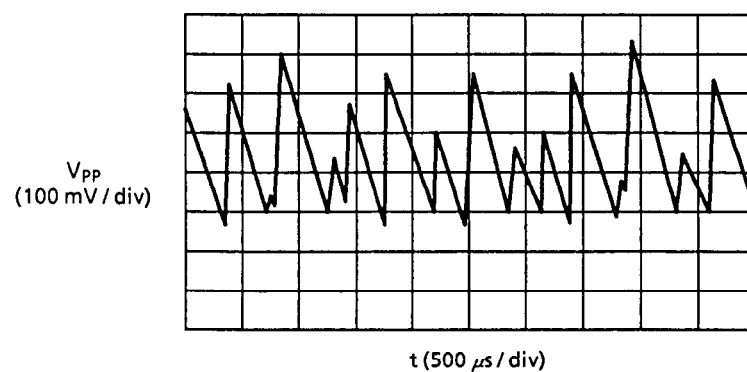

11.2 Coil dependence

Ripple voltage is also decreased by increasing the coil inductance.

(a)  $L = 47 \mu\text{H}$  (NLC453232),  $C_{\text{OUT}} = 47 \mu\text{F}$ ,  $T_a = 25^\circ\text{C}$

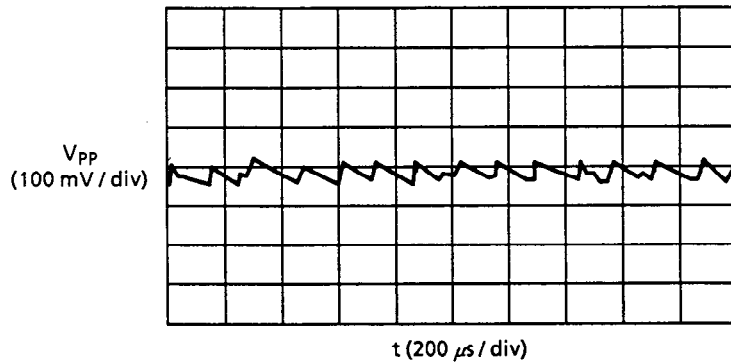

(b)  $L = 100 \mu\text{H}$  (NL453232),  $C_{\text{OUT}} = 47 \mu\text{F}$ ,  $T_a = 25^\circ\text{C}$

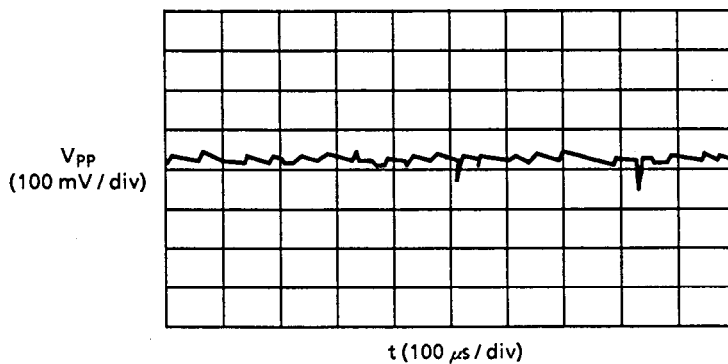

12. Transient response characteristics

Sample : S-8435CF

Coil: NLC453232 (TDK), diode : D1NS4 (Shindengen)

12.1 Line transient ( $T_a = 25^\circ\text{C}$ )

(a)  $V_{\text{IN}} = 7 \rightarrow 2 \text{ V}$ ,  $I_{\text{OUT}} = 30 \text{ mA}$ ,  $C_{\text{OUT}} = 47 \mu\text{F}$ ,  $L = 47 \mu\text{H}$

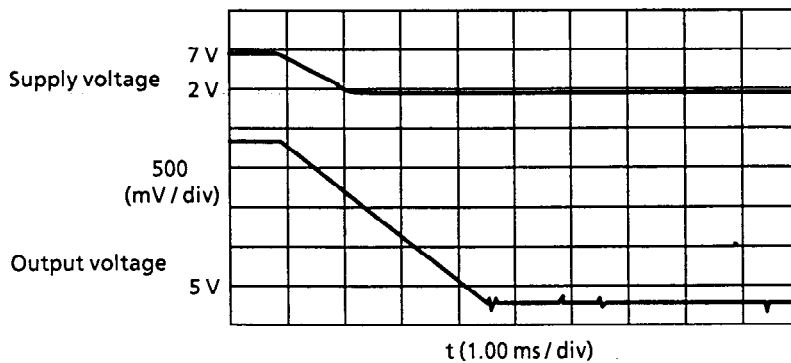

(b)  $V_{\text{IN}} = 2 \rightarrow 7 \text{ V}$ ,  $I_{\text{OUT}} = 30 \text{ mA}$ ,  $C_{\text{OUT}} = 47 \mu\text{F}$ ,  $L = 47 \mu\text{H}$

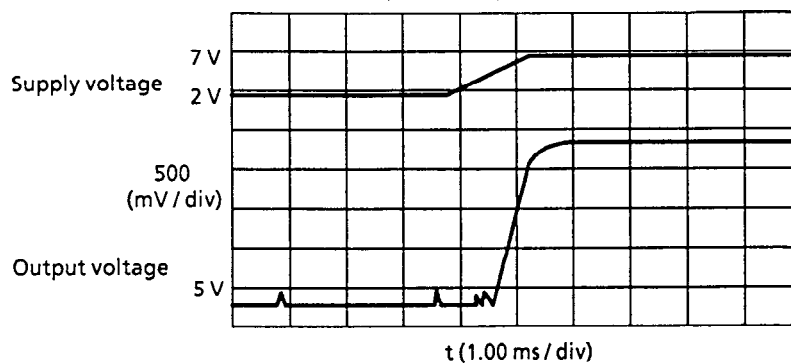

(c)  $V_{IN} = 7 \rightarrow 2$  V,  $I_{OUT} = 30$  mA,  $C_{OUT} = 22$   $\mu$ F,  $L = 47$   $\mu$ H

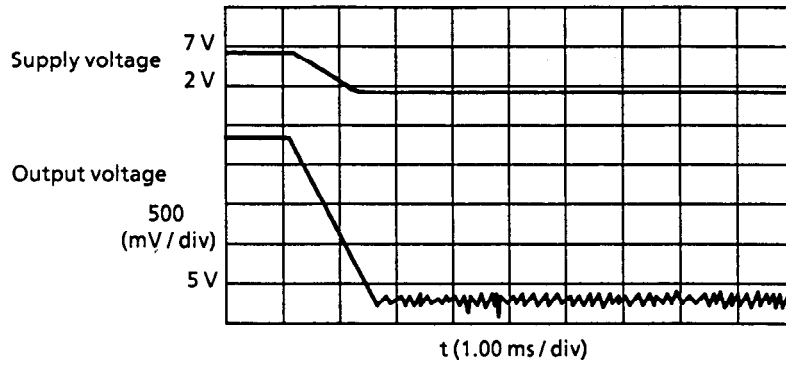

(d)  $V_{IN} = 2 \rightarrow 7$  V,  $I_{OUT} = 30$  mA,  $C_{OUT} = 22$   $\mu$ F,  $L = 47$   $\mu$ H

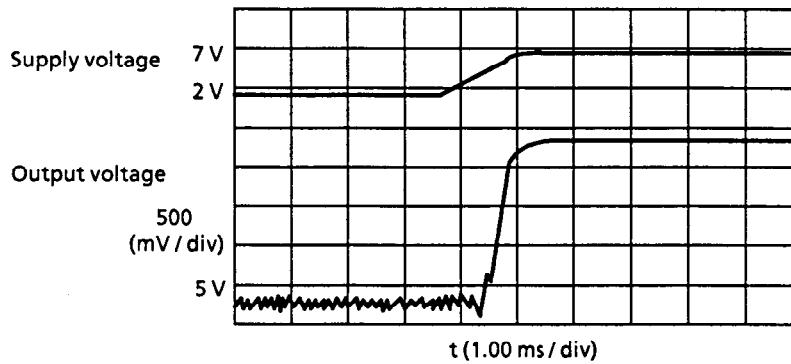

(e)  $V_{IN} = 1.5 \rightarrow 3$  V,  $I_{OUT} = 10$  mA,  $C_{OUT} = 47$   $\mu$ F,  $L = 47$   $\mu$ H

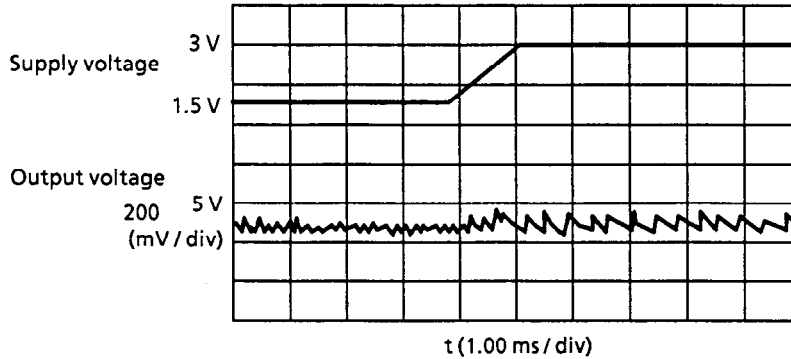

(f)  $V_{IN} = 3 \rightarrow 1.5$  V,  $I_{OUT} = 10$  mA,  $C_{OUT} = 47$   $\mu$ F,  $L = 47$   $\mu$ H

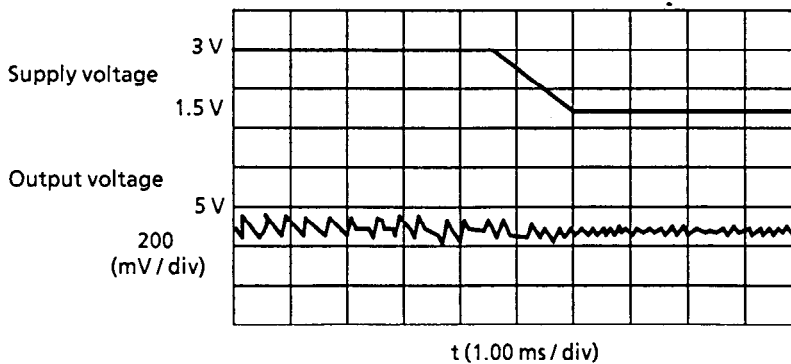



**STEP-UP SWITCHING REGULATORS**  
**S-8435/8436 Series**

(g)  $V_{IN} = 1.5 \rightarrow 3$  V,  $I_{OUT} = 10$  mA,  $C_{OUT} = 22$   $\mu$ F,  $L = 47$   $\mu$ H

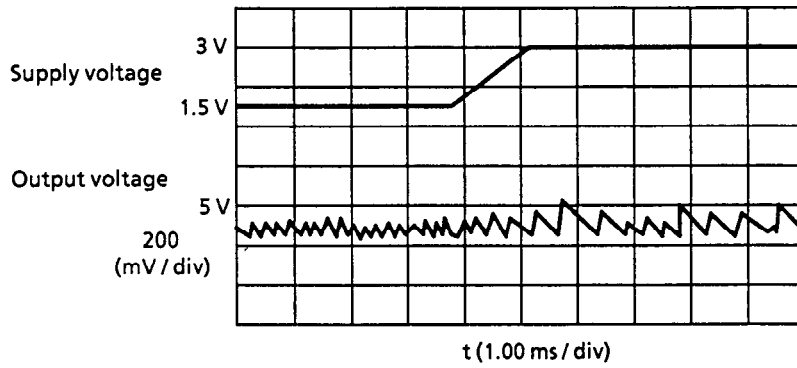

(h)  $V_{IN} = 3 \rightarrow 1.5$  V,  $I_{OUT} = 10$  mA,  $C_{OUT} = 22$   $\mu$ F,  $L = 47$   $\mu$ H

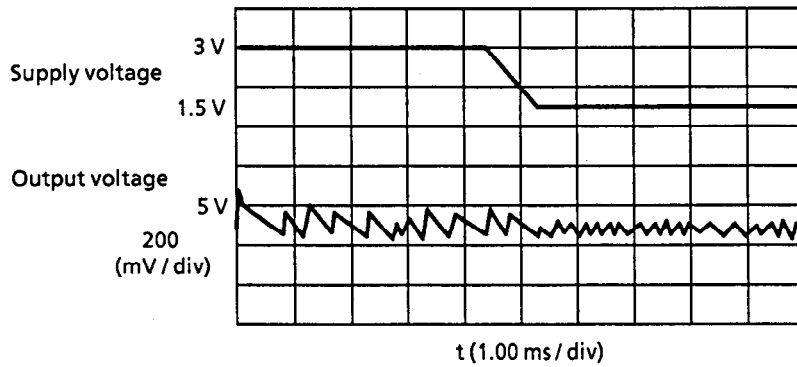

**12.2 Output current transient ( $T_a = 25$  °C)**

(a)  $V_{IN} = 3$  V,  $I_{OUT} = 30$  mA  $\rightarrow$  5  $\mu$ A,  $C_{OUT} = 47$   $\mu$ F,  $L = 47$   $\mu$ H

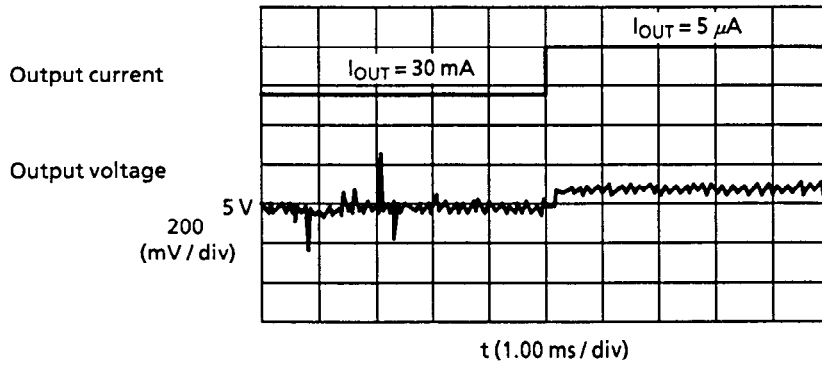

(b)  $V_{IN} = 3$  V,  $I_{OUT} = 5$   $\mu$ A  $\rightarrow$  30 mA,  $C_{OUT} = 47$   $\mu$ F,  $L = 47$   $\mu$ H

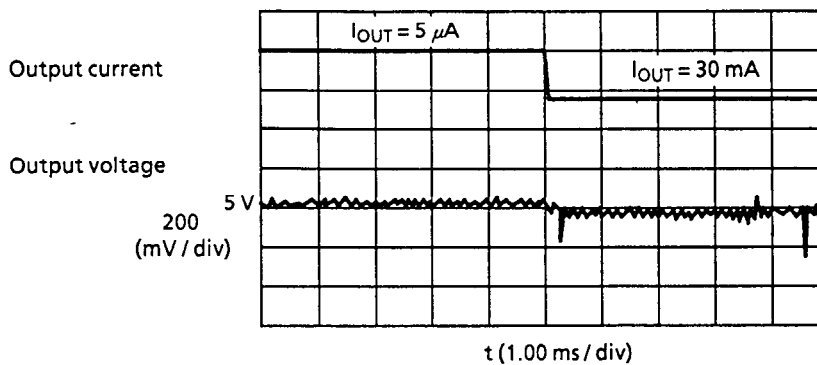

(c)  $V_{IN}=3\text{ V}$ ,  $I_{OUT}=5\ \mu\text{A}\leftrightarrow 30\text{ mA}$ ,  $C_{OUT}=22\ \mu\text{F}$ ,  $L=47\ \mu\text{H}$

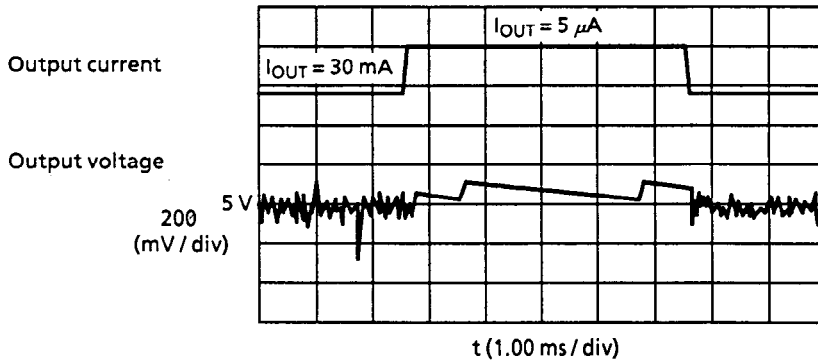

### 12.3 Shutdown terminal response characteristics ( $T_a = 25^\circ\text{C}$ )

(a)  $V_{IN}=3\text{ V}$ ,  $I_{OUT}=30\text{ mA}$ ,  $C_{OUT}=47\ \mu\text{F}$ ,  $\text{ON}/\overline{\text{OFF}}=5\rightarrow 0\text{ V}$ ,  $L=47\ \mu\text{H}$

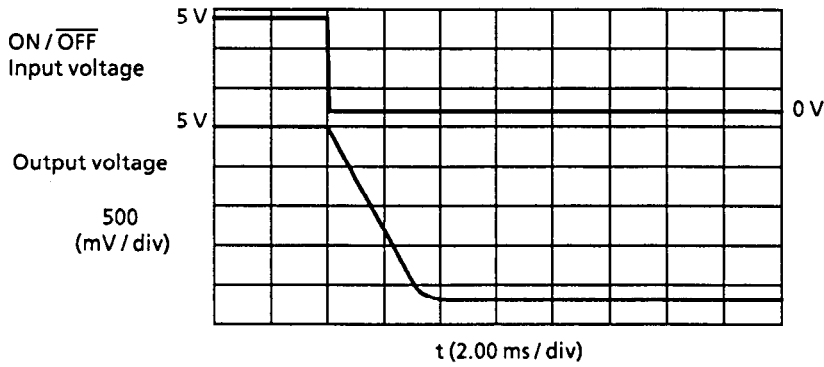

(b)  $V_{IN}=3\text{ V}$ ,  $I_{OUT}=30\text{ mA}$ ,  $C_{OUT}=47\ \mu\text{F}$ ,  $\text{ON}/\overline{\text{OFF}}=5\rightarrow 0\text{ V}$ ,  $L=47\ \mu\text{H}$

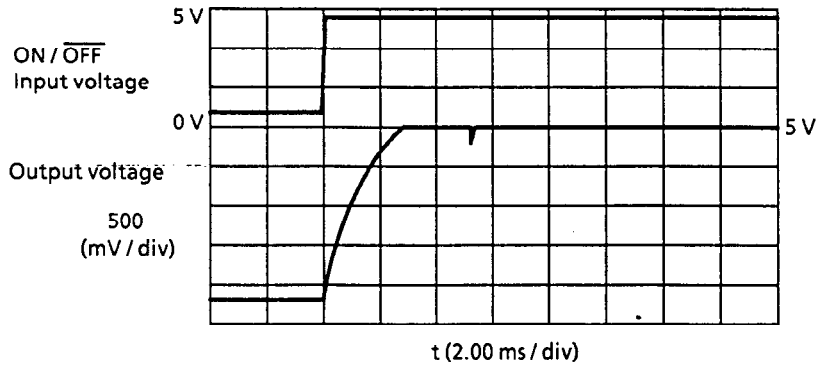

(c)  $V_{IN}=3\text{ V}$ ,  $I_{OUT}=10\text{ mA}$ ,  $C_{OUT}=47\ \mu\text{F}$ ,  $\text{ON}/\overline{\text{OFF}}=0\rightarrow 5\text{ V}$ ,  $L=47\ \mu\text{H}$

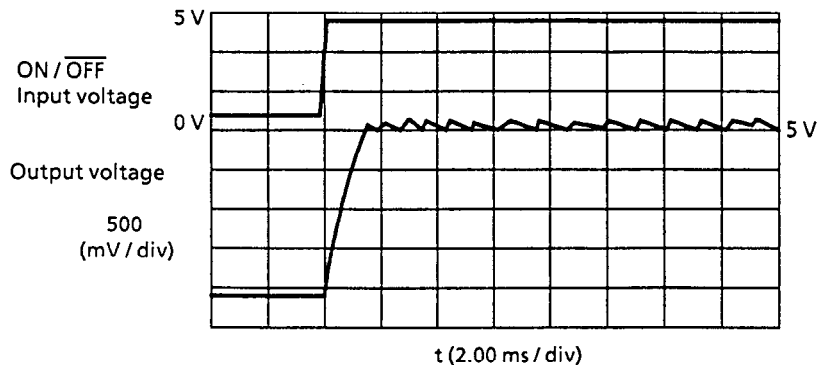

# STEP-UP SWITCHING REGULATORS

## S-8435/8436 Series

(d)  $V_{IN} = 3\text{ V}$ ,  $I_{OUT} = 10\text{ mA}$ ,  $C_{OUT} = 47\text{ }\mu\text{F}$ ,  $\text{ON} / \overline{\text{OFF}} = 5 \rightarrow 0\text{ V}$ ,  $L = 47\text{ }\mu\text{H}$

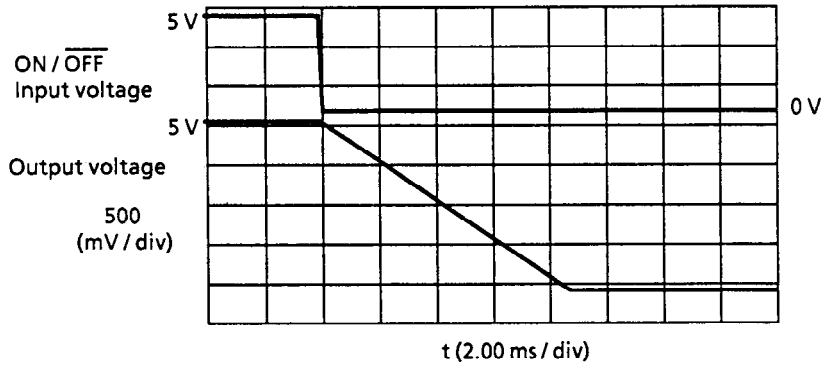

### Reference Data

Characteristics are shown on the next and subsequent pages for when the coils listed in the table below are as reference data:

Evaluation coils

Model No.	Manufacturer	Value L	DC resistance value
RCH855	Sumida Electronics	820 $\mu\text{H}$	3.82 $\Omega$
RCH654	Sumida Electronics	39 $\mu\text{H}$	0.29 $\Omega$
RCH654	Sumida Electronics	47 $\mu\text{H}$	0.34 $\Omega$
RCH654	Sumida Electronics	100 $\mu\text{H}$	0.68 $\Omega$
RCH654	Sumida Electronics	270 $\mu\text{H}$	1.55 $\Omega$
RCH654	Sumida Electronics	470 $\mu\text{H}$	2.92 $\Omega$
FL5H101K	Taiyoyuden	100 $\mu\text{H}$	1.45 $\Omega$
NLC453232	TDK	47 $\mu\text{H}$	1.9 $\Omega$
NL453232	TDK	100 $\mu\text{H}$	8 $\Omega$

D1NS4 of Shindengen is for all the external schottky diodes.

### [ I ] S-8435 Series

1. S-8435AF ( $C_{OUT} = 69\text{ }\mu\text{F}$ )

1.1 RCH855 ( $L = 820\text{ }\mu\text{H}$ ), D1NS4,  $T_a = 25^\circ\text{C}$

(a)  $I_{OUT}$ - $V_{OUT}$

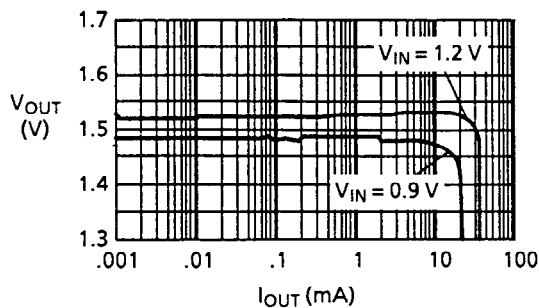

(b)  $V_{IN}$ - $V_{OUT}$

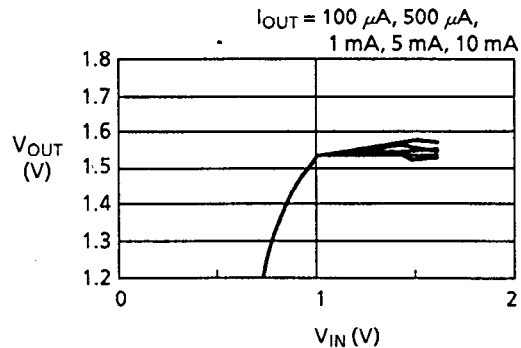

1.2 RCH654 (L = 470  $\mu$ H), D1NS4, Ta = 25°C

(a)  $I_{OUT}$ - $V_{OUT}$

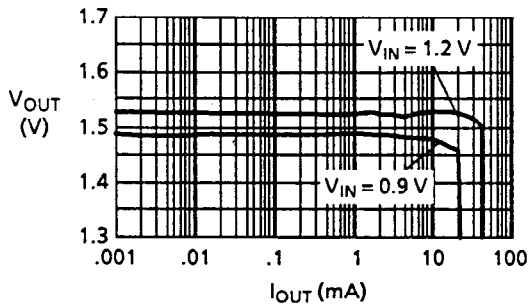

(b)  $V_{IN}$ - $V_{OUT}$

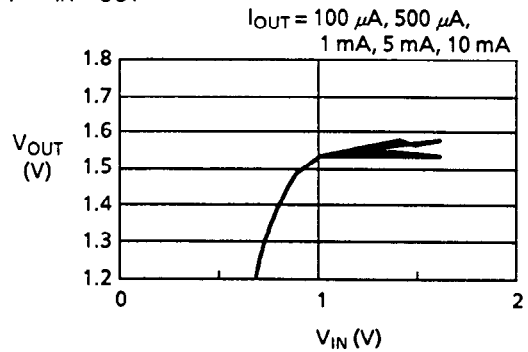

1.3 RCH654 (L = 270  $\mu$ H), D1NS4, Ta = 25°C

(a)  $I_{OUT}$ - $V_{OUT}$

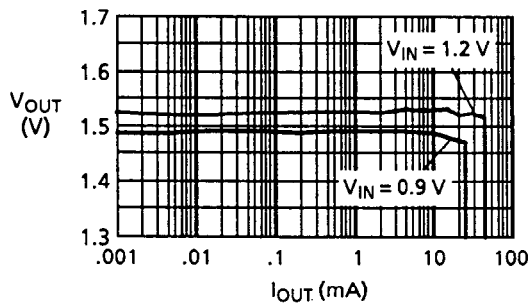

(b)  $V_{IN}$ - $V_{OUT}$

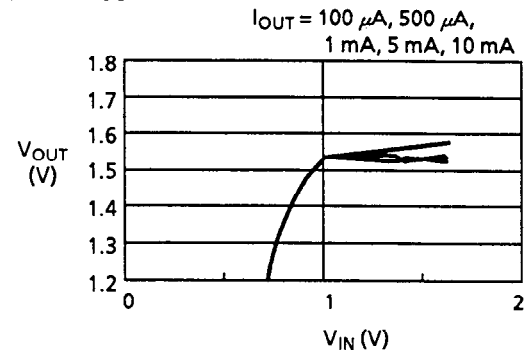

1.4 RCH855 (L = 100  $\mu$ H), D1NS4, Ta = 25°C

(a)  $I_{OUT}$ - $V_{OUT}$

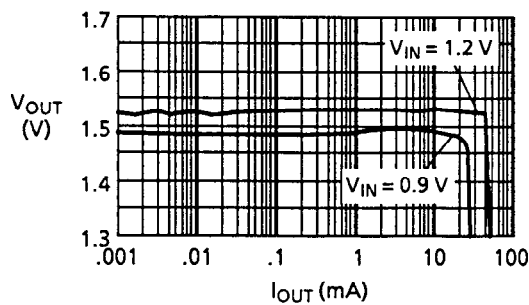

(b)  $V_{IN}$ - $V_{OUT}$

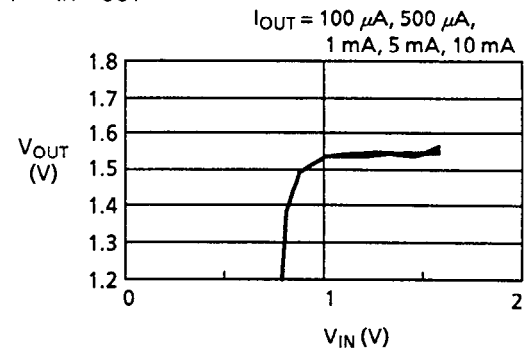

1.5 NL453232 (L = 100  $\mu$ H), D1NS4, Ta = 25°C

(a)  $I_{OUT}$ - $V_{OUT}$

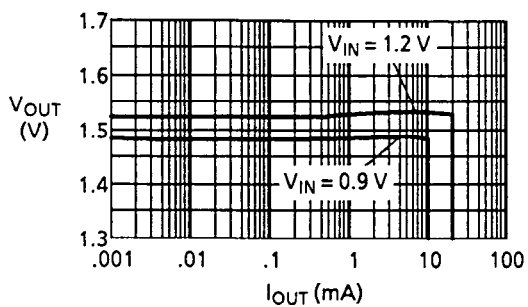

(b)  $V_{IN}$ - $V_{OUT}$

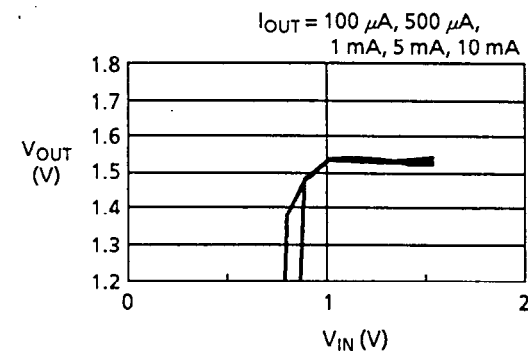

**STEP-UP SWITCHING REGULATORS**  
**S-8435/8436 Series**

2. S-8435BF ( $C_{OUT} = 47 \mu F$ )

2.1 RCH654 ( $L = 39 \mu H$ ), D1NS4,  $T_a = 25^\circ C$

(a)  $I_{OUT}$ - $V_{OUT}$

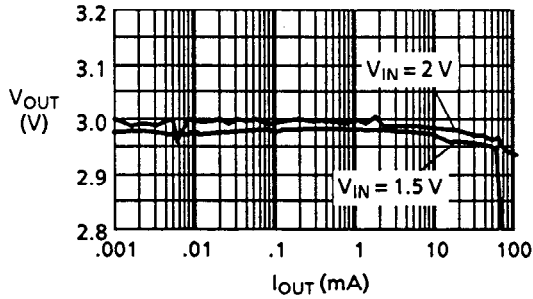

(b)  $V_{IN}$ - $V_{OUT}$

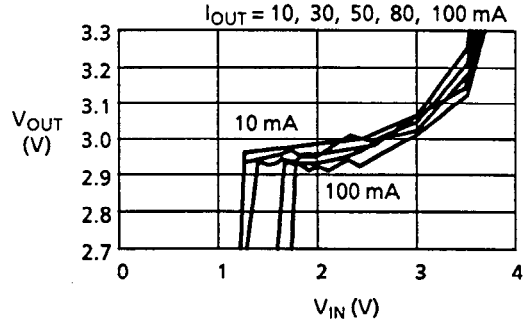

2.2 RCH654 ( $L = 100 \mu H$ ), D1NS4,  $T_a = 25^\circ C$

(a)  $I_{OUT}$ - $V_{OUT}$

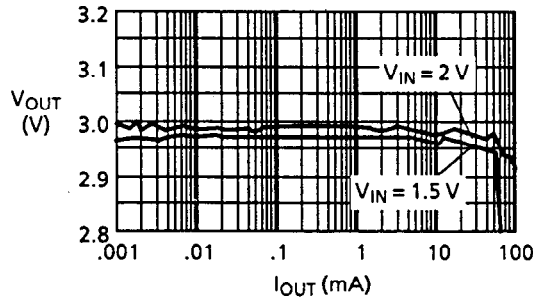

(b)  $V_{IN}$ - $V_{OUT}$

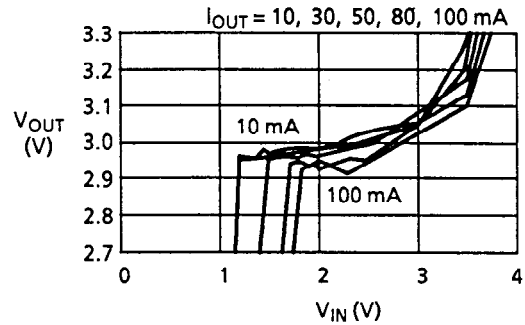

2.3 RCH654 ( $L = 270 \mu H$ ), D1NS4,  $T_a = 25^\circ C$

(a)  $I_{OUT}$ - $V_{OUT}$

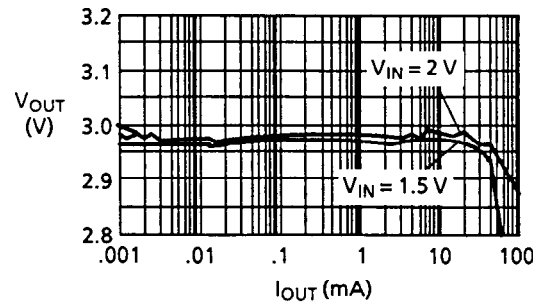

(b)  $V_{IN}$ - $V_{OUT}$

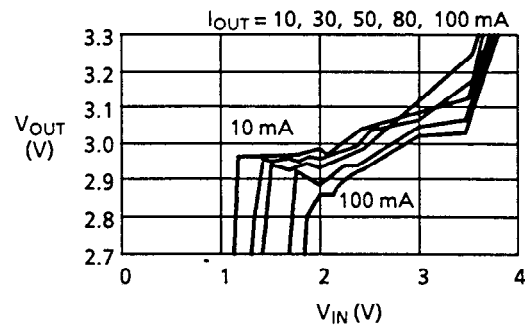

2.4 FL5H ( $L = 100 \mu H$ ), D1NS4,  $T_a = 25^\circ C$

(a)  $I_{OUT}$ - $V_{OUT}$

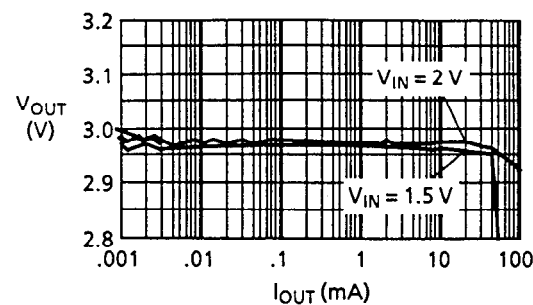

(b)  $V_{IN}$ - $V_{OUT}$

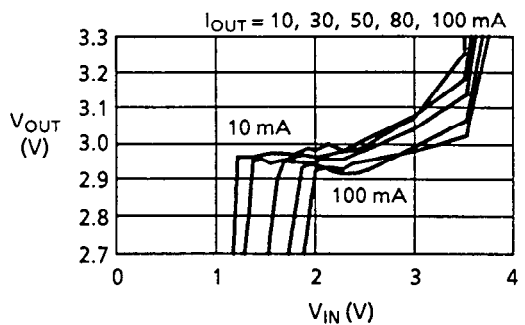

2.5 NLC453232 (L = 47  $\mu$ H), D1NS4, Ta = 25°C

(a) I<sub>OUT</sub>-V<sub>OUT</sub>

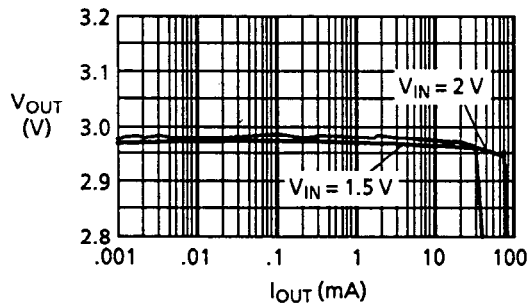

(b) V<sub>IN</sub>-V<sub>OUT</sub>

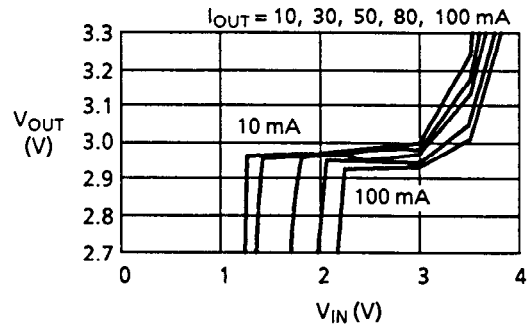

2.6 NL453232 (L = 100  $\mu$ H), D1NS4, Ta = 25°C

(a) I<sub>OUT</sub>-V<sub>OUT</sub>

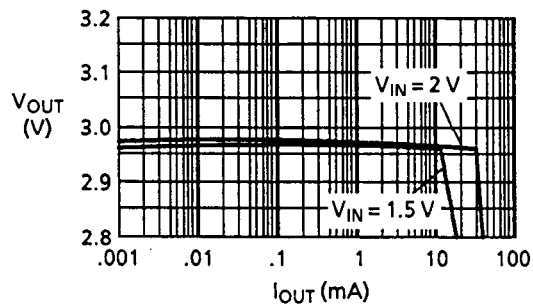

(b) V<sub>IN</sub>-V<sub>OUT</sub>

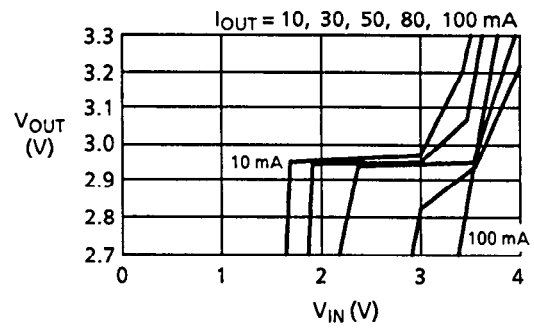

3. S-8435CF (C<sub>OUT</sub> = 47  $\mu$ F)

3.1 RCH654 (L = 39  $\mu$ H), D1NS4, Ta = 25°C

(a) I<sub>OUT</sub>-V<sub>OUT</sub>

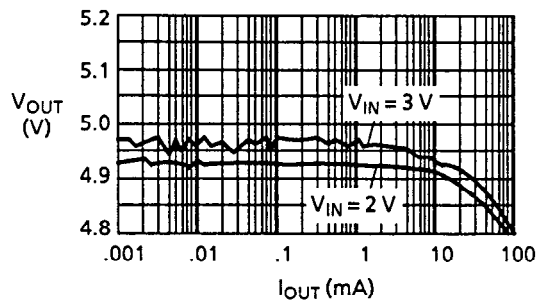

(b) V<sub>IN</sub>-V<sub>OUT</sub>

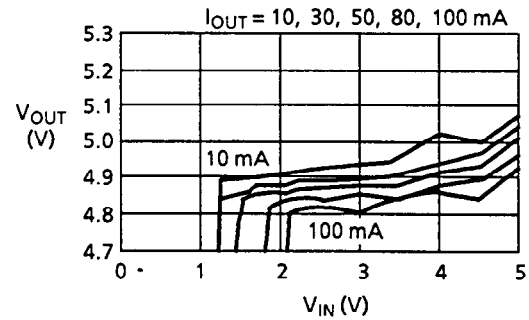

3.2 RCH654 (L = 100  $\mu$ H), D1NS4, Ta = 25°C

(a) I<sub>OUT</sub>-V<sub>OUT</sub>

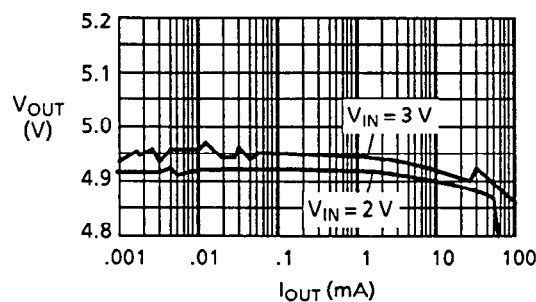

(b) V<sub>IN</sub>-V<sub>OUT</sub>

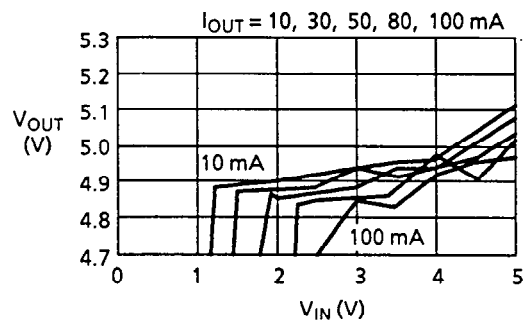

**STEP-UP SWITCHING REGULATORS**  
**S-8435/8436 Series**

3.3 RCH654 (L = 270  $\mu$ H), D1NS4, Ta = 25°C

(a) I<sub>OUT</sub>-V<sub>OUT</sub>

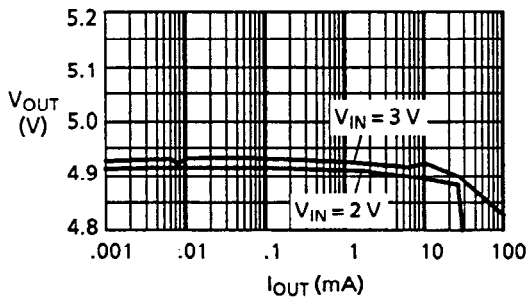

(b) V<sub>IN</sub>-V<sub>OUT</sub>

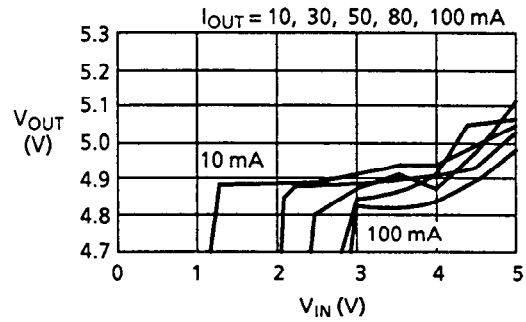

3.4 FL5H (L = 100  $\mu$ H), D1NS4, Ta = 25°C

(a) I<sub>OUT</sub>-V<sub>OUT</sub>

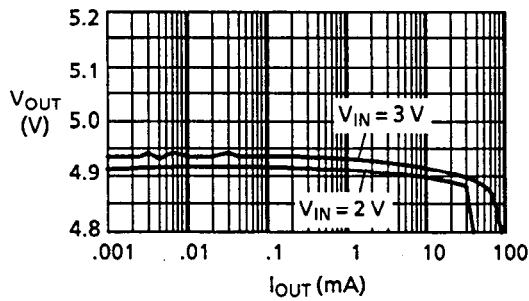

(b) V<sub>IN</sub>-V<sub>OUT</sub>

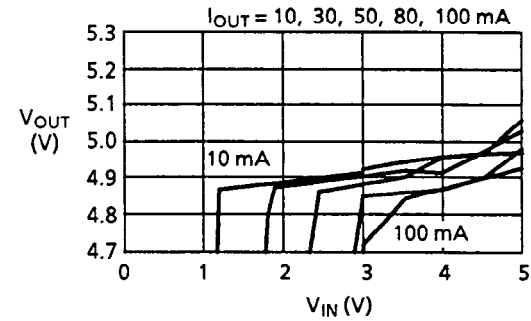

3.5 NLC453232 (L = 47  $\mu$ H), D1NS4, Ta = 25°C

(a) I<sub>OUT</sub>-V<sub>OUT</sub>

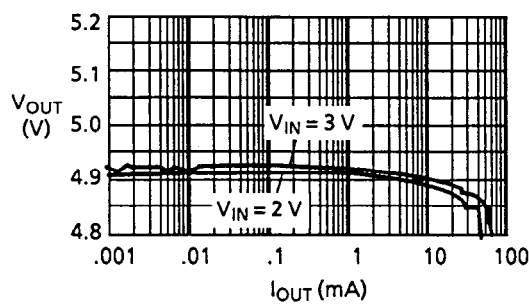

(b) V<sub>IN</sub>-V<sub>OUT</sub>

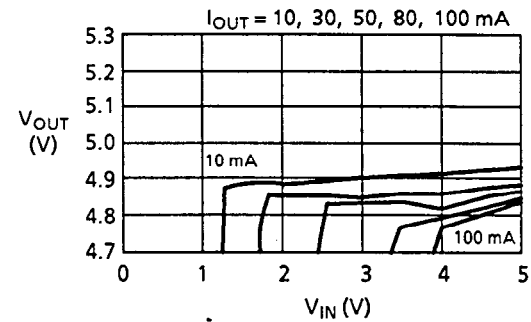

3.6 NL453232 (L = 100  $\mu$ H), D1NS4, Ta = 25°C

(a) I<sub>OUT</sub>-V<sub>OUT</sub>

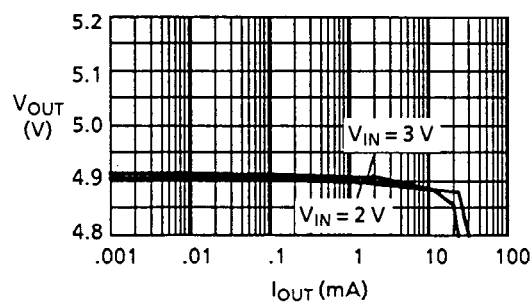

(b) V<sub>IN</sub>-V<sub>OUT</sub>

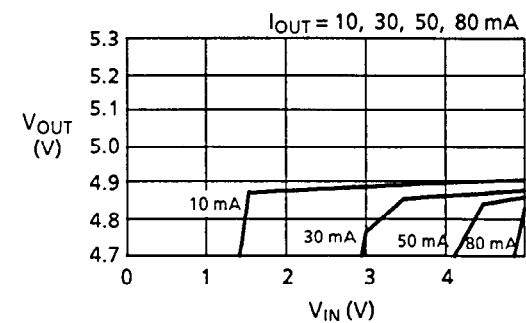

4. S-8435DF ( $C_{OUT} = 47 \mu F$ )

4.1 RCH654 ( $L = 39 \mu H$ ), D1NS4,  $T_a = 25^\circ C$

(a)  $I_{OUT}$ - $V_{OUT}$

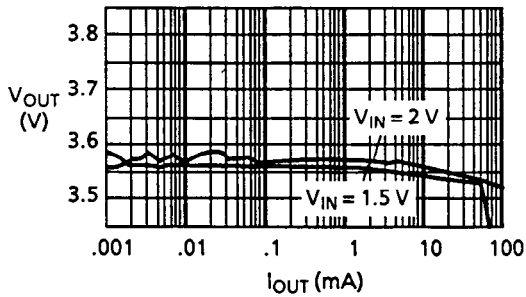

(b)  $V_{IN}$ - $V_{OUT}$

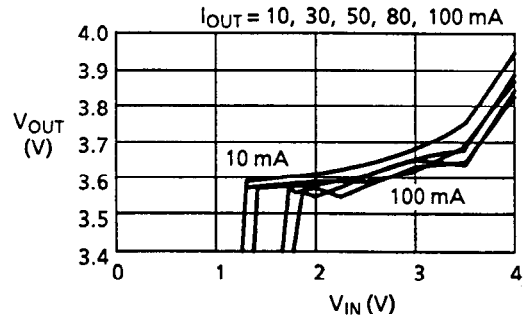

4.2 RCH654 ( $L = 100 \mu H$ ), D1NS4,  $T_a = 25^\circ C$

(a)  $I_{OUT}$ - $V_{OUT}$

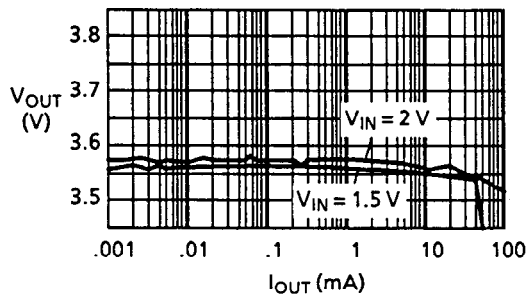

(b)  $V_{IN}$ - $V_{OUT}$

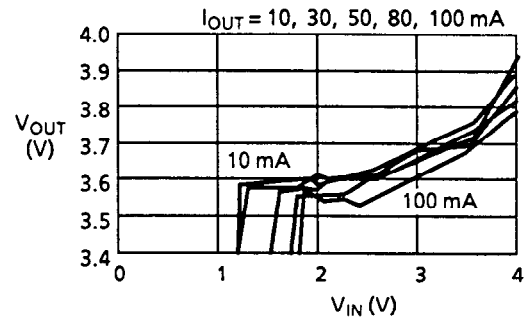

4.3 RCH654 ( $L = 270 \mu H$ ), D1NS4,  $T_a = 25^\circ C$

(a)  $I_{OUT}$ - $V_{OUT}$

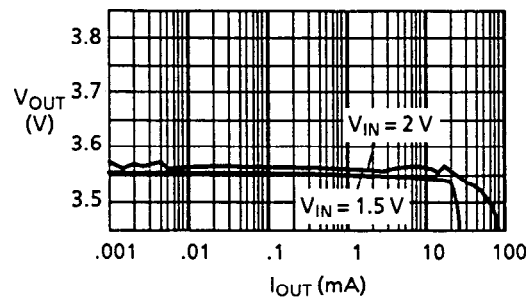

(b)  $V_{IN}$ - $V_{OUT}$

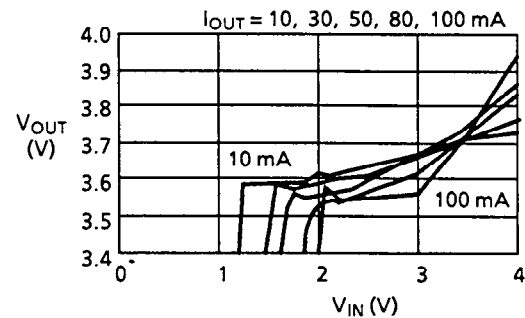

4.4 FL5H ( $L = 100 \mu H$ ), D1NS4,  $T_a = 25^\circ C$

(a)  $I_{OUT}$ - $V_{OUT}$

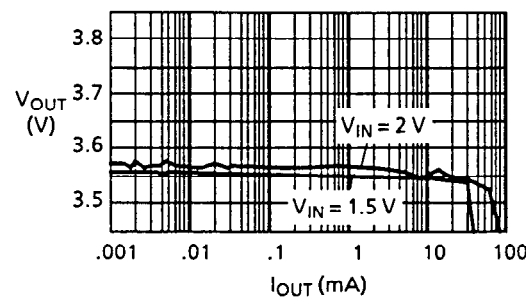

(b)  $V_{IN}$ - $V_{OUT}$

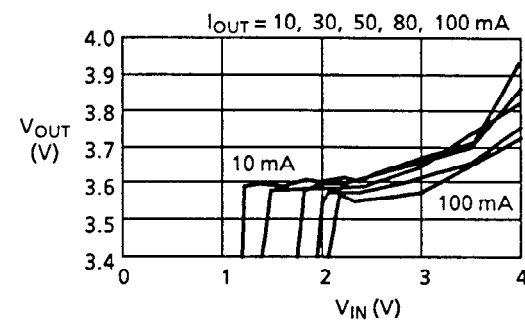



**STEP-UP SWITCHING REGULATORS**  
**S-8435/8436 Series**

4.5 NLC453232 (L = 47  $\mu$ H), D1NS4, Ta = 25°C

(a) I<sub>OUT</sub>-V<sub>OUT</sub>

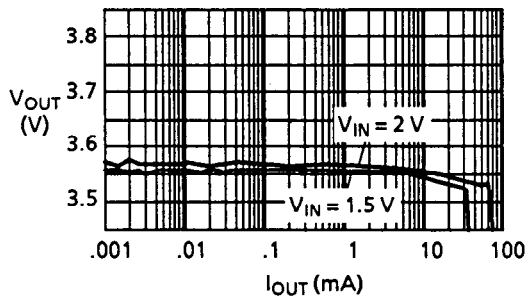

(b) V<sub>IN</sub>-V<sub>OUT</sub>

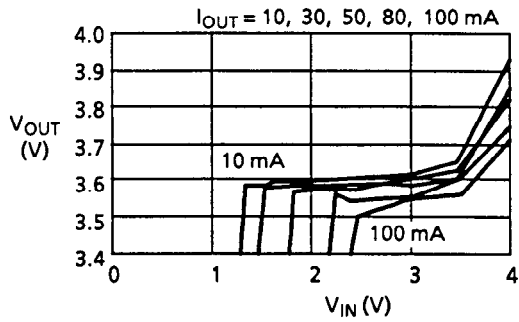

4.6 NL453232 (L = 100  $\mu$ H), D1NS4, Ta = 25°C

(a) I<sub>OUT</sub>-V<sub>OUT</sub>

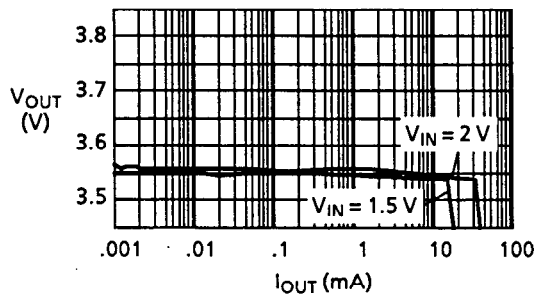

(b) V<sub>IN</sub>-V<sub>OUT</sub>

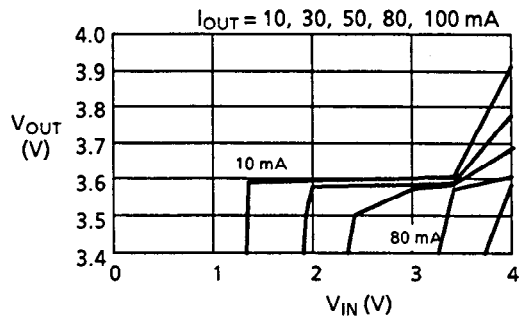

5. S-8435FF (C<sub>OUT</sub> = 22  $\mu$ F)

5.1 RCH654 (L = 470  $\mu$ H), D1NS4, Ta = 25°C

(a) I<sub>OUT</sub>-V<sub>OUT</sub>

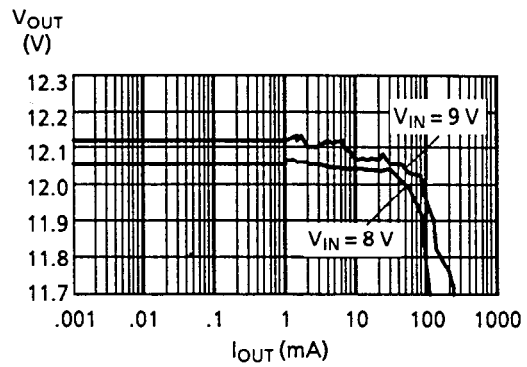
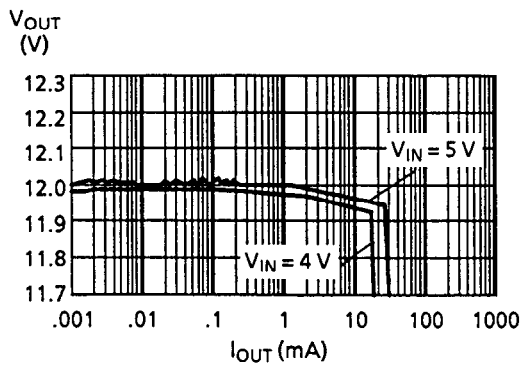

(b) V<sub>IN</sub>-V<sub>OUT</sub>

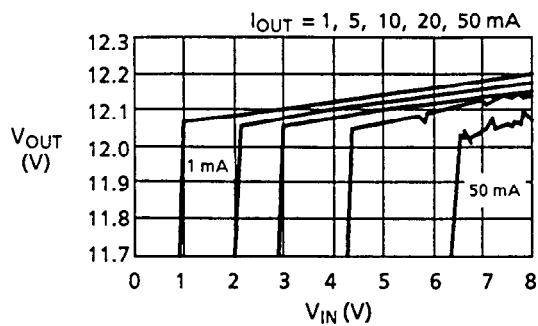

5.2 RCH654 (L = 270  $\mu$ H), D1NS4, Ta = 25°C

(a) I<sub>OUT</sub>-V<sub>OUT</sub>

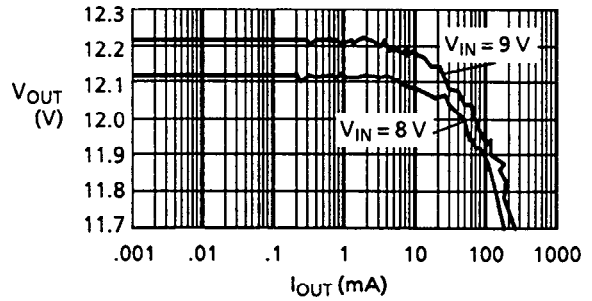
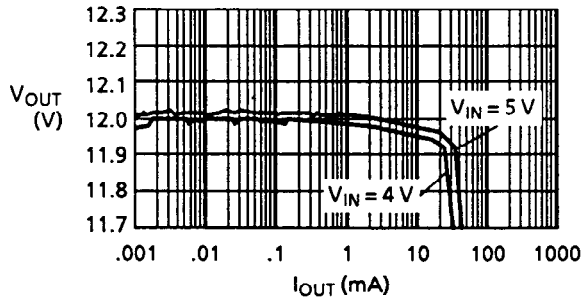

(b) V<sub>IN</sub>-V<sub>OUT</sub>

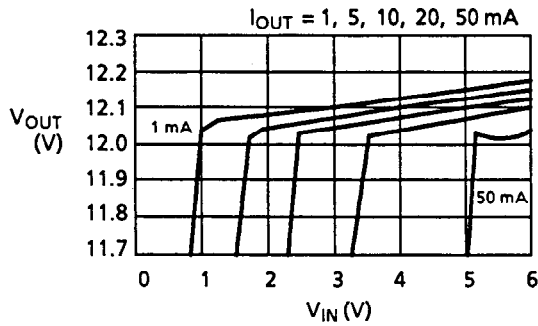

5.3 RCH855 (L = 100  $\mu$ H), D1NS4, Ta = 25°C

(a) I<sub>OUT</sub>-V<sub>OUT</sub>

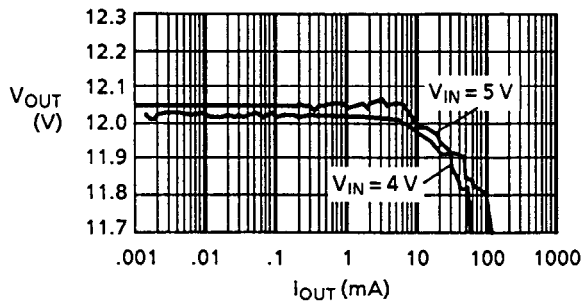

(b) V<sub>IN</sub>-V<sub>OUT</sub>

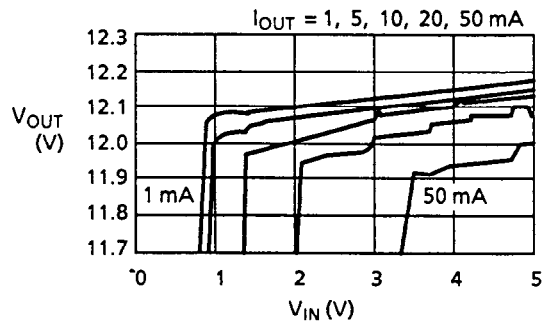

5.4 RCH855 (L = 47  $\mu$ H), D1NS4, Ta = 25°C

(a) I<sub>OUT</sub>-V<sub>OUT</sub>

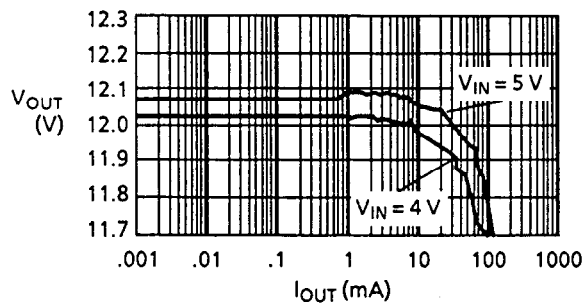

(b) V<sub>IN</sub>-V<sub>OUT</sub>

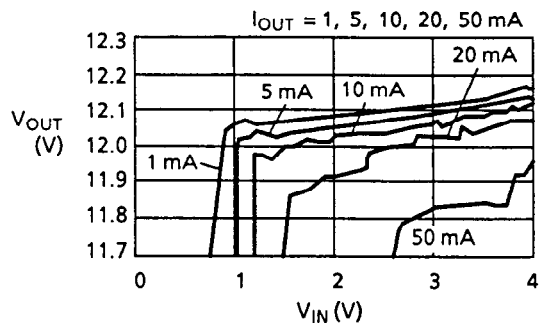

**STEP-UP SWITCHING REGULATORS**  
**S-8435/8436 Series**

[II] S-8436 Series

1. S-8436AF ( $C_{OUT} = 69 \mu F$ )

RCH654 ( $L = 100 \mu H$ ), D1NS4, 2SC3279,  $R_b = 300 \Omega$ ,  $T_a = 25^\circ C$

(a)  $I_{OUT}$ - $V_{OUT}$

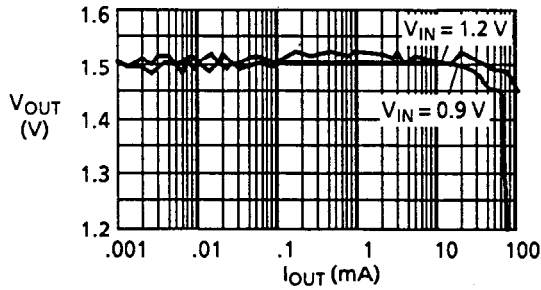

(b)  $V_{IN}$ - $V_{OUT}$

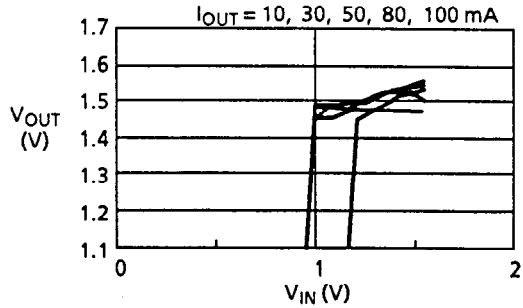

NOTE: Do not use the power MOS FET whose threshold voltage is 1.5 V or more.

2. S-8436BF ( $C_{OUT} = 69 \mu F$ )

2.1 CRCH654 ( $L = 47 \mu H$ ), D1NS4, 2SC3279,  $R_b = 300 \Omega$ ,  $T_a = 25^\circ C$

(a)  $I_{OUT}$ - $V_{OUT}$

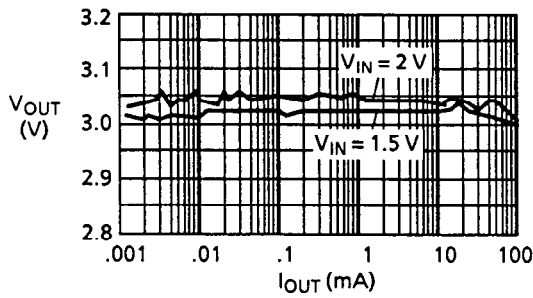

(b)  $V_{IN}$ - $V_{OUT}$

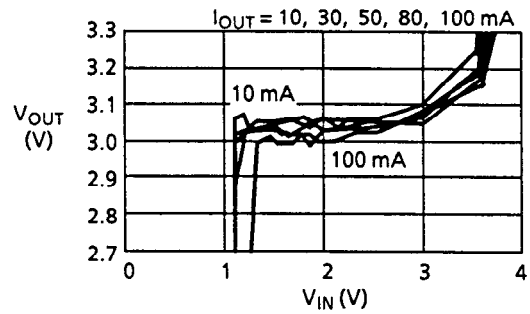

2.2. RCH654 ( $L = 100 \mu H$ ), D1NS4, 2SC3279,  $R_b = 300 \Omega$ ,  $T_a = 25^\circ C$

(a)  $I_{OUT}$ - $V_{OUT}$

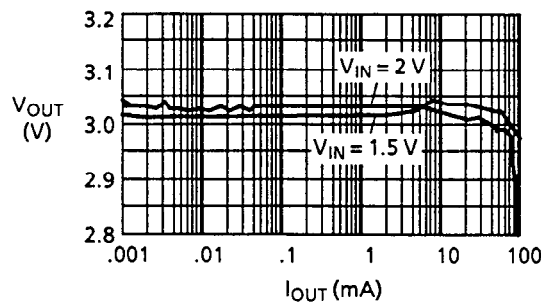

(b)  $V_{IN}$ - $V_{OUT}$

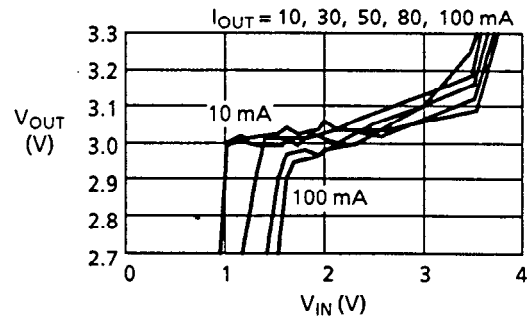

2.3 RCH654 ( $L = 270 \mu H$ ), D1NS4, 2SC3279,  $R_b = 300 \Omega$ ,  $T_a = 25^\circ C$

(a)  $I_{OUT}$ - $V_{OUT}$

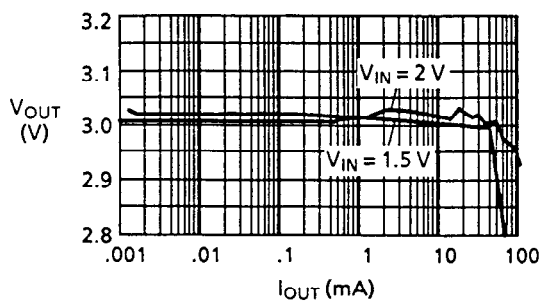

(b)  $V_{IN}$ - $V_{OUT}$

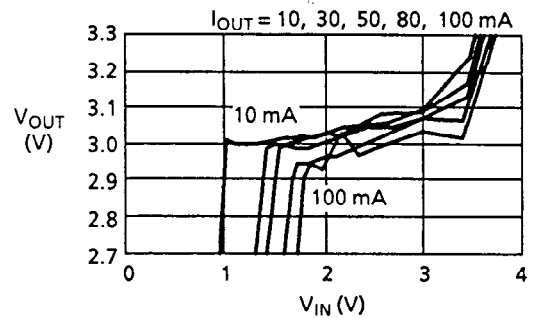

2.4 RCH654 (L = 47  $\mu$ H), D1NS4, 2SK1112\*, Ta = 25°C

(a)  $I_{OUT}$ - $V_{OUT}$

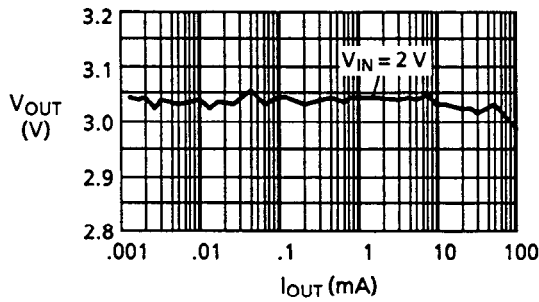

(b)  $V_{IN}$ - $V_{OUT}$

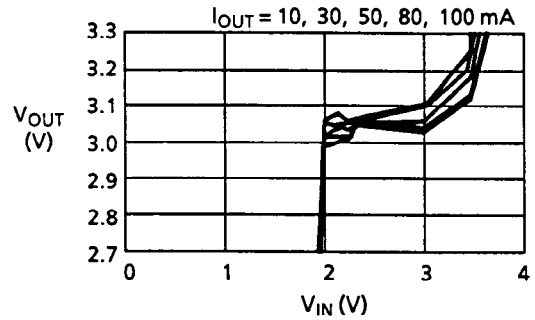

2.5 RCH654 (L = 100  $\mu$ H), D1NS4, 2SK1112\*, Ta = 25°C

(a)  $I_{OUT}$ - $V_{OUT}$

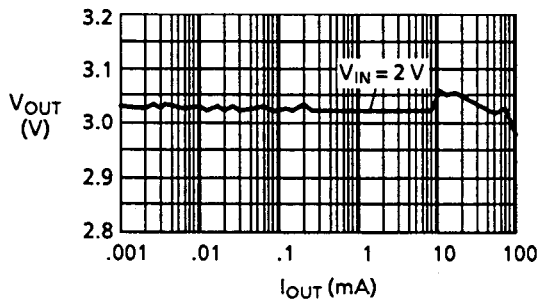

(b)  $V_{IN}$ - $V_{OUT}$

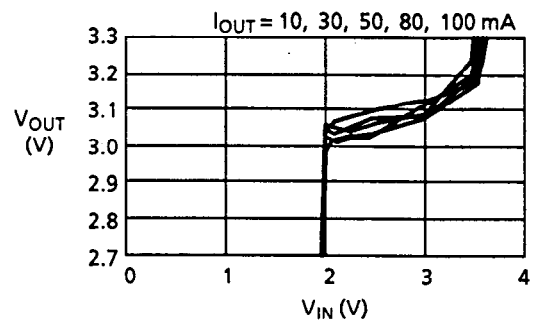

2.6 RCH654 (L = 270  $\mu$ H), D1NS4, 2SK1112\*, Ta = 25°C

(a)  $I_{OUT}$ - $V_{OUT}$

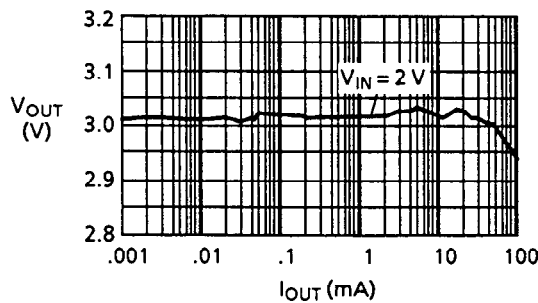

(b)  $V_{IN}$ - $V_{OUT}$

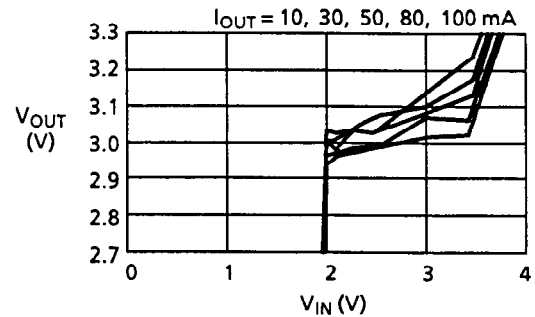

\* Apply 2 V or more of supply voltage to switch the MOS FET, because the threshold voltage is 2 V in 2SK1112.

3. S-8436CF (C<sub>OUT</sub> = 69  $\mu$ F)

3.1 RCH654 (L = 47  $\mu$ H), D1NS4, 2SC3279, R<sub>b</sub> = 300  $\Omega$ , Ta = 25°C

(a)  $I_{OUT}$ - $V_{OUT}$

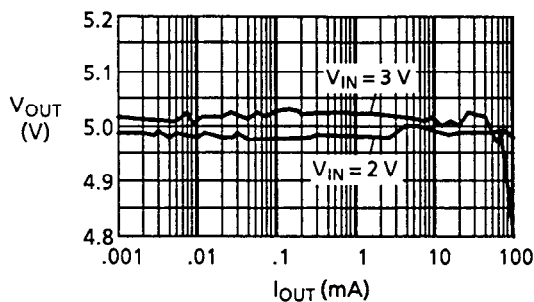

(b)  $V_{IN}$ - $V_{OUT}$

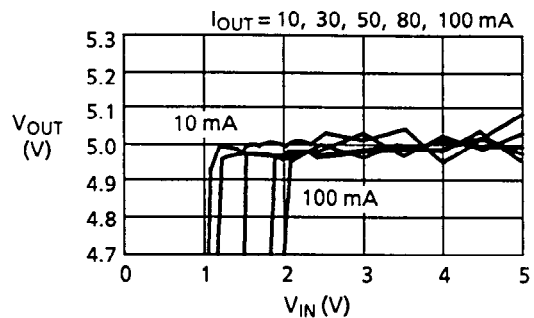

**STEP-UP SWITCHING REGULATORS**  
**S-8435/8436 Series**

3.2 RCH654 (L = 100  $\mu$ H), D1NS4, 2SC3279, R<sub>b</sub> = 300  $\Omega$ , T<sub>a</sub> = 25°C

(a) I<sub>OUT</sub>-V<sub>OUT</sub>

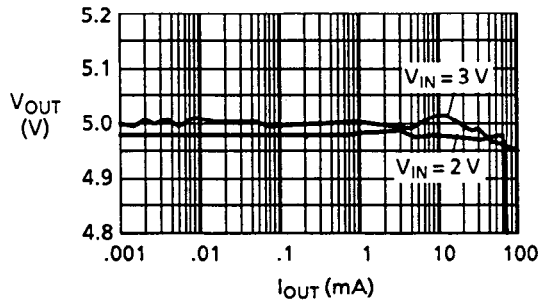

(b) V<sub>IN</sub>-V<sub>OUT</sub>

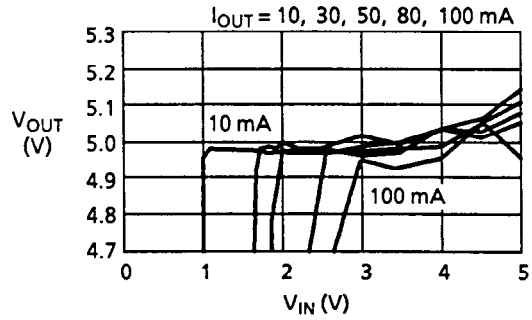

3.3 RCH654 (L = 270  $\mu$ H), D1NS4, 2SC3279, R<sub>b</sub> = 300  $\Omega$ , T<sub>a</sub> = 25°C

(a) I<sub>OUT</sub>-V<sub>OUT</sub>

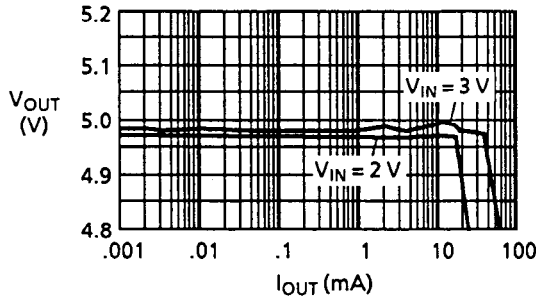

(b) V<sub>IN</sub>-V<sub>OUT</sub>

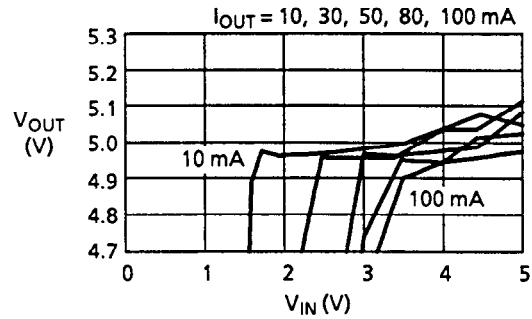

3.4 RCH654 (L = 47  $\mu$ H), D1NS4, 2SK1112\*, T<sub>a</sub> = 25°C

(a) I<sub>OUT</sub>-V<sub>OUT</sub>

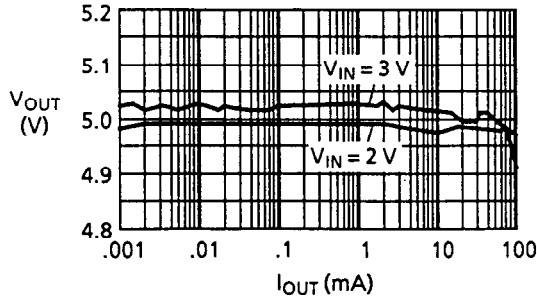

(b) V<sub>IN</sub>-V<sub>OUT</sub>

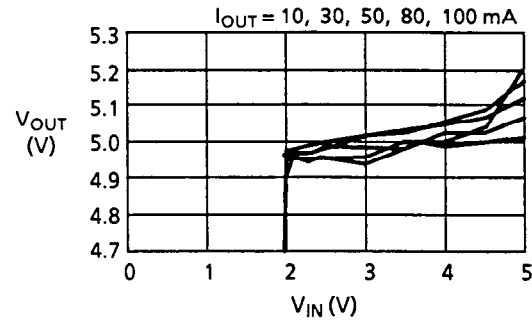

3.5 RCH654 (L = 100  $\mu$ H), D1NS4, 2SK1112\*, T<sub>a</sub> = 25°C

(a) I<sub>OUT</sub>-V<sub>OUT</sub>

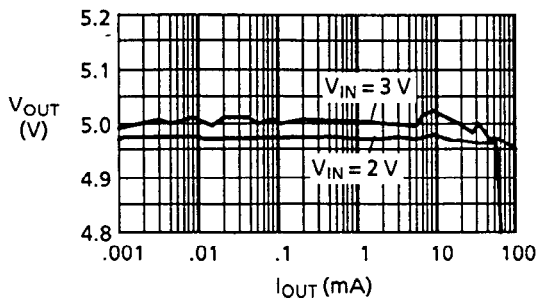

(b) V<sub>IN</sub>-V<sub>OUT</sub>

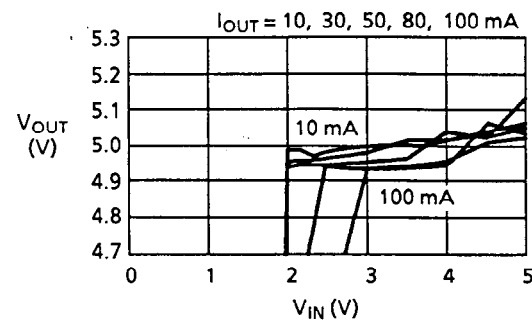

\* Apply 2 V or more of supply voltage to switch the MOS FET, because the threshold voltage is 2 V in 2SK1112.

3.6 RCH654 (L = 270  $\mu$ H), D1NS4, 2SK1112\*, Ta = 25°C

(a) I<sub>OUT</sub>-V<sub>OUT</sub>

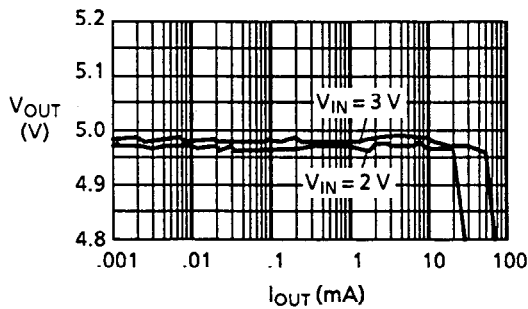

(b) V<sub>IN</sub>-V<sub>OUT</sub>

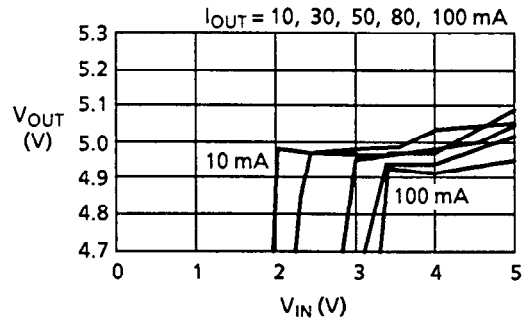

\* Apply 2 V or more of supply voltage to switch the MOS FET, because the threshold voltage is 2 V in 2SK1112.

4. S-8436DF (C<sub>OUT</sub> = 69  $\mu$ F)

4.1 RCH654 (L = 47  $\mu$ H), D1NS4, 2SC3279, R<sub>b</sub> = 300  $\Omega$ , Ta = 25°C

(a) I<sub>OUT</sub>-V<sub>OUT</sub>

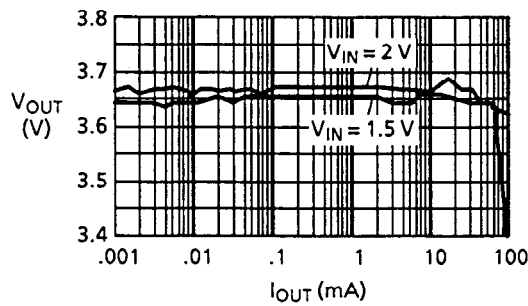

(b) V<sub>IN</sub>-V<sub>OUT</sub>

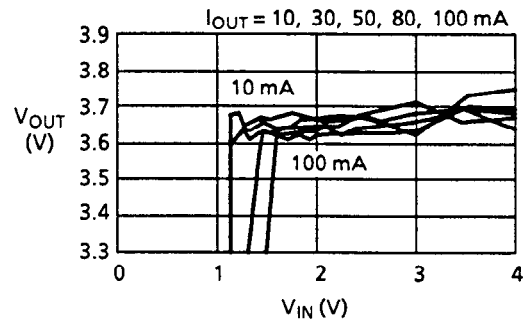

4.2 RCH654 (L = 100  $\mu$ H), D1NS4, 2SC3279, R<sub>b</sub> = 300  $\Omega$ , Ta = 25°C

(a) I<sub>OUT</sub>-V<sub>OUT</sub>

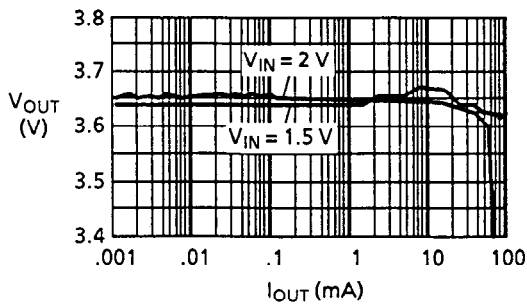

(b) V<sub>IN</sub>-V<sub>OUT</sub>

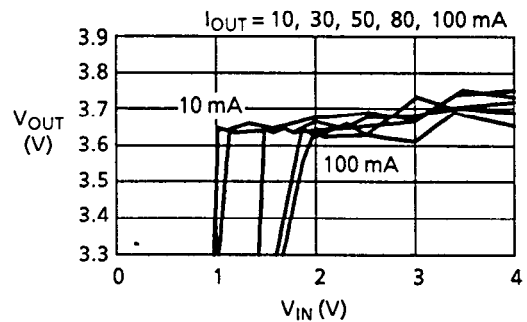

4.3 RCH654 (L = 270  $\mu$ H), D1NS4, 2SC3279, R<sub>b</sub> = 300  $\Omega$ , Ta = 25°C

(a) I<sub>OUT</sub>-V<sub>OUT</sub>

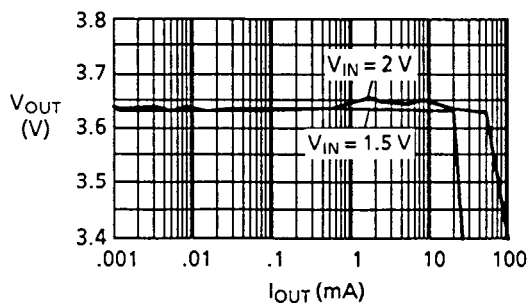

(b) V<sub>IN</sub>-V<sub>OUT</sub>

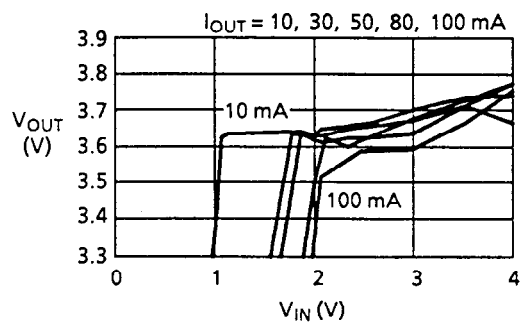

**STEP-UP SWITCHING REGULATORS**  
**S-8435/8436 Series**

4.4 RCH654 (L = 47  $\mu$ H), D1NS4, 2SK1112\*, Ta = 25°C

(a) I<sub>OUT</sub>-V<sub>OUT</sub>

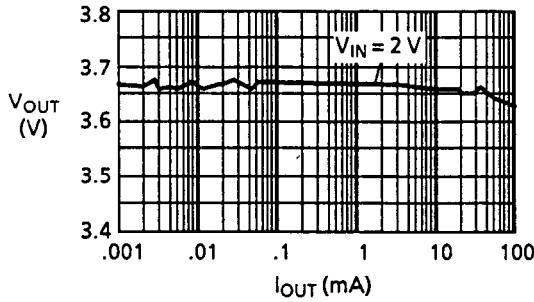

(b) VIN-V<sub>OUT</sub>

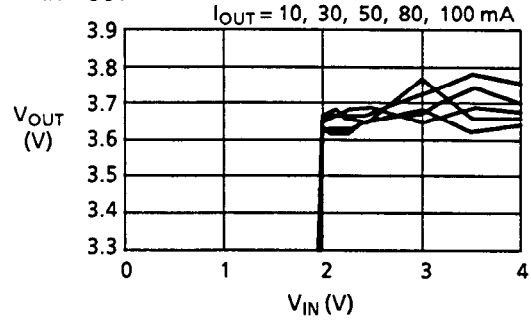

4.5 RCH654 (L = 100  $\mu$ H), D1NS4, 2SK1112\*, Ta = 25°C

(a) I<sub>OUT</sub>-V<sub>OUT</sub>

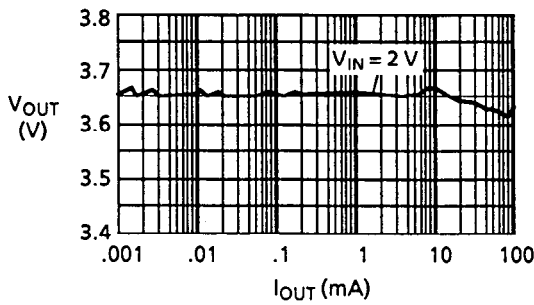

(b) VIN-V<sub>OUT</sub>

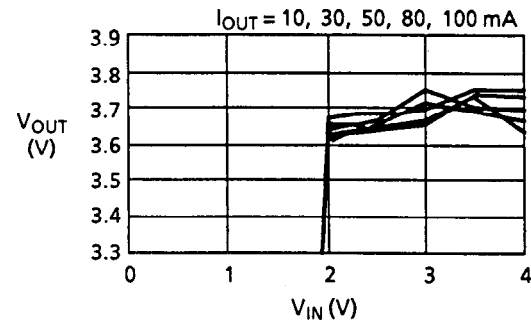

4.6 RCH654 (L = 270  $\mu$ H), D1NS4, 2SK1112\*, Ta = 25°C

(a) I<sub>OUT</sub>-V<sub>OUT</sub>

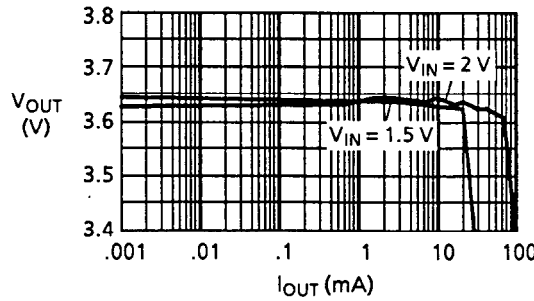

(b) VIN-V<sub>OUT</sub>

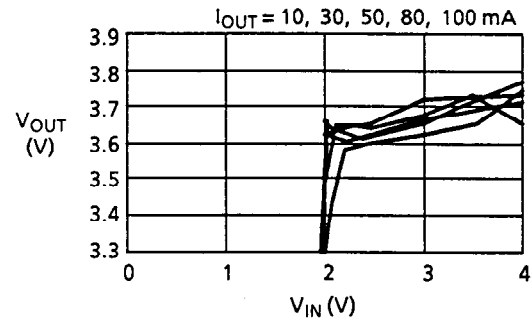

\* Apply 2 V or more of supply voltage to switch the MOS FET, because the threshold voltage is 2 V in 2SK1112.

5. S-8436FF (C<sub>OUT</sub> = 22  $\mu$ F)

5.1 RCH654 (L = 470  $\mu$ H), D1NS4, 2SC3279, R<sub>b</sub> = 5 k $\Omega$ , Ta = 25°C

(a) I<sub>OUT</sub>-V<sub>OUT</sub>

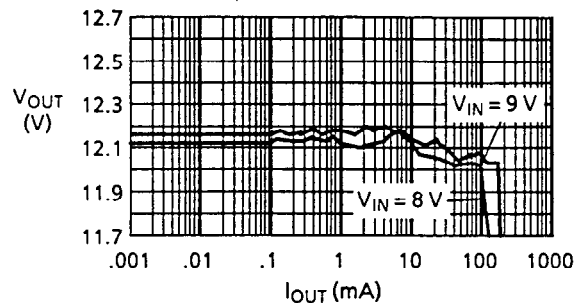
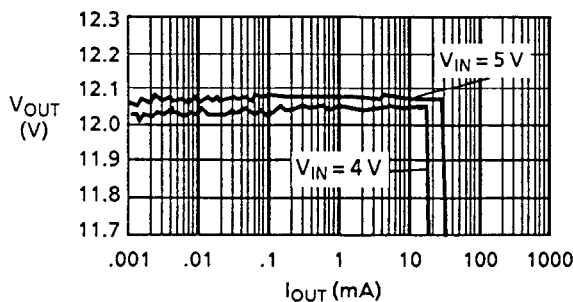

(b)  $V_{IN}$ - $V_{OUT}$

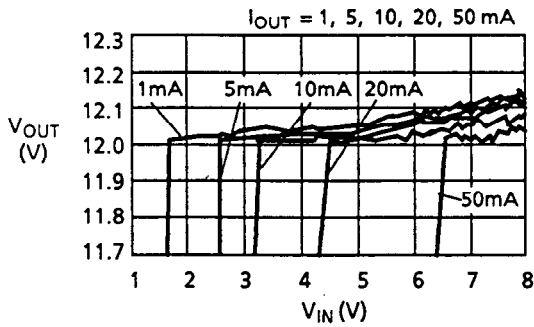

5.2 RCH654 ( $L = 270 \mu\text{H}$ ), D1NS4, 2SC3279,  $R_b = 5 \text{ k}\Omega$ ,  $T_a = 25^\circ\text{C}$

(a)  $I_{OUT}$ - $V_{OUT}$

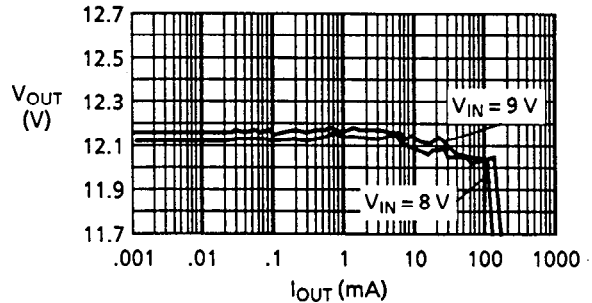
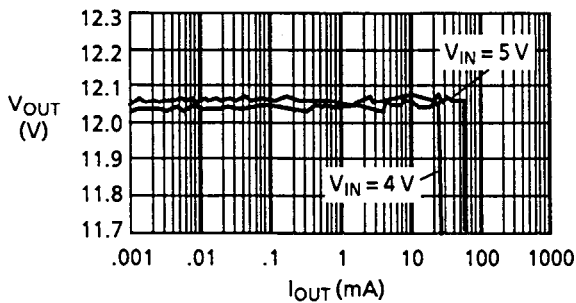

(b)  $V_{IN}$ - $V_{OUT}$

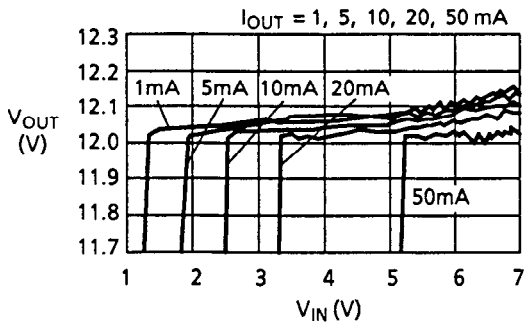

5.3 RCH855 ( $L = 100 \mu\text{H}$ ), D1NS4, 2SC3279,  $R_b = 2 \text{ k}\Omega$ ,  $T_a = 25^\circ\text{C}$

(a)  $I_{OUT}$ - $V_{OUT}$

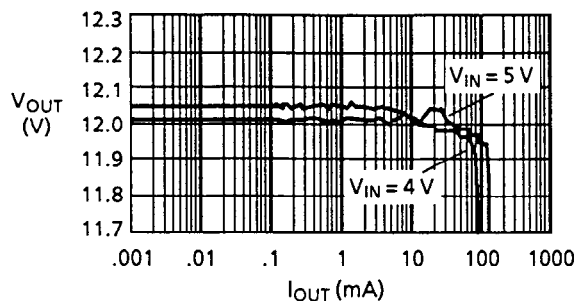

(b)  $V_{IN}$ - $V_{OUT}$

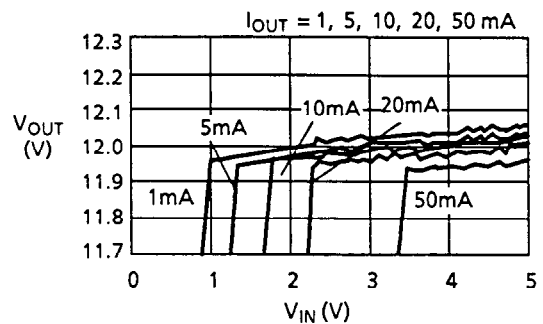



**STEP-UP SWITCHING REGULATORS**  
**S-8435/8436 Series**

5.4 RCH855 (L = 47  $\mu$ H), D1NS4, 2SC3279, R<sub>b</sub> = 750  $\Omega$ , T<sub>a</sub> = 25°C

(a) I<sub>OUT</sub>-V<sub>OUT</sub>

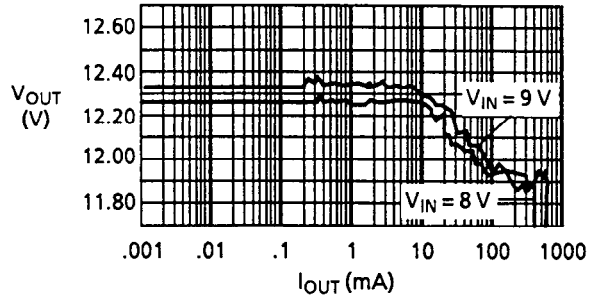
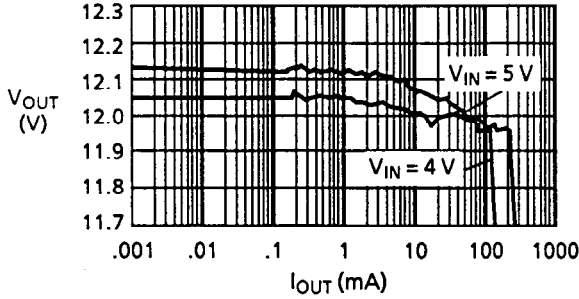

(b) V<sub>IN</sub>-V<sub>OUT</sub>

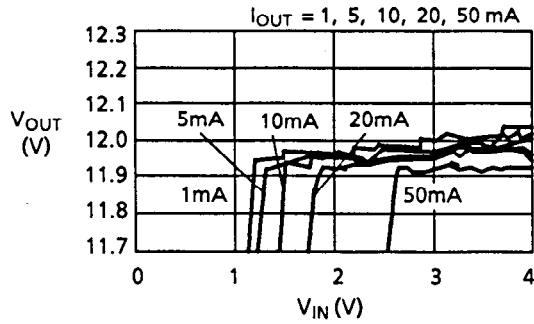

5.5 RCH654 (L = 470  $\mu$ H), D1NS4, 2SK1112\*, T<sub>a</sub> = 25°C

(a) I<sub>OUT</sub>-V<sub>OUT</sub>

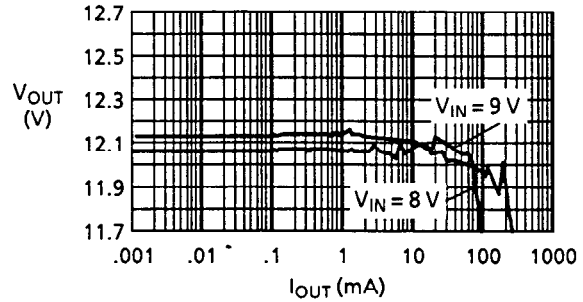
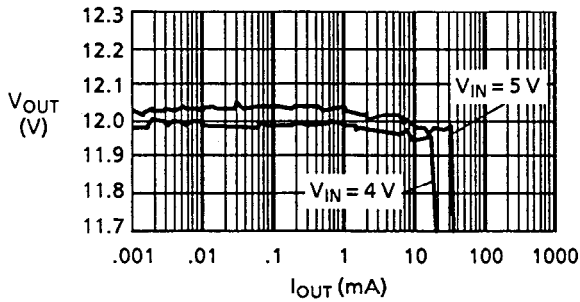

(b) V<sub>IN</sub>-V<sub>OUT</sub>

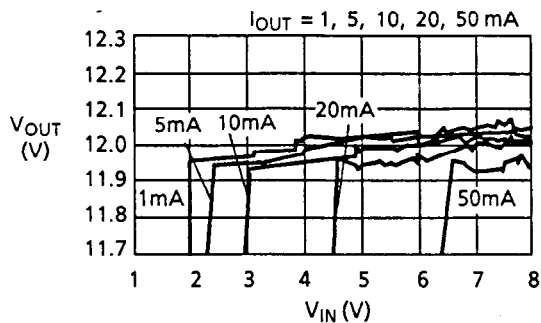

\* Apply 2 V or more of supply voltage to switch the MOS FET, because the threshold voltage is 2 V in 2SK1112.

5.6 RCH654 (L = 270  $\mu$ H), D1NS4, 2SK1112\*, Ta = 25°C

(a)  $I_{OUT}$ - $V_{OUT}$

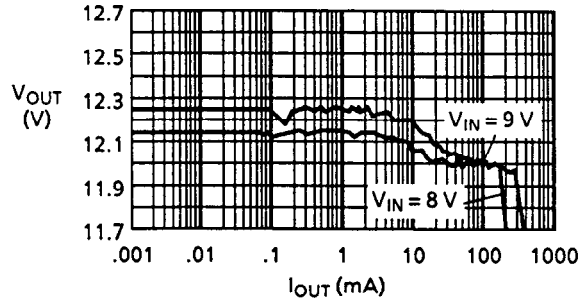
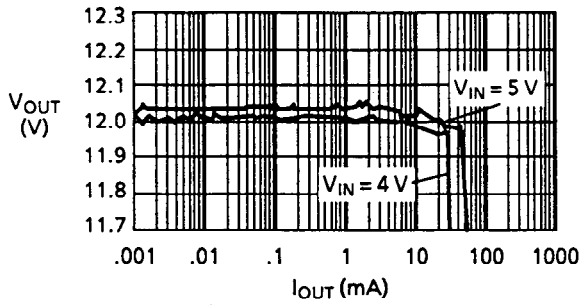

(b)  $V_{IN}$ - $V_{OUT}$

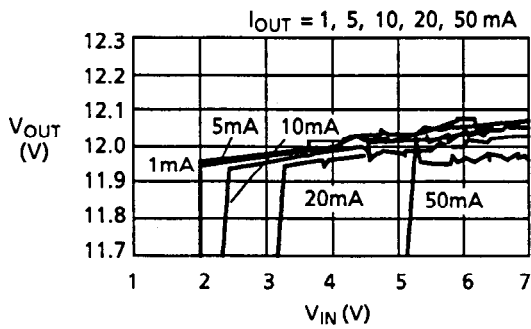

5.7 RCH654 (L = 100  $\mu$ H), D1NS4, 2SK1112\*, Ta = 25°C

(a)  $I_{OUT}$ - $V_{OUT}$

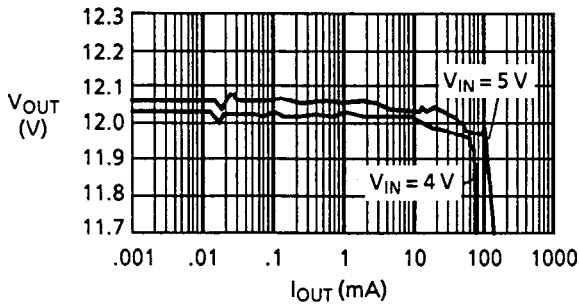

(b)  $V_{IN}$ - $V_{OUT}$

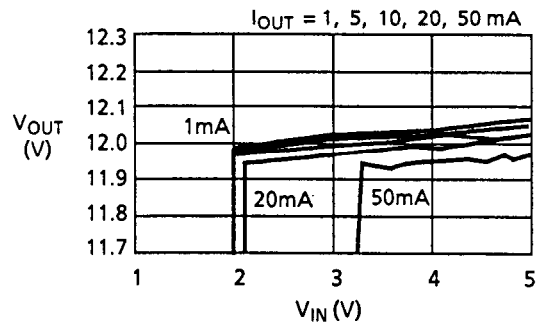

5.8 RCH855 (L = 47  $\mu$ H), D1NS4, 2SK1112\*, Ta = 25°C

(a)  $I_{OUT}$ - $V_{OUT}$

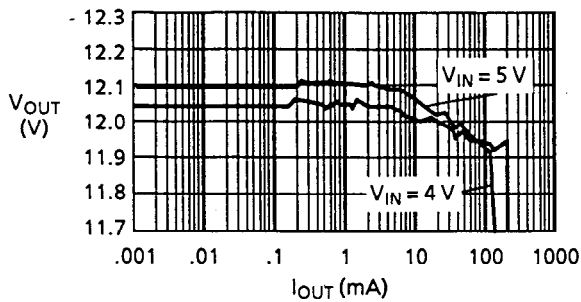

(b)  $V_{IN}$ - $V_{OUT}$

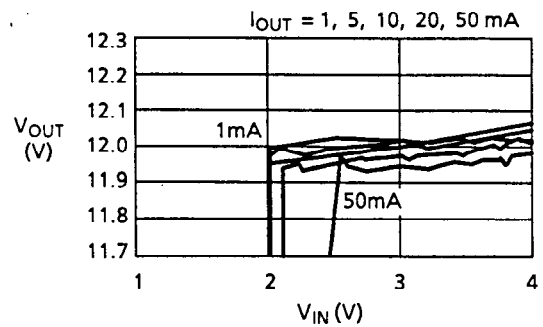

\* Apply 2 V or more of supply voltage to switch the MOS FET, because the threshold voltage is 2 V in 2SK1112.