

NF3000C-VZF Series (RoHS Compliant)

3-phase 3-line 500VAC

Wide band & High attenuation



UL1283 (file No.E102708)
EN60939-2 (file No.R50031313)

Applications

Transmitter, Inverter. UPS, CVCF, VVVF

Specifications

Part No.	Rated Current	Weight	Dimensions [mm]																		
			A	B	C	D	E	F	G	H	J	K	L	M	N	P	Q	R	S	T	
NF3010C-VZF	10A	0.5Kg	128	118	108	63	43	42	1	4.5x6	dia.4.5	M4	M4	21	88	21	19	35	10	2	fig1
NF3020C-VZF	20A	0.5Kg	128	118	108	63	43	42	1	4.5x6	dia.4.5	M4	M4	21	88	21	19	35	10	2	
NF3030C-VZF	30A	0.7Kg	145	135	125	70	50	42	1	4.5x6	dia.4.5	M4	M4	25	103	22	20	35	10	2	
NF3040C-VZF	40A	1.3Kg	179	167	155	90	70	54	1.6	4.5x6	dia.4.5	M5	M4	32	131	25	23	45	14	3	
NF3050C-VZF	50A	1.3Kg	179	167	155	90	70	54	1.6	4.5x6	dia.4.5	M5	M4	32	131	25	23	45	14	3	
NF3060C-VZF	60A	1.5Kg	179	167	155	90	70	54	1.6	4.5x6	dia.4.5	M5	M4	32	131	25	23	45	14	3	
NF3080C-VZF	80A	3.0Kg	260	245	230	189	144.5	120	90	80	61	12	6.5	M8	M5	-	-	-	-	-	fig2
NF3100C-VZF	100A	3.0Kg	260	245	230	189	144.5	120	90	80	61	12	6.5	M8	M5	-	-	-	-	-	
NF3150C-VZF	150A	5.5Kg	285	270	255	216	171	170	100	105	89	67	6.5	M8	M8	-	-	-	-	-	fig3
NF3200C-VZF	200A	10Kg																			
NF3250C-VZF	250A	11Kg																			fig4
NF3300C-VZF	300A	12Kg																			
NF3400C-VZF	400A	18Kg																			fig5
Rated Voltage	10-150A:500VAC,200-400A:480VAC																				
Leakage Current	10-150A: 3.0mA/200-400: 10mA																				
Ambient temp.	-20 up to 50 Deg.C (TUV : -20 up to 60 Deg.C)																				

fig.1 (10-60A)

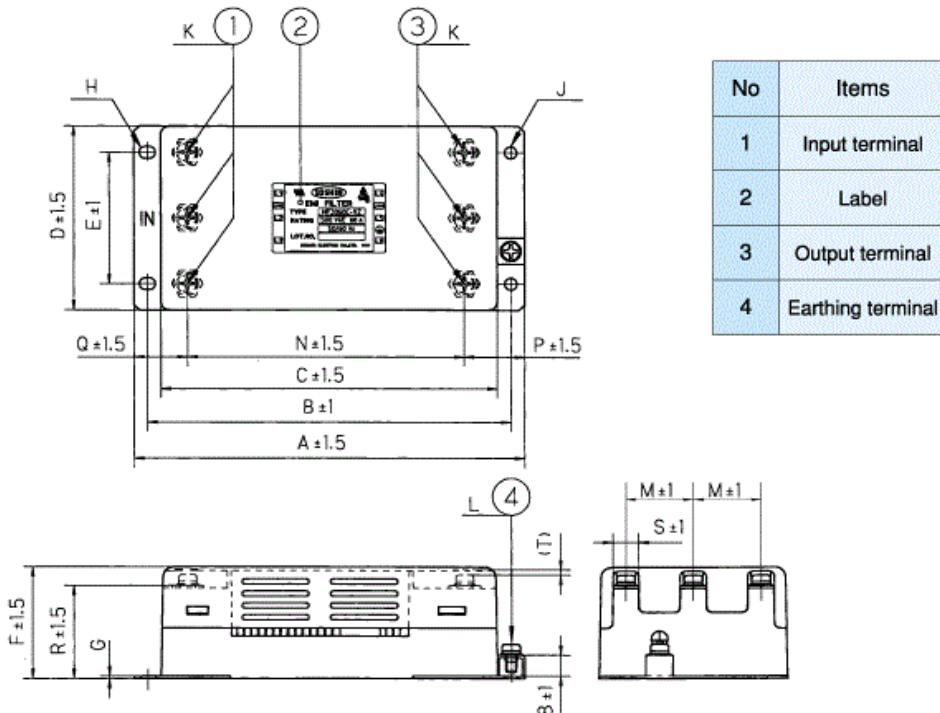
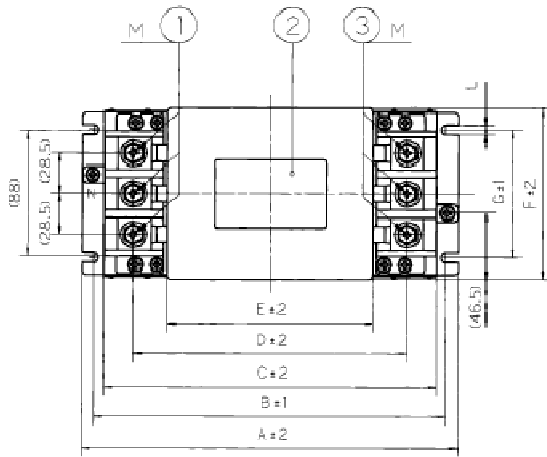

fig.2 (80, 100A)



No	Items
1	Input terminal
2	Label
3	Output terminal
4	Earthing terminal

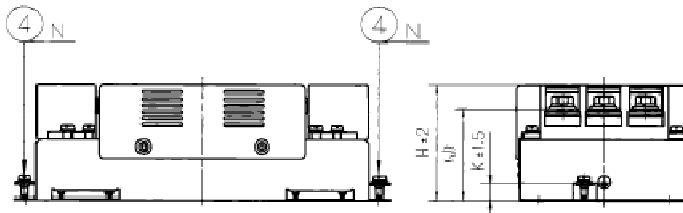
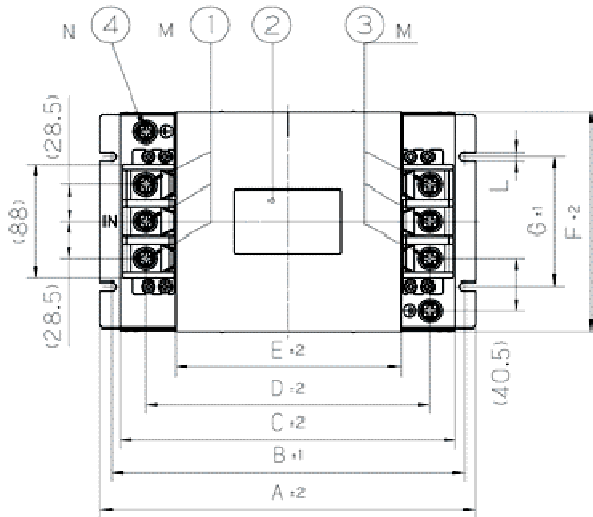

fig.3 (150A)



No	Items
1	Input terminal
2	Label
3	Output terminal
4	Earthing terminal

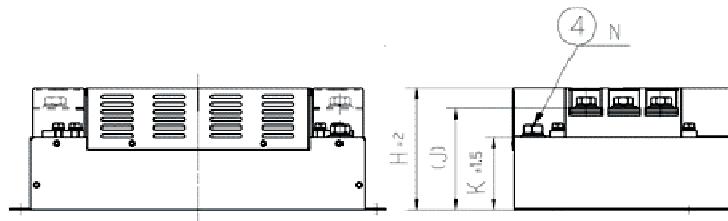
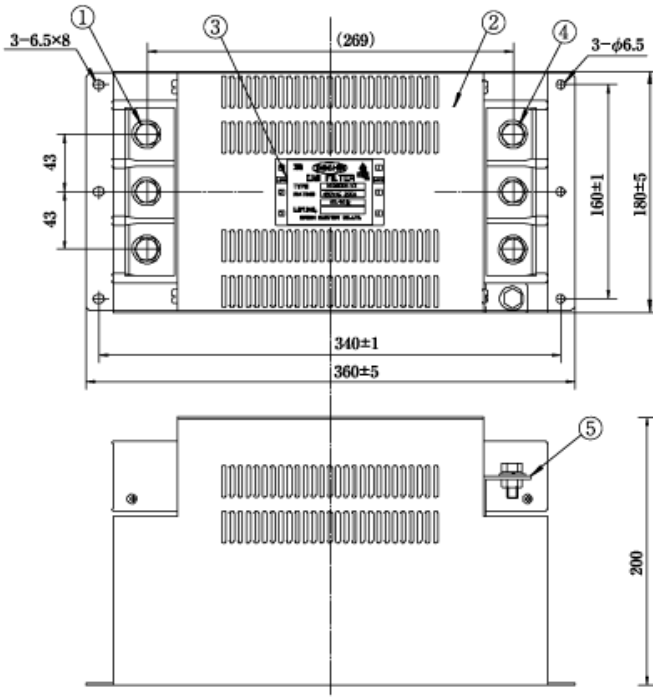
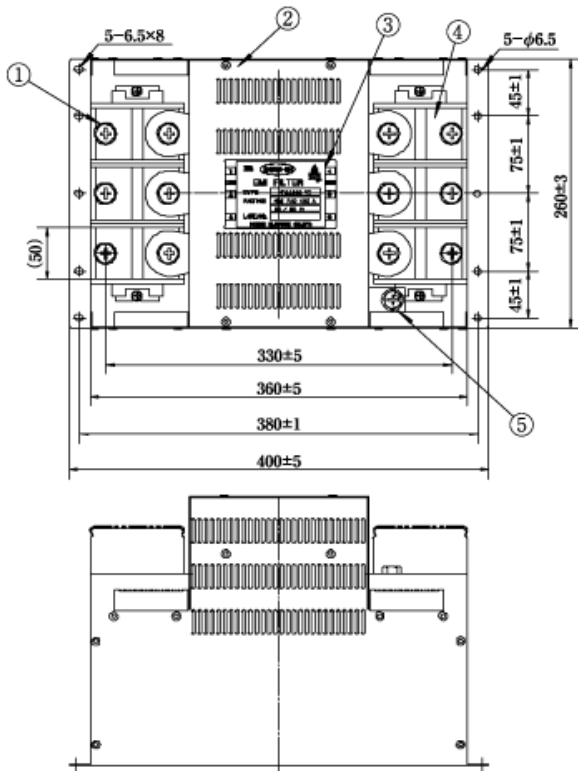

fig.4 (200, 250, 300A)



No	Item	Notes
①	Input terminal	M10
②	Metal case	
③	Label	
④	Output terminal	M10
⑤	Earthing terminal	M8

fig.5 (400A)



No	Item	Notes
①	Input terminal	M12
②	Metal case	
③	Label	
④	Output terminal	M12
⑤	Earthing terminal	M10

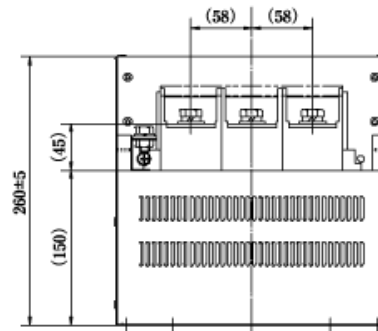

Characteristics (Typical) (50A)

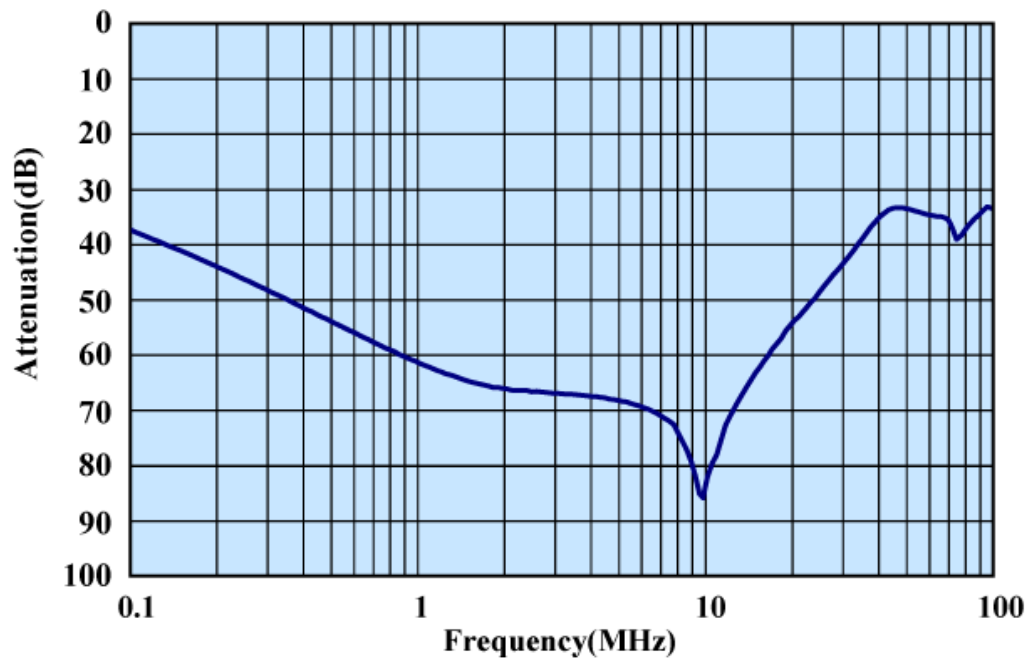

Characteristics (Typical) (100A)

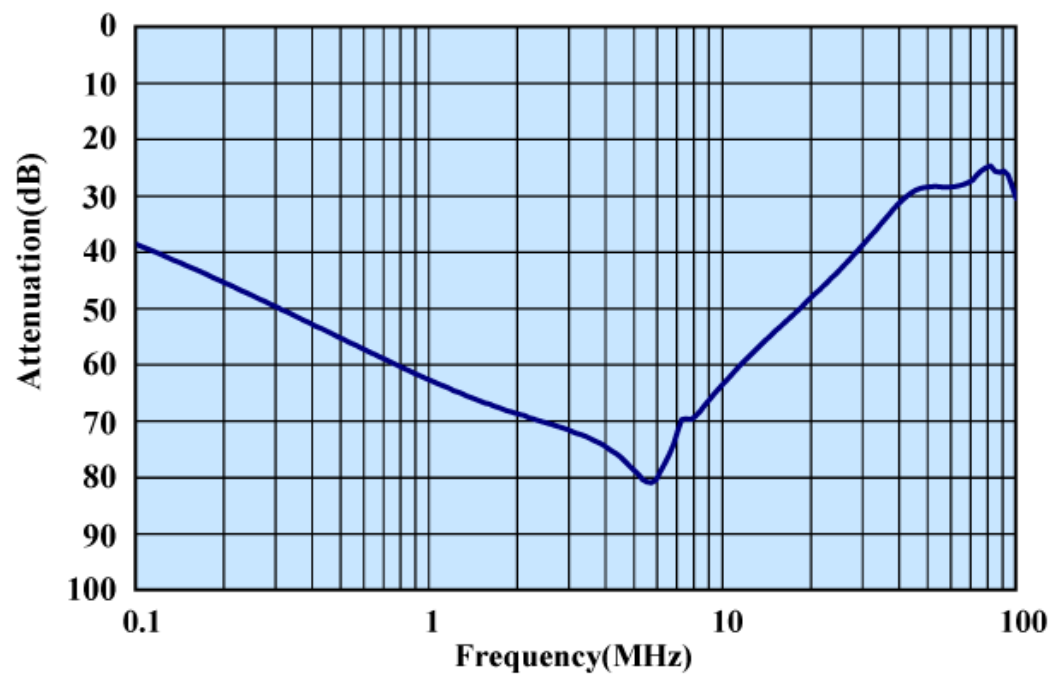

Circuit Diagram

