

1. PART NO. EXPRESSION :

L 2 - 4 7 N K - 1 0
 (a) (b) (c) (d)

- (a) Series code
- (b) Inductance code : 47N = 0.047uH
- (c) Tolerance code : K = ±10%, M = ±20%
- (d) 10 : Lead Free

2. CONFIGURATION & DIMENSIONS :

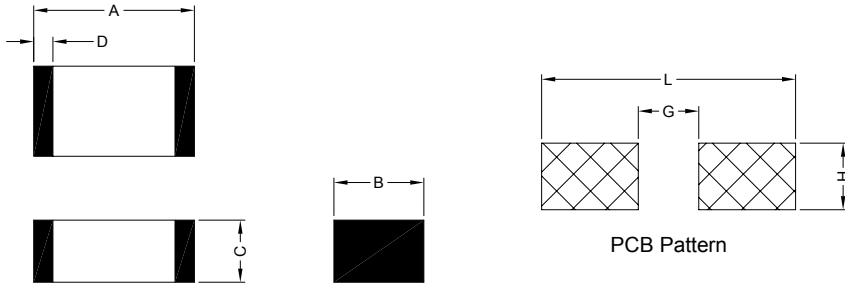

Unit:m/m

A	B	C	D	G	H	L
1.60±0.15	0.80±0.15	0.80±0.15	0.30±0.20	0.60 Ref.	0.80 Ref.	2.60 Ref.

3. SCHEMATIC :

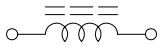

4. MATERIALS :

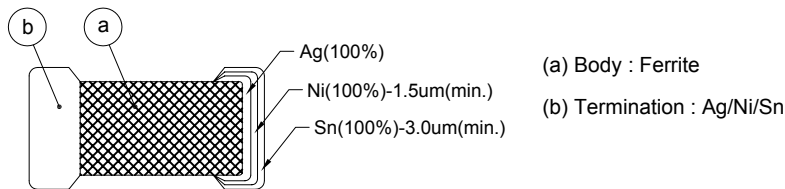

5. GENERAL SPECIFICATION :

- a) Temp. rise : 30°C Max.
- b) Rated current : Base on temp. rise
- c) Storage temp. : -40°C to +85°C
- d) Operating temp. : -40°C to +85°C
- e) Resistance to solder heat : 260°C.10secs



RoHS Compliant

NOTE : Specifications subject to change without notice. Please check our website for latest information.

01.04.2008



SUPERWORLD ELECTRONICS (S) PTE LTD

6. ELECTRICAL CHARACTERISTICS :

Part Number	EIA Size	Inductance (μ H)	Q Min.	Test Frequency (MHz)	SRF (MHz) Min.	DC Resistance (Ω) Max.	Rated Current (mA)
L2-47N□-10	0603	0.047	10	50	260	0.30	50
L2-68N□-10	0603	0.068	10	50	250	0.30	50
L2-82N□-10	0603	0.082	10	50	245	0.30	50
L2-R10□-10	0603	0.100	15	25	240	0.50	50
L2-R12□-10	0603	0.120	15	25	205	0.50	50
L2-R15□-10	0603	0.150	15	25	180	0.60	50
L2-R18□-10	0603	0.180	15	25	165	0.60	50
L2-R22□-10	0603	0.220	15	25	150	0.80	50
L2-R27□-10	0603	0.270	15	25	136	0.80	50
L2-R33□-10	0603	0.330	15	25	125	0.85	35
L2-R39□-10	0603	0.390	15	25	110	1.00	35
L2-R47□-10	0603	0.470	15	25	105	1.35	35
L2-R56□-10	0603	0.560	15	25	95	1.55	35
L2-R68□-10	0603	0.680	15	25	80	1.70	35
L2-R82□-10	0603	0.820	15	25	75	2.10	35
L2-1R0□-10	0603	1.000	30	10	70	0.60	25
L2-1R2□-10	0603	1.200	30	10	60	0.80	25
L2-1R5□-10	0603	1.500	30	10	55	0.80	25
L2-1R8□-10	0603	1.800	30	10	50	0.95	25
L2-2R2□-10	0603	2.200	30	10	45	1.15	15
L2-2R7□-10	0603	2.700	30	10	40	1.35	15
L2-3R3□-10	0603	3.300	30	10	38	1.55	15
L2-3R9□-10	0603	3.900	30	10	36	1.70	15
L2-4R7□-10	0603	4.700	30	10	33	2.10	15
L2-5R6□-10	0603	5.600	30	4	22	1.55	15
L2-6R8□-10	0603	6.800	30	4	20	1.70	15
L2-8R2□-10	0603	8.200	30	4	18	2.10	15
L2-100□-10	0603	10.000	30	2	17	2.55	15
L2-120□-10	0603	12.000	30	2	15	2.75	15
L2-150□-10	0603	15.000	20	1	14	1.70	15
L2-180□-10	0603	18.000	20	1	13	1.85	15

Packaging : Paper Carrier Tape (47N ~ 3R9)
 Embossed Carrier Tape (4R7 ~ 180)

Inductance tolerance :

□ : K : \pm 10%
 M : \pm 20%



RoHS Compliant

NOTE : Specifications subject to change without notice. Please check our website for latest information.

01.04.2008



SUPERWORLD ELECTRONICS (S) PTE LTD

7. IMPEDANCE VS. FREQUENCY CURVES :

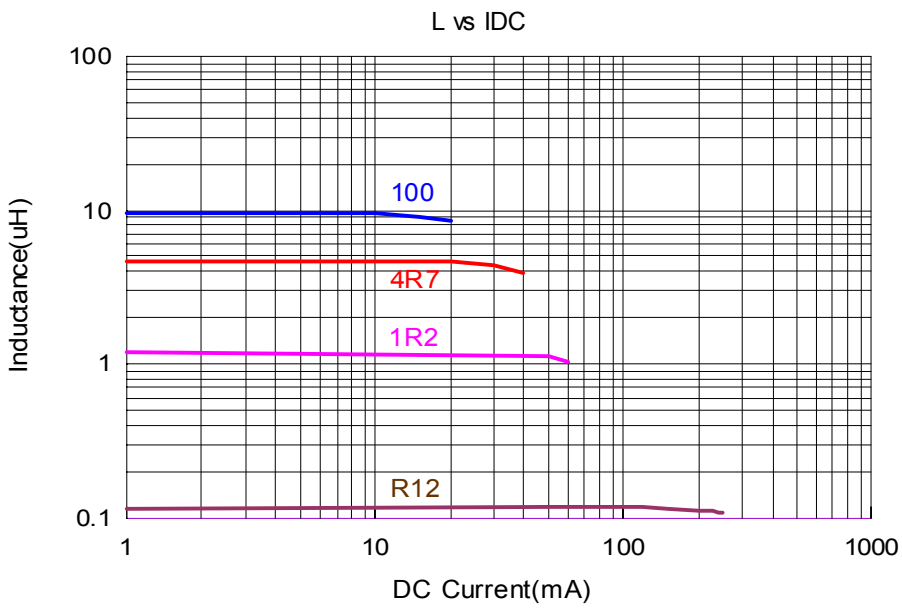
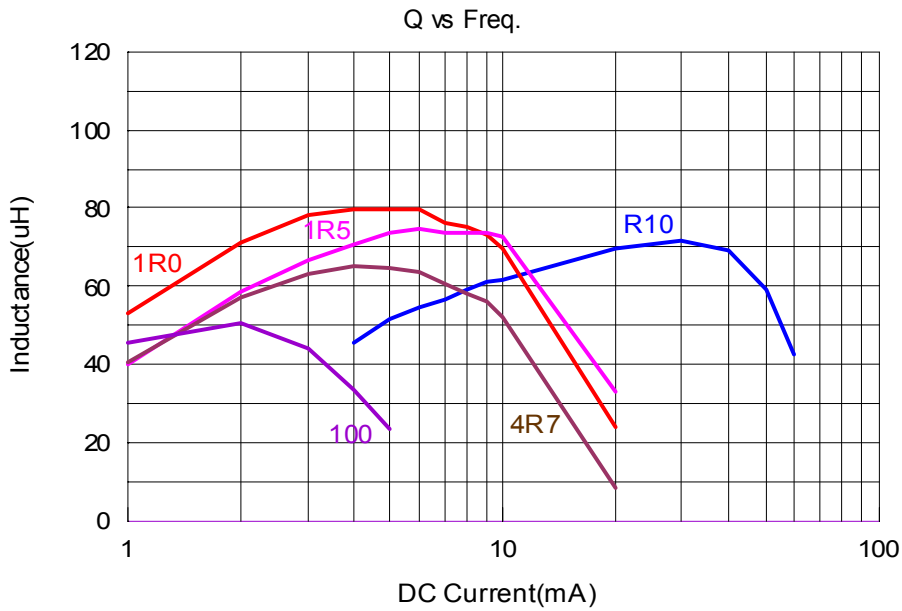

RoHS Compliant

NOTE : Specifications subject to change without notice. Please check our website for latest information.

01.04.2008



SUPERWORLD ELECTRONICS (S) PTE LTD

8. RELIABILITY & TEST CONDITION :

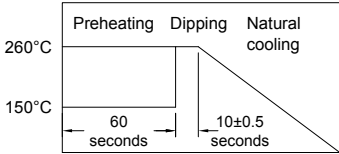
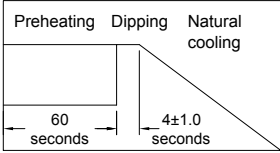
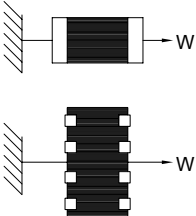
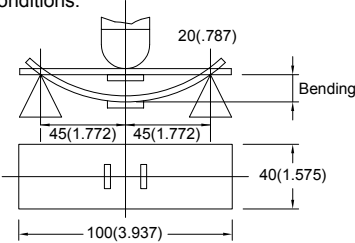
ITEM	PERFORMANCE	TEST CONDITION																											
Electrical Characteristics Test																													
Impedance	Refer to standard electrical characteristics list	HP4291A, HP4287A+16092A																											
DC Resistance		HP4338B																											
Rated Current																													
Temperature Rise Test	30°C max. (Δt)	1. Applied the allowed DC current. 2. Temperature measured by digital surface thermometer.																											
Solder Heat Resistance	No mechanical damage Remaining terminal electrode : 70% min. 	Preheat : 150°C, 60sec. Solder : Sn-Ag3.0-Cu0.5 Solder Temperature : 260±5°C Flux for lead free : rosin Dip Time : 10±0.5sec.																											
Solderability	More than 90% of the terminal electrode should be covered with solder. 	Preheat : 150°C, 60sec. Solder : Sn-Ag3.0-Cu0.5 Solder Temperature : 245±5°C Flux for lead free : rosin Dip Time : 4±1sec.																											
Terminal Strength	The terminal electrode & the dielectric must not be damaged by the forces applied on the right conditions. 	For Z / L Series : <table border="1" data-bbox="911 1088 1254 1361"> <thead> <tr> <th>Size</th> <th>Force (Kfg)</th> <th>Time (sec)</th> </tr> </thead> <tbody> <tr> <td>1</td> <td>0.2</td> <td></td> </tr> <tr> <td>2</td> <td>0.5</td> <td></td> </tr> <tr> <td>3</td> <td>0.6</td> <td></td> </tr> <tr> <td>4</td> <td>1.0</td> <td>> 25</td> </tr> <tr> <td>5</td> <td>1.0</td> <td></td> </tr> <tr> <td>6</td> <td>1.0</td> <td></td> </tr> <tr> <td>7</td> <td>1.5</td> <td></td> </tr> <tr> <td>8</td> <td>2.0</td> <td></td> </tr> </tbody> </table>	Size	Force (Kfg)	Time (sec)	1	0.2		2	0.5		3	0.6		4	1.0	> 25	5	1.0		6	1.0		7	1.5		8	2.0	
Size	Force (Kfg)	Time (sec)																											
1	0.2																												
2	0.5																												
3	0.6																												
4	1.0	> 25																											
5	1.0																												
6	1.0																												
7	1.5																												
8	2.0																												
Flexture Strength	The terminal electrode & the dielectric must not be damaged by the forces applied on the right conditions. 	Solder a chip on a test substrate, bend the substrate by 2mm (0.079in) and return.																											



RoHS Compliant

NOTE : Specifications subject to change without notice. Please check our website for latest information.

01.04.2008



SUPERWORLD ELECTRONICS (S) PTE LTD

8. RELIABILITY & TEST CONDITION :

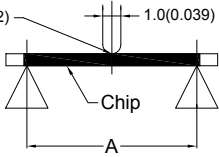
ITEM	PERFORMANCE	TEST CONDITION																		
Bending Strength	<p>The ferrite should not be damaged by forces applied on the right condition.</p> 	<p>For Z / L Series :</p> <table border="1"> <thead> <tr> <th>Series name</th> <th>mm (inches)</th> <th>P-Kgf</th> </tr> </thead> <tbody> <tr> <td>2</td> <td>0.80 (0.033)</td> <td>0.3</td> </tr> <tr> <td>3</td> <td>1.40 (0.055)</td> <td>1.0</td> </tr> <tr> <td>4</td> <td rowspan="2">2.00 (0.079)</td> <td rowspan="2">2.5</td> </tr> <tr> <td>5</td> </tr> <tr> <td>6</td> <td rowspan="3">2.70 (0.106)</td> <td rowspan="3">2.5</td> </tr> <tr> <td>7</td> </tr> <tr> <td>8</td> </tr> </tbody> </table>	Series name	mm (inches)	P-Kgf	2	0.80 (0.033)	0.3	3	1.40 (0.055)	1.0	4	2.00 (0.079)	2.5	5	6	2.70 (0.106)	2.5	7	8
Series name	mm (inches)	P-Kgf																		
2	0.80 (0.033)	0.3																		
3	1.40 (0.055)	1.0																		
4	2.00 (0.079)	2.5																		
5																				
6	2.70 (0.106)	2.5																		
7																				
8																				
Random Vibration Test	Appearance : Cracking, shipping & any other defects harmful to the characteristics should not be allowed.	<p>Frequency : 10-55-10Hz for 1 min. Amplitude : 1.52mm Directions & times : X, Y, Z directions for 2 hours. A period of 2 hours in each of 3 mutually perpendicular directions (Total 6 hours).</p>																		
Drop	Drop 10 times on a concrete floor from a height of 75cm.	No mechanical damage																		
Loading at High Temperature	<p>Appearance : No damage. Inductance : Within $\pm 10\%$ of initial value. Q : Within $\pm 30\%$ of initial value.</p>	<p>Temperature : $85 \pm 5^\circ\text{C}$ Applied Current : rated current Duration : 1008 ± 12hrs Measured at room temperature after placing for 2 to 3hrs.</p>																		
Humidity		<p>Humidity : 90~95% RH. Temperature : $40 \pm 2^\circ\text{C}$ Duration : 1008 ± 12hrs Measured at room temperature after placing for 2 to 3hrs.</p>																		
Thermal Shock	<p>Appearance : No damage. Inductance : Within $\pm 10\%$ of initial value. Q : Within $\pm 30\%$ of initial value.</p> <table border="1"> <thead> <tr> <th>Phase</th> <th>Temperature ($^\circ\text{C}$)</th> <th>Times (min.)</th> </tr> </thead> <tbody> <tr> <td>1</td> <td>$-40 \pm 2^\circ\text{C}$</td> <td>30 ± 3</td> </tr> <tr> <td>2</td> <td>$+85 \pm 5^\circ\text{C}$</td> <td>30 ± 3</td> </tr> </tbody> </table>	Phase	Temperature ($^\circ\text{C}$)	Times (min.)	1	$-40 \pm 2^\circ\text{C}$	30 ± 3	2	$+85 \pm 5^\circ\text{C}$	30 ± 3	<p>For L Series :</p> <p>Condition for 1 cycle Step1 : $-40 \pm 2^\circ\text{C}$ 30 ± 3 min. Step2 : $+85 \pm 5^\circ\text{C}$ 30 ± 3 min. Number of cycles : 100 Measured at room temperature after placing for 2 to 3hrs.</p>									
Phase	Temperature ($^\circ\text{C}$)	Times (min.)																		
1	$-40 \pm 2^\circ\text{C}$	30 ± 3																		
2	$+85 \pm 5^\circ\text{C}$	30 ± 3																		
Low temperature storage test	Measured : 100 times	<p>Temperature : $-55 \pm 2^\circ\text{C}$ Duration : 1008 ± 12hrs Measured at room temperature after placing for 2 to 3hrs.</p>																		
Drop	Drop 10 times on a concrete floor from a height of 75cm.	No mechanical damage																		

Derating Curve

For the ferrite chip bead which withstanding current over 1.5A, as the operating temperature over 85°C , the derating current information is necessary to consider with. For the detail derating of current, please refer to the Derated Current vs. Operating Temperature curve.

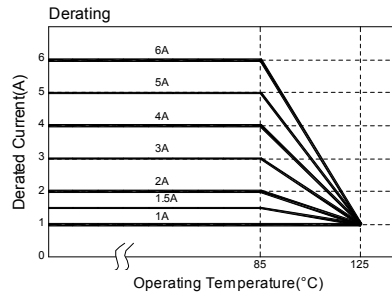

RoHS Compliant

NOTE : Specifications subject to change without notice. Please check our website for latest information.



9. SOLDERING AND MOUNTING :

9-1. Recommended PC Board Pattern

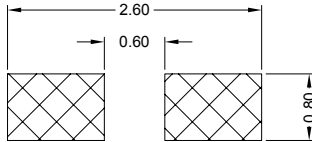

PC board should be designed so that products are not sufficient under mechanical stress as warping the board. Products shall be positioned in the sideways direction against the mechanical stress to prevent failure.

9-2. Soldering

Mildly activated rosin fluxes are preferred. The minimum amount of solder can lead to damage from the stresses caused by the difference in coefficients of expansion between solder, chip and substrate. The terminations are suitable for all wave and re-flow soldering systems. If hand soldering cannot be avoided, the preferred technique is the utilization of hot air soldering tools.

9-2.1 Lead Free Solder Re-flow :

Recommended temperature profiles for re-flow soldering in Figure 1.

9-2.2 Solder Wave :

Wave soldering is perhaps the most rigorous of surface mount soldering processes due to the steep rise in temperature seen by the circuit when immersed in the molten solder wave, typical at 230°C. Due to the risk of thermal damage to products, wave soldering of large size products is discouraged. Recommended temperature profile for wave soldering is shown in Fig. 2

9-2.3 Soldering Iron (Figure 3) :

Products attachment with soldering iron is discouraged due to the inherent process control limitations. In the event that a soldering iron must be employed the following precautions are recommended.

Note :

- a) Preheat circuit and products to 150°C.
- b) 350°C tip temperature (max)
- c) Never contact the ceramic with the iron tip
- d) 1.0mm tip diameter (max)
- e) Use a 20 watt soldering iron with tip diameter of 1.0mm
- f) Limit soldering time to 3 secs.

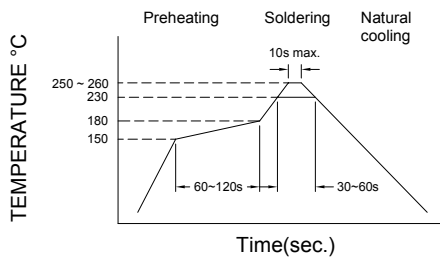

Figure 1. Re-flow Soldering

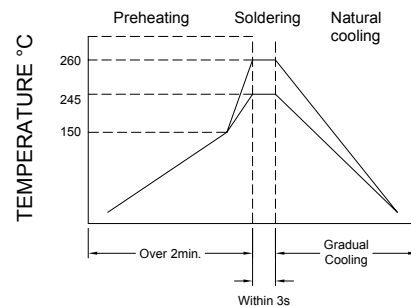

Figure 2. Wave Soldering

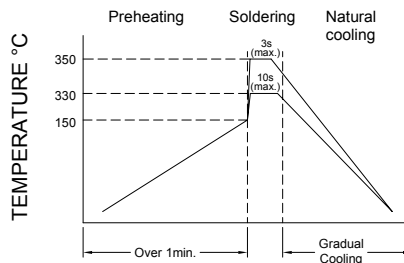

Figure 3. Hand Soldering



RoHS Compliant

NOTE : Specifications subject to change without notice. Please check our website for latest information.

01.04.2008



SUPERWORLD ELECTRONICS (S) PTE LTD

9-3. Solder Volume

Accordingly increasing the solder volume, the mechanical stress to product is also increased. Exceeding solder volume may cause the failure of mechanical or electrical performance. Solder shall be used not to be exceed as shown in Fig. 4.

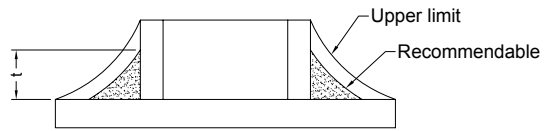

Figure 4



RoHS Compliant

NOTE : Specifications subject to change without notice. Please check our website for latest information.

01.04.2008



SUPERWORLD ELECTRONICS (S) PTE LTD

10. PACKAGING INFORMATION :

10-1. Reel Dimension

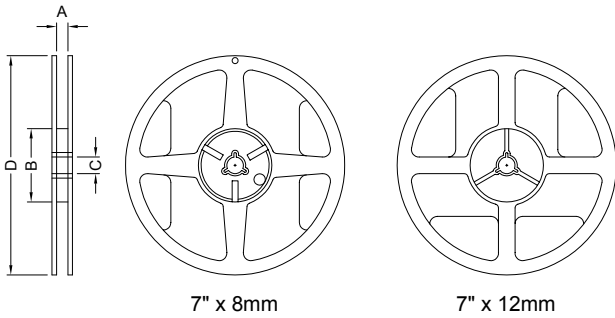

Type	A(mm)	B(mm)	C(mm)	D(mm)
7" x 8mm	9.0±0.5	60.0±2.0	13.5±0.5	178.0±2.0
7" x 12mm	13.5±0.5	60.0±2.0	13.5±0.5	178.0±2.0

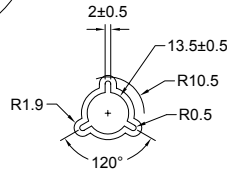

10-2 Tape Dimension / 8mm

Material : Paper

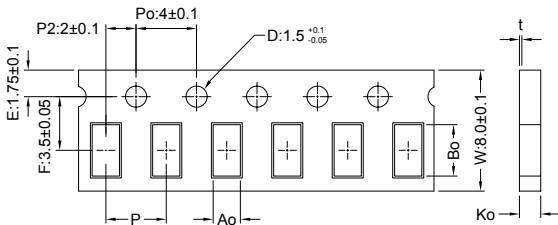

Series	Size	Bo(mm)	Ao(mm)	Ko(mm)	P(mm)	t(mm)	D1(mm)
Z / L	1	1.12±0.05	0.67±0.05	0.54±0.05	2.0±0.1	0.23±0.05	none
	2	1.80±0.05	1.05±0.05	0.95±0.05	4.0±0.1	0.95±0.05	none
	3(09)	2.30±0.05	1.50±0.05	0.95±0.05	4.0±0.1	0.95±0.05	none

Material : Plastic

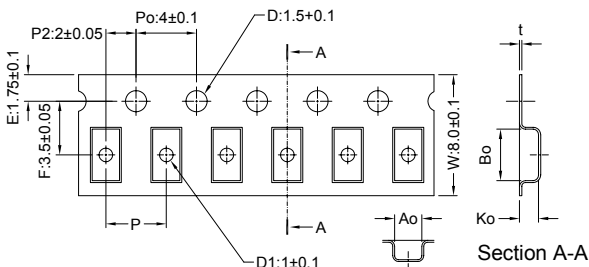

Series	Size	Bo(mm)	Ao(mm)	Ko(mm)	P(mm)	t(mm)	D1(mm)
Z / L	2	1.80±0.10	1.01±0.10	1.02±0.10	4.0±0.1	0.22±0.05	none
	3(09)	2.25±0.10	1.42±0.10	1.04±0.10	4.0±0.1	0.22±0.05	1.0±0.1
	3(12)	2.35±0.10	1.50±0.10	1.45±0.10	4.0±0.1	0.22±0.05	1.0±0.1
	4	3.50±0.10	1.88±0.10	1.27±0.10	4.0±0.1	0.22±0.05	1.0±0.1
	5	3.42±0.10	2.77±0.10	1.55±0.10	4.0±0.1	0.22±0.05	1.0±0.1

10-2.1 Tape Dimension / 12mm

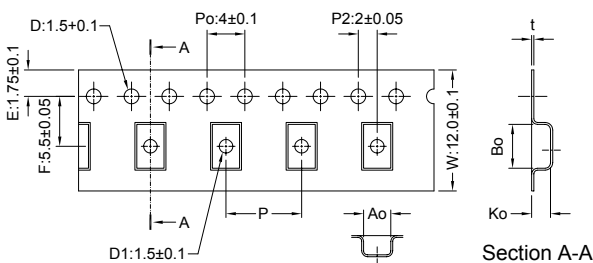

Series	Size	Bo(mm)	Ao(mm)	Ko(mm)	P(mm)	t(mm)	D1(mm)
Z / L	6	4.95±0.1	1.93±0.1	1.93±0.1	4.0±0.1	0.24±0.05	1.5±0.1
	7	4.95±0.1	3.66±0.1	1.85±0.1	8.0±0.1	0.24±0.05	1.5±0.1
	8	6.10±0.1	5.40±0.1	2.00±0.1	8.0±0.1	0.30±0.05	1.5±0.1



RoHS Compliant

NOTE : Specifications subject to change without notice. Please check our website for latest information.



10-3. Packaging Quantity

Chip Size	8	7	6	5	4	3 (12)	3 (09)	2	1
Chip / Reel	1000	1000	2000	2500	3000	2000	4000	4000	10000
Inner Box	4000	4000	8000	12500	15000	10000	20000	20000	50000
Middle Box	20000	20000	40000	62500	75000	50000	100000	100000	250000
Carton	40000	40000	80000	125000	150000	100000	200000	200000	500000
Bulk (Bags)	7000	12000	20000	30000	50000	100000	150000	200000	300000

10-4. Tearing Off Force

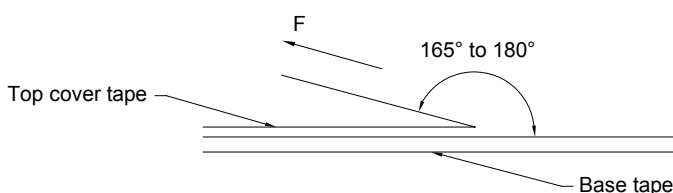

The force for tearing off cover tape is 15 to 60 grams in the arrow direction under the following conditions.

Room Temp. (°C)	Room Humidity (%)	Room atm (hPa)	Tearing Speed (mm/min)
5~35	45~85	860~1060	300

Application Notice

1. Storage Conditions :

To maintain the solderability of terminal electrodes :

- Temperature and humidity conditions : 10 ~ 40°C and 30 ~ 70% RH.
- Recommended products should be used within 6 months from the time of delivery.
- The packaging material should be kept where no chlorine or sulfur exists in the air.

2. Transportation :

- Products should be handled with care to avoid damage or contamination from perspiration and skin oils.
- The use of tweezers or vacuum pick up is strongly recommended for individual components.
- Bulk handling should ensure that abrasion and mechanical shock are minimized.



RoHS Compliant

NOTE : Specifications subject to change without notice. Please check our website for latest information.

01.04.2008



SUPERWORLD ELECTRONICS (S) PTE LTD