

GSC1118

1A Positive Low Dropout Fixed-mode Regulator With EN Function

Description

The GSC1118 is a low dropout positive fixed-mode regulator with minimum of 1A output current capability. The product is specifically designed to provide well-regulated supply for low voltage IC applications such as high-speed bus termination and low current 3.3V logic supply. GSC1118 is also well suited for other applications such as VGA cards. The product is guaranteed to have <1.4V dropout at full load current making it ideal to provide well regulated outputs 1.5V to 12V with up to 18V input supply. The product offers a TTL-Logic compatible enable pin.

Features

- 1.4V maximum dropout voltage at full load current
- Built-in thermal shutdown
- Output current limiting
- Fixed output voltage 1.5V, 1.8V, 2.5V, 3.3V, 5.0V, 9.0V, 12V
- Fast transient response
- Good noise rejection
- Enable function

Applications

- PC peripheral
- Communication
- CDROM..

Package Dimensions

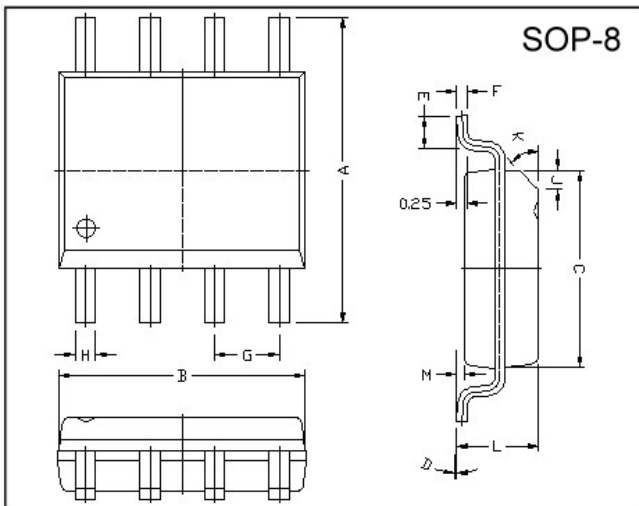

Marking :

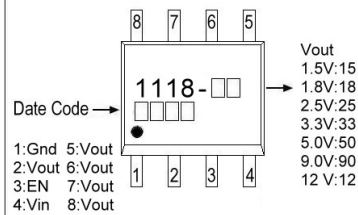

REF.	Millimeter		REF.	Millimeter	
	Min.	Max.		Min.	Max.
A	5.80	6.20	M	0.10	0.25
B	4.80	5.00	H	0.35	0.49
C	3.80	4.00	L	1.35	1.75
D	0°	8°	J	0.375 REF.	
E	0.40	0.90	K	45°	
F	0.19	0.25	G	1.27 TYP.	

Typical Circuit

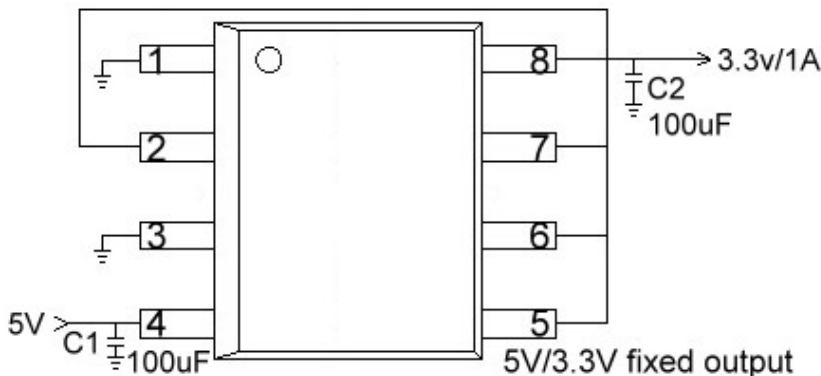

Pin Descriptions

Name	Description
GND	Ground
VOUT	The output of the regulator. A minimum of 10uF capacitor must be connected from this pin to ground to insure stability.
VIN	The input pin of regulator. Typically a large storage capacitor is connected from this pin to ground to insure that the input voltage does not sag below the minimum dropout voltage during the load transient response. This pin must always be 1.3V higher than VOUT in order for the device to regulate properly.
EN	This input pin of regulator. TTL/CMOS compatible input Logic high= disable output, Logic Low or open= output enable. (internal pull-down resistor~100K).
NC	No connection.

Absolute Maximum Ratings

Symbol	Parameter	Ratings	Unit
VIN	DC Supply Voltage	-0.3 to 18	V
VEN	Enable Pin Voltage	7	V
PD	Power Dissipation	Internally Limited	
TST	Storage Temperature Range	-65 ~ + 150	°C
TOP	Operating Junction Temperature Range	0 ~ + 150	°C

Electrical Characteristics (Under operating Conditions)

Parameter	Conditions	Min	Typ	Max	Unit
Output Voltage	GSC1118-15 Io=10mA, Tj =25°C, 3.0V ≤ VIN ≤15V	1.470	1.500	1.530	V
	GSC1118-18 Io=10mA, Tj =25°C, 3.3V ≤ VIN ≤15V	1.764	1.800	1.836	V
	GSC1118-25 Io=10mA, Tj =25°C, 4.0V ≤ VIN ≤15V	2.450	2.500	2.550	V
	GSC1118-33 Io=10mA, Tj =25°C, 4.8V ≤ VIN ≤15V	3.235	3.300	3.365	V
	GSC1118-50 Io=10mA, Tj =25°C, 6.5V ≤ VIN ≤15V	4.900	5.000	5.100	V
	GSC1118-90 Io=10mA, Tj =25°C, 10.5V ≤ VIN ≤18	8.820	9.000	9.180	V
	GSC1118-12 Io=10mA, Tj =25°C, 13.5V ≤ VIN ≤18V	11.760	12.00	12.24	V
Line Regulator	GSC1118-XX Io=10mA, Tj =25°C, VOUT+1.5 < VIN <18V	-	-	0.2	%
Load Regulation	GSC1118-15 VIN=3.0V, 0mA < Io <1A, Tj=25°C, (Note 1, 2)	-	12	15	mV
	GSC1118-18 VIN=3.3V, 0mA < Io <1A, Tj=25°C, (Note 1, 2)	-	15	18	mV
	GSC1118-25 VIN=4.0V, 0mA < Io <1A, Tj=25°C, (Note 1, 2)	-	20	25	mV
	GSC1118-33 VIN=5.0V, 0mA < Io <1A, Tj=25°C, (Note 1, 2)	-	26	33	mV
	GSC1118-50 VIN=8.0V, 0mA < Io <1A, Tj=25°C, (Note 1, 2)	-	40	50	mV
	GSC1118-90 VIN=12.0V, 0mA < Io <1A, Tj=25°C, (Note 1, 2)	-	70	90	mV
	GSC1118-12 VIN=15.0V, 0mA < Io <1A, Tj=25°C, (Note 1, 2)	-	100	120	%
Dropout Voltage (VIN-VOUT)	GSC1118-XX Io=1A, ΔVOUT=0.1 VOUT	-	1.3	1.4	V
Current Limit	GSC1118-XX (VIN-VOUT)=5V	1.1	-	-	A
Minimum Load Current	GSC1118-XX 0°C ≤ Tj ≤ 125°C	-	5	10	mA
Enable Input Voltage VEN	Logic Low (ON)	-	-	0.8	V
	Logic High (OFF)	1.6	-	-	
Enable Input Current IEN	VEN=0.8V	-	-	10	μA
	VEN=2.0V	-	-	80	
Thermal Regulation	TA=25°C, 30ms pulse	-	0.008	0.04	%/W
Ripple Rejection	F=120Hz, COUT=25uF, Tantalum, Io=1A				
	GSC1118-XX VIN=VOUT+3V	-	60	70	dB
Temperature Stability	Io=10mA	-	0.5	-	%
θJA Thermal Resistance Junction-to-Ambient (No heat sink ;No air flow)		-	150	-	°C/W
θJC Thermal Resistance Junction-to-Case	Control Circuitry/Power Transistor	-	25	-	°C/W

Note 1: See thermal regulation specifications for changes in output voltage due to heating effects. Line and load regulation are measured at a constant junction temperature by low duty cycle pulse testing. Load regulation is measured at the output lead=1/8" from the package.

Note 2: Line and load regulations are guaranteed up to the maximum power dissipation of 15W. Power dissipation is determined by the input/output differential and the output current. Guaranteed maximum power dissipation will not be available over the full input/output range

Note 3: Quiescent current is defined as the minimum output current required to maintain regulation. At 12V input/output differential the device is guaranteed to regulate if the output current is greater than 10mA.

Typical Performance Characteristics

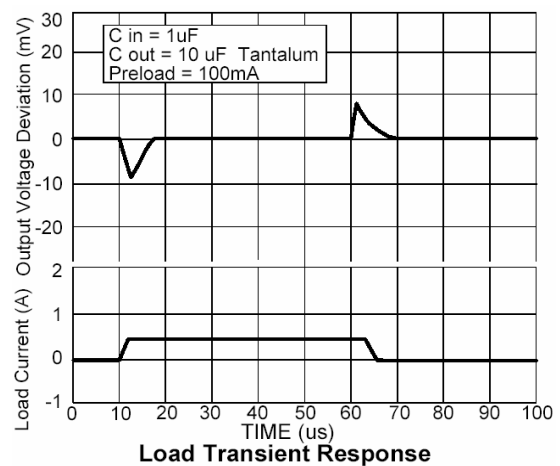
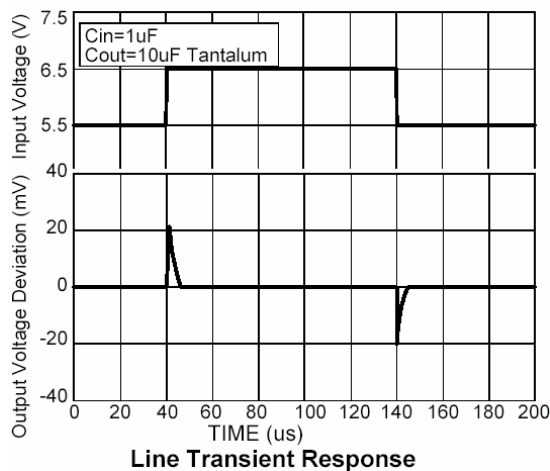
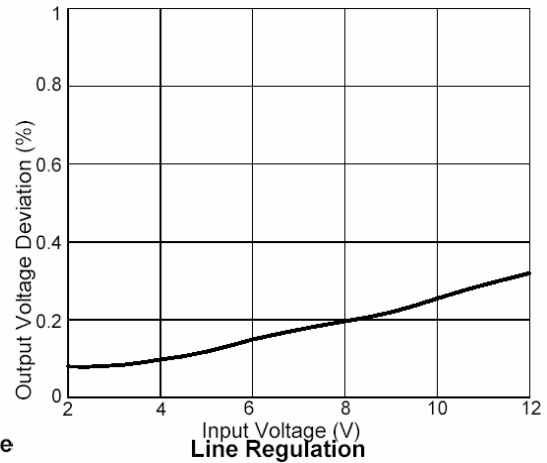
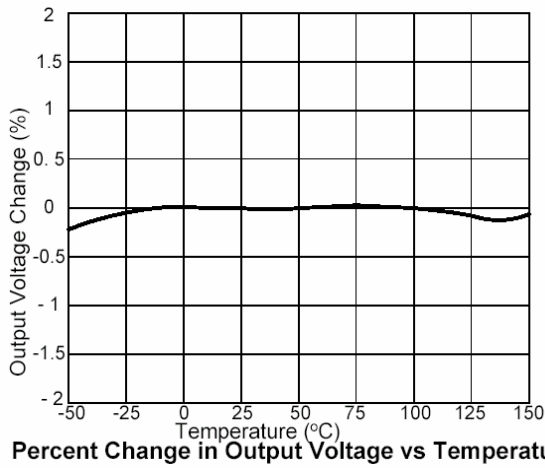
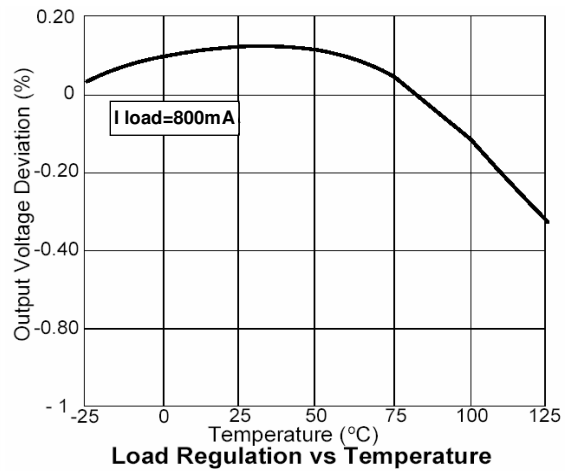
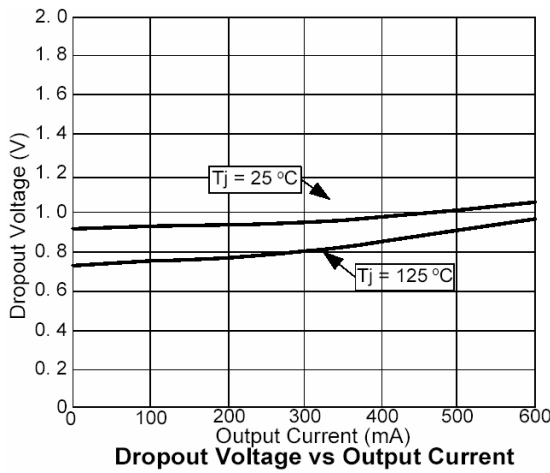

Important Notice:

- All rights are reserved. Reproduction in whole or in part is prohibited without the prior written approval of GTM.
- GTM reserves the right to make changes to its products without notice.
- GTM semiconductor products are not warranted to be suitable for use in life-support Applications, or systems.
- GTM assumes no liability for any consequence of customer product design, infringement of patents, or application assistance.

Head Office And Factory:

- **Taiwan:** No. 17-1 Tatung Rd. Fu Kou Hsin-Chu Industrial Park, Hsin-Chu, Taiwan, R. O. C.
- TEL : 886-3-597-7061 FAX : 886-3-597-9220, 597-0785
- **China:** (201203) No.255, Jang-Jiang Tsai-Lueng RD. , Pu-Dung-Hsin District, Shang-Hai City, China
- TEL : 86-21-5895-7671 ~ 4 FAX : 86-21-38950165