



QL63F5S-A/B/C InGaAlP Laser Diode

Ver. 3 2006

◆ OVERVIEW

QL63F5S-A/B/C is a MOCVD grown 635nm band *InGaAlP* laser diode with quantum well structure. It's an attractive light source, with a typical light output power of 10mW for optoelectronic devices such as Optical Leveler and Modules.

◆ APPLICATION

- Laser Pointer
- Bar Code Scanner
- Laser Module

◆ FEATURES

- Visible Light Output : $\lambda_p = 635 \text{ nm}$
- Optical Power Output : 10mW CW
- Package Type : TO-18 (5.6mm ϕ)
- Built-in Photo Diode for Monitoring Laser Diode

◆ ELECTRICAL CONNECTION

Bottom View

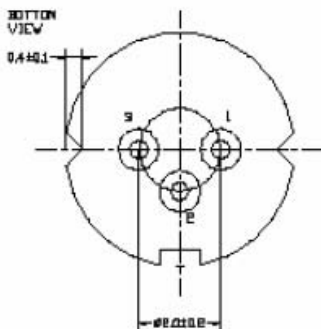

Pin Configuration

A	LD cathode, PD anode (Fig. 1)
B	LD, PD anode (Fig. 2)
C	LD anode, PD cathode (Fig. 3)

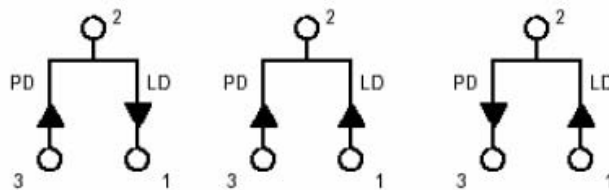

Fig. 1
QL63F5SA

Fig. 2
QL63F5SB

Fig. 3
QL63F5SC



◆ ABSOLUTE MAXIMUM RATING at Tc=25°C

Items	Symbols	Values	Unit
Optical Output Power	P	12	mW
Laser Diode Reverse Voltage	V	2	V
Photo Diode Reverse Voltage	V	30	V
Operating Temperature	Topr	-10 ~ +50	°C
Storage Temperature	Tstg	-40 ~ +85	°C

◆ ELECTRICAL and OPTICAL CHARACTERISTICS at Tc=25°C ¹⁾

Items	Symbols	Min.	Typ.	Max.	Unit	Condition
Optical Output Power	Po	-	10	-	mW	-
Threshold Current	Ith	-	35	50	mA	-
Operating Current	Iop	-	55	75	mA	Po=10mW
Operating Voltage	Vop	-	2.2	2.5	V	Po=10mW
Lasing Wavelength	λ_p	-	637	645	nm	Po=10mW
Beam Divergence ³⁾	$\theta_{ }$	6	8	11	deg	Po=10mW
	θ_{\perp}	25	30	35	deg	Po=10mW
Beam Angle	$\Delta\theta_{ }$	-	-	± 1.5	deg	Po=10mW
	$\Delta\theta_{\perp}$	-	-	± 2.5	deg	Po=10mW
Monitor Current	Im	0.05	0.15	0.3	mA	Po=10mW
Optical Distance	$\Delta X, \Delta Y, \Delta Z$	-	-	± 60	μm	-

1) Initial values

3) Full angle at half maximum

NOTICE : QL63F5S-A/B/C to be operated on APC

The above product specifications are subject to change without notice.



◆ EXAMPLE of REPRESENTATIVE CHARACTERISTICS

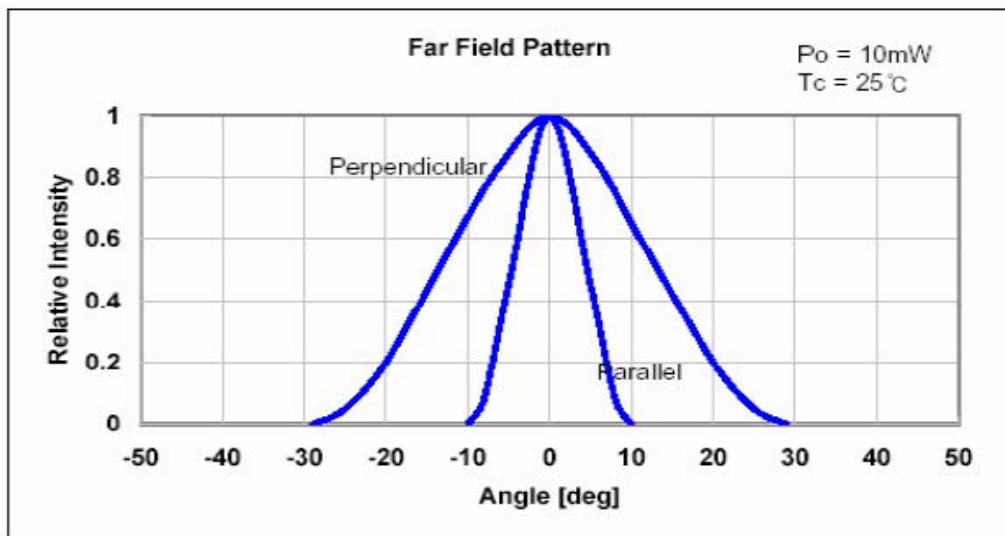
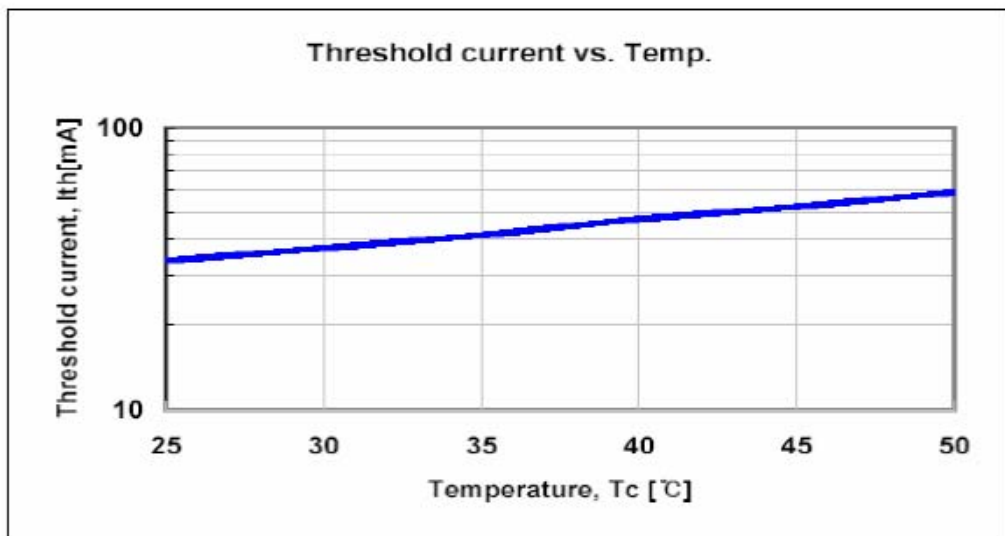
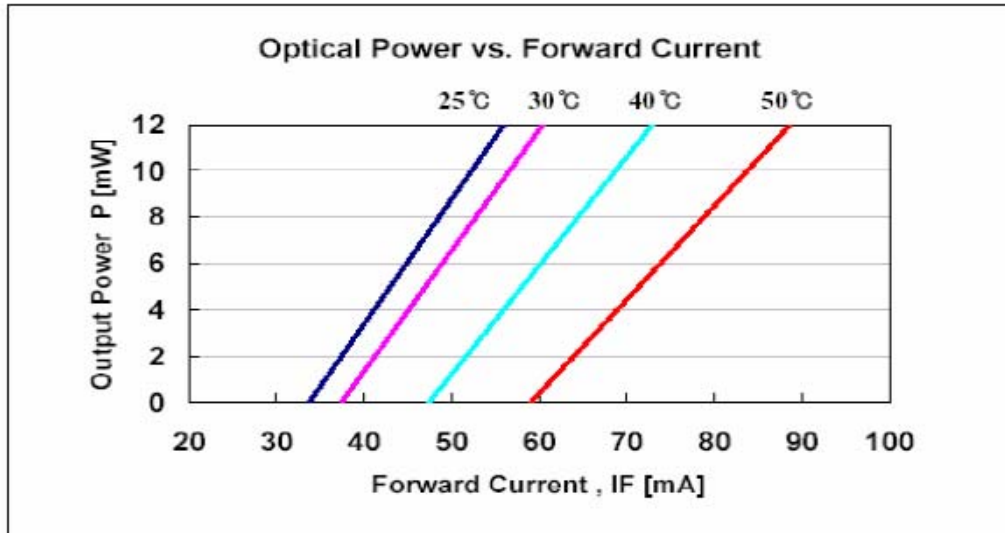

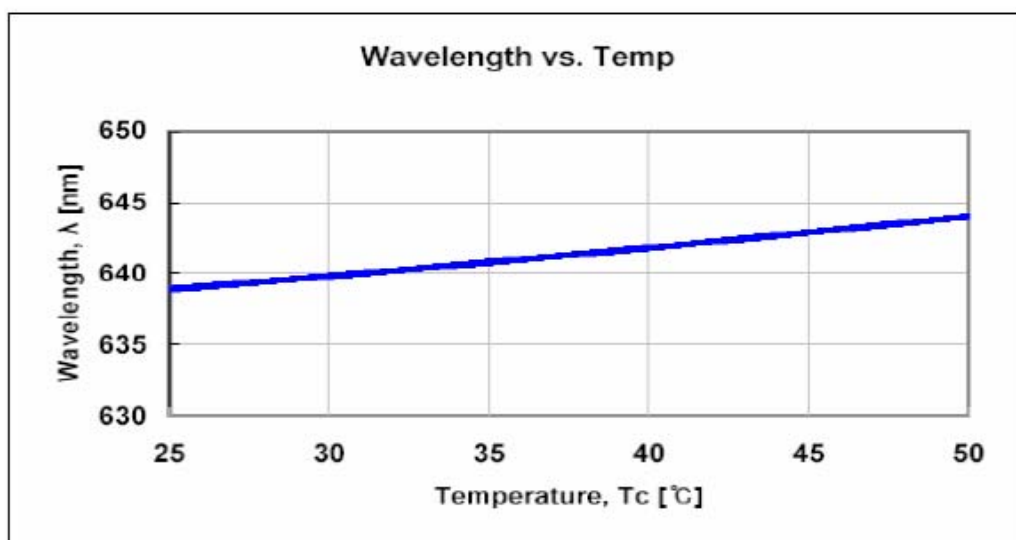
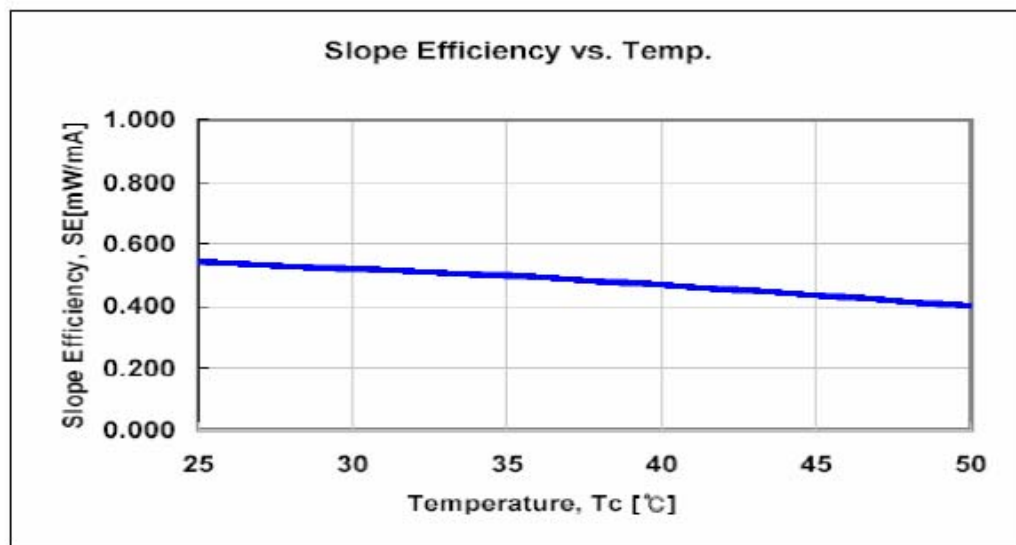
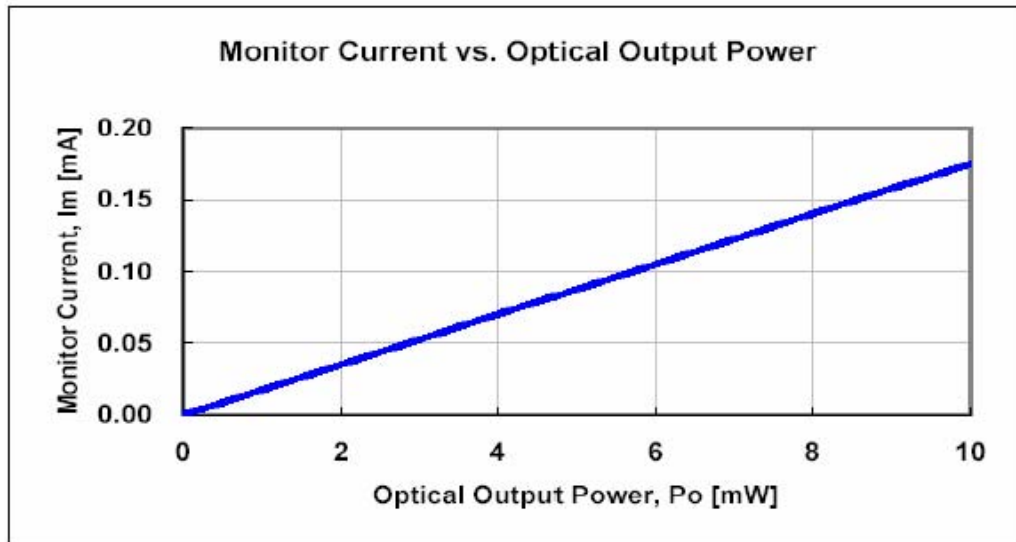



◆ PACKAGE DIMENSION

