



Low Cost Silicon Double Balanced HMIC™ Mixer, 700 - 1200 MHz

Features

- 6.5 dB Typical Conversion Loss
- +3 to +7 dBm LO Drive
- HMIC IC Process
- Silicon Low Barrier Schottky Barrier Diodes
- DC - 400 MHz IF Bandwidth
- Low Cost Miniature Plastic Package

Description

M/A-COM's MA4EX950L-1225 is a silicon monolithic 700-1200 MHz double balanced mixer in a low-cost miniature surface mount SOT-25 package. The die uses M/A-COM's unique HMIC™ silicon / glass process to realize low loss passive elements while retaining the advantages of low barrier silicon Schottky barrier diodes.

Applications

These mixers are well suited for high volume wireless and cellular applications where small size and repeatability are required. Typical applications include frequency conversion, modulation, and demodulation in wireless receivers and transmitters.

SOT-25 Outline

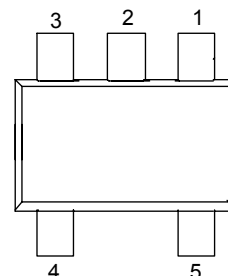

Pin Configuration

PIN	Function	PIN	Function
1	RF	4	Gnd
2	Gnd	5	IF
3	LO	—	—

Ordering Information

Model No.	Package
MA4EX950L-1225	Tube
MA4EX950L-1225T	Tape and Reel

Electrical Specifications @ T_A = +25°C

Parameter	Frequency Range	Test Conditions	Units	Min.	Typ.	Max.
Conversion Loss	850 MHz 0.7 – 1.2 GHz	LO Drive = +3 → +7 dBm RF = -10 dBm, IF = 60 MHz	dB		6.5 8.0	7.5 10.5
L - R Isolation	850 MHz 0.7 – 1.2 GHz	LO Drive = +5 dBm RF Level = -10 dBm	dB	-	28.0 25.0	
L - I Isolation	850 MHz 0.7 – 1.2 GHz	LO Drive = +5 dBm RF Level = -10 dBm	dB	-	27.0 26.0	
R - I Isolation	850 MHz 0.7 – 1.2 GHz	LO Drive = +5 dBm RF Level = -10 dBm	dB	-	28.0 24.0	
LO V _{SWR}	850 MHz 0.7 – 1.2 GHz	LO Drive = +5 dBm RF Level = -10 dBm			2.4 2.8	- -
RF V _{SWR}	850 MHz 0.7 – 1.2 GHz	LO Drive = +5 dBm RF Level = -10 dBm			1.3 2.7	- -
IF V _{SWR}	DC - 400 MHz	LO Drive = +5 dBm IF Level = -10 dBm			1.4	-
Input IP ₃	850 MHz 0.7 – 1.2 GHz	LO Drive = +3 → +7 dBm RF = -10 dBm, IF = 60 MHz	dBm	11.0 9.0	13.2 14.0	
Input 1 dB Compression	850 MHz 0.7 – 1.2 GHz	LO Drive = +3 → +7 dBm RF = -10 dBm, IF = 60 MHz	dBm	-	0 +1.5	
IF 1 dB Bandwidth	DC - 400 MHz	LO = 4650 MHz @ +5dBm	MHz	0		400

Specifications subject to change without notice.

V 2.0

■ North America: Tel. (800) 366-2266, Fax (800) 618-8883

■ Asia/Pacific: Tel. +81-44-844-8296, Fax +81-44-844-8298

■ Europe: Tel. +44 (1344) 869 595, Fax +44 (1344) 300 020

Visit www.macom.com for additional data sheets and product information.

tyco / Electronics

1
M/A-COM

Case Style

SOT-25

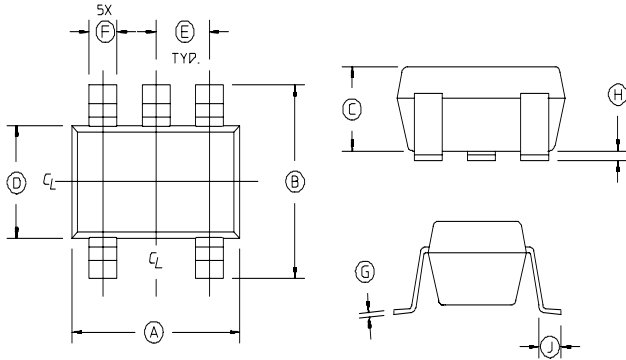

SOT-25^{1, 2}

DIM	INCHES		MILLIMETERS	
	MIN	MAX	MIN	MAX
A	.1103	.1181	2.80	3.10
B	.1023	.1181	2.6	3.00
C	0.0355	.0512	0.9	1.30
D	0.0591	.0669	1.5	1.70
E	.0374 REF.		0.95 REF.	
F	.0138	.0197	.35	.50
G	.0031	0.0079	.08	0.2
H	.0002	.0059	.05	.15
J	.0138	.0216	.35	.55

1. Dimensions do not include mold flas, protrusion or gate burrs which shall not exceed 0.0098 in (.25 mm) per side.
2. Leads Coplanarity should be 0.003 (0.08) max.

Absolute Maximum Rating¹

Parameter	Maximum Ratings
Operating Temperature	-65°C to +125°C
Storage Temperature	-65°C to +150°C
Incident LO Power	+20 dBm
Incident RF Power	+20 dBm
Mounting Temperature	+ 235°C for 10 seconds

1. Exceeding these limits may cause permanent damage.

Schematic

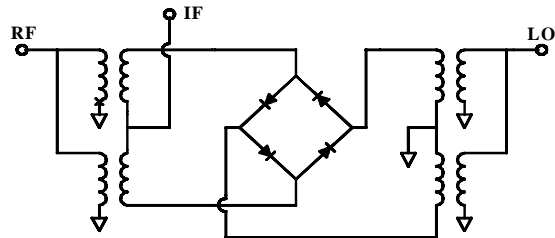

Typical Performance Curves

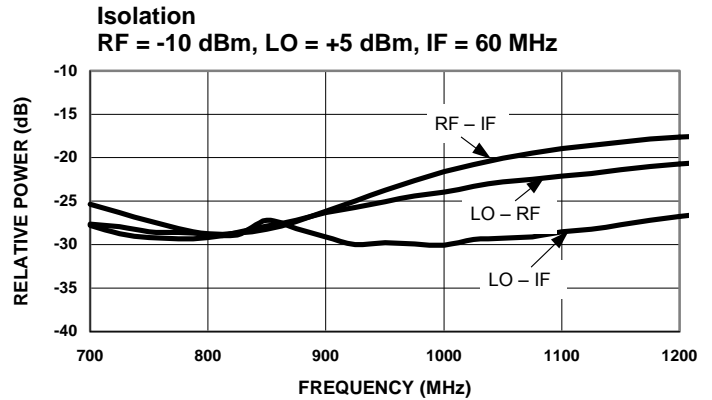
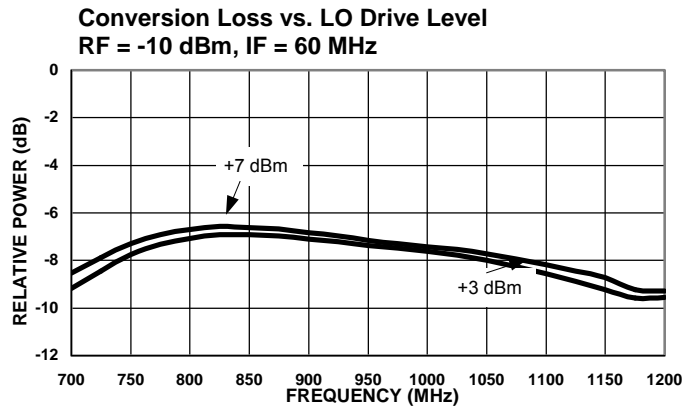

Specifications subject to change without notice.

- North America: Tel. (800) 366-2266, Fax (800) 618-8883
- Asia/Pacific: Tel.+81-44-844-8296, Fax +81-44-844-8298
- Europe: Tel. +44 (1344) 869 595, Fax+44 (1344) 300 020

Visit www.macom.com for additional data sheets and product information.

Typical Performance Curves (Cont'd)

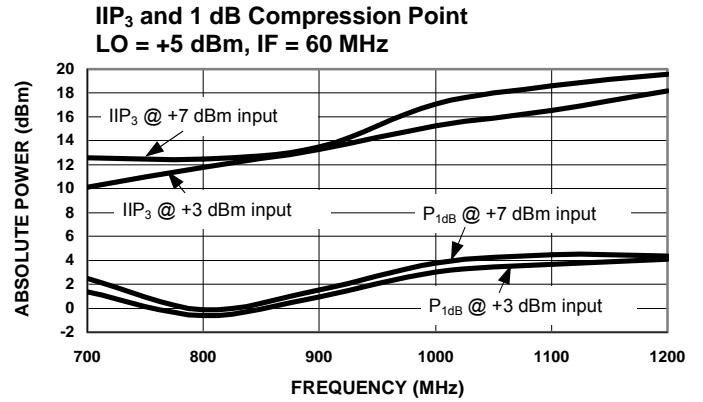
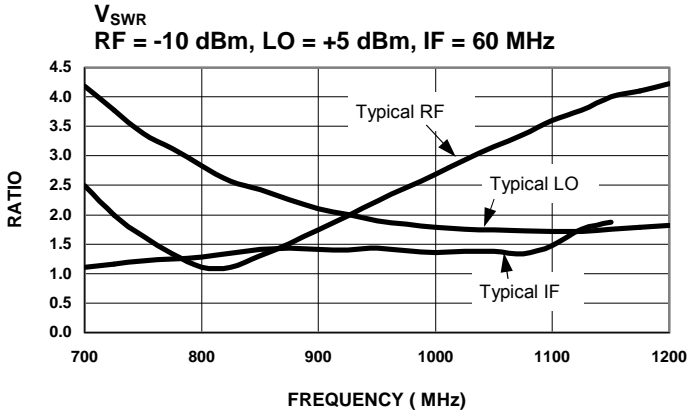

Specifications subject to change without notice.

- North America: Tel. (800) 366-2266, Fax (800) 618-8883
- Asia/Pacific: Tel.+81-44-844-8296, Fax +81-44-844-8298
- Europe: Tel. +44 (1344) 869 595, Fax+44 (1344) 300 020

Visit www.macom.com for additional data sheets and product information.