

ProLite 1W SMD Emitter

BTP-99XXCG-XX-X/W

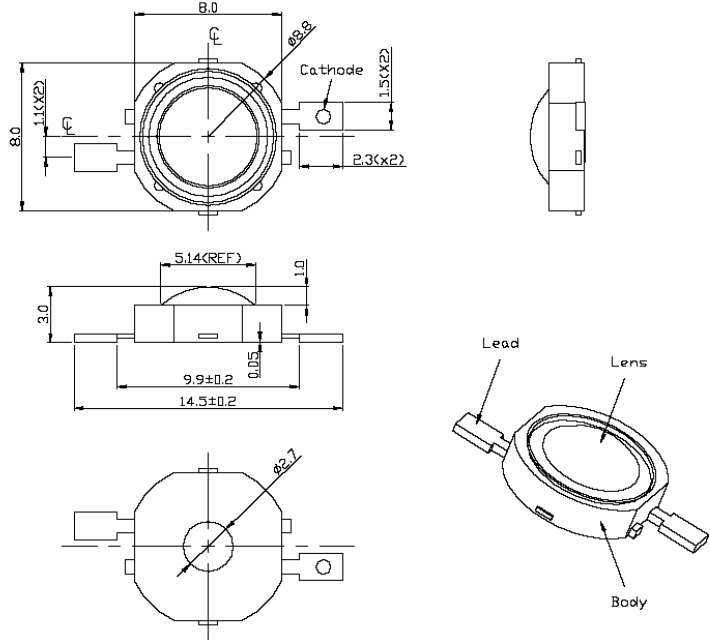

Package Dimension



Features

- Highest Lumen Per Watt
- Long Operational Life
- White Housing
- Superior ESD Protection
- Instant Light (less than 100ns)
- Compatible to Luxeon's "Lambertian"
- True SMD Emitter
- IR Reflow Soldering Process

Applications

- Accent Light/Down Light/Spot Light
- Automotive Exterior/Interior Light
- Large Area LCD Backlights
- Marine/Miner's Lighting
- Portable Flashlight/ General Lighting

Note: Lens is low dome profile

Tolerance: ± see spec Unit: mm

Optical Characteristics at $T_J=25^\circ\text{C}$, $I_F=350\text{mA}$

PART NUMBER	Emitting Color	LED Chip Material	Lens Color	Wavelength (nm)		Drive Voltage @ 350mA	Luminous Flux (lm) @350mA	VIEW ANGLE $2\theta_{1/2}$ (deg)
				CCT (K) Range				
				Min	Max	Typ.	Typ.	
BTP-99NRCG-XX-X/W	Normal Red	AllnGaP	Water Clear	620	635	2.40V	30 lm	140
BTP-99AMCG-XX-X/W	Amber	AllnGaP	Water Clear	610	620	2.40V	36 lm	140
BTP-99YECG-XX-X/W	Yellow	AllnGaP	Water Clear	585	595	2.40V	30 lm	140
BTP-99BLCG-XX-X/W	Blue	AllnGaN	Water Clear	460	475	3.50V	10 lm	140
BTP-99PGCG-XX-X/W	Green	AllnGaN	Water Clear	520	540	3.50V	30 lm	140
BTP-99WWCG-XX-X/W	Warm White	AllnGaN	Water Clear	2800K	3800K	3.50V	20 lm	140
BTP-99WHCG-XX-X/W	White	AllnGaN	Water Clear	5000K	8000K	3.50V	25 lm	140

Notes:

- 1) Picture for illustration purpose only. Please refer to outline dimension for actual package size.
- 2) Flux is measured with the accuracy of $\pm 15\%$. Please refer to Flux Selection Guide
- 3) CCT is measured with the accuracy of $\pm 400\text{K}$. Please refer to CCT Selection Guide
- 4) V_f is measured with the accuracy of $\pm 0.15\text{V}$. Please refer to V_f Selection Guide

ProLite 1W SMD Emitter

BTP-99XXCG-XX-X/W

Absolute Maximum Ratings at $T_J=25^{\circ}\text{C}$

Parameter	Red/Amber/Yellow	White/Blue/Green
Power Dissipation (W)	1.00	1.22
DC Forward Current (mA) ^[1]	350	350
Peak Pulsed Forward Current (mA) ^[4]	500	500
Average Forward Current (mA)	350	350
Reverse Voltage (V)	5	5
Reverse Current (uA)	50	50
ESD Sensitivity (V) ^[2]	16,000	16,000
LED Junction Temperature at 350mA (°C) ^[3]	120	135
Thermal Resistance Junction to Board (°C/W)	15	15
Temperature Coefficient of V_F (mV/°C)	-2	-2
Storage Temperature (°C)	-40 to +105	-40 to +105
Operating Temperature (°C)	-40 to +105	-40 to +105
Lead Soldering Temperature (°C) ^[4]	260°C for 5 seconds max	260°C for 5 seconds max

Application Notes:

1. Proper forward current must be observed to maintain the junction temperature below maximum rating
2. Although all products listed are class two ESD protection (+/- 16KV by HBM mode), care must be fully taken when handling products
3. Specification is subjected to change for improvements without notice.
4. Test conditions: $t_p \leq 10\mu\text{s}$, duty cycle = 0.005
5. CAUTION: When lighting up, the emitter will become very hot if it is not attached to a heat sink. Please provide proper heat management to prevent damage to the emitter.



WARNING

This range of LEDs is produced with die having a high radiant flux. Care must be taken when viewing the product at close range as the light may be intense enough to cause damage to the human eye.

Note: Industry standard procedures regarding static must be observed when handling this product.

ProLite 1W SMD Emitter

BTP-99XXCG-XX-X/W

CCT, Flux and V_F Selection Guide (@ $T_J = 25^\circ\text{C}$, $I_F = 350\text{mA}$)

BTP-99XXCG-XX-X/W

White Housing

Wavelength Ranks Selection

Color	Bin	$\lambda_D(\text{nm})$	
		Min	Max
Blue	B5	460	465
	B6	465	470
	B7	470	475
	XX	460 – 475	
Green	G6	515	520
	G7	520	525
	G8	525	530
	G9	530	535
	XX	515 – 535	
Red	XX	620 – 630	
Amber	XX	610 – 620	
Yellow	XX	585 – 595	

Flux Ranks Selection

Color	Bin	Flux (lumens)
Blue	H	4.5~6
	J	6~8
	K	8~10
	X	Default Full Range
Red Amber Yellow Green White	M	14~18
	N	18~23
	P	23~30
	Q	30~39
	R	39~50
	X	Default Full Range

CCT Ranks Selection

Color Temp	Bin	CCT(K)	
		Min	Max
Warm White	00	2800	3300
	01	3300	3800
	XX	2800K – 3800K	
White	02	5000	6000
	03	6000	7000
	04	7000	8000
	XX	5000K – 8000K	

V_F Ranks Selection

Color	Bin	V_F (V)	
		Min	Max
Red Amber Yellow	V04	2.0	2.2
	V05	2.2	2.4
	V06	2.4	2.6
	V07	2.6	2.8
	VXX(Full)	2.0~2.8	
White Blue Green	V08	2.8	3.0
	V09	3.0	3.2
	V10	3.2	3.4
	V11	3.4	3.6
	V12	3.6	3.8
	VXX(Full)	2.8~3.8	

(Please specify on order, otherwise, default full range of V_F)

Typical Radiation Pattern

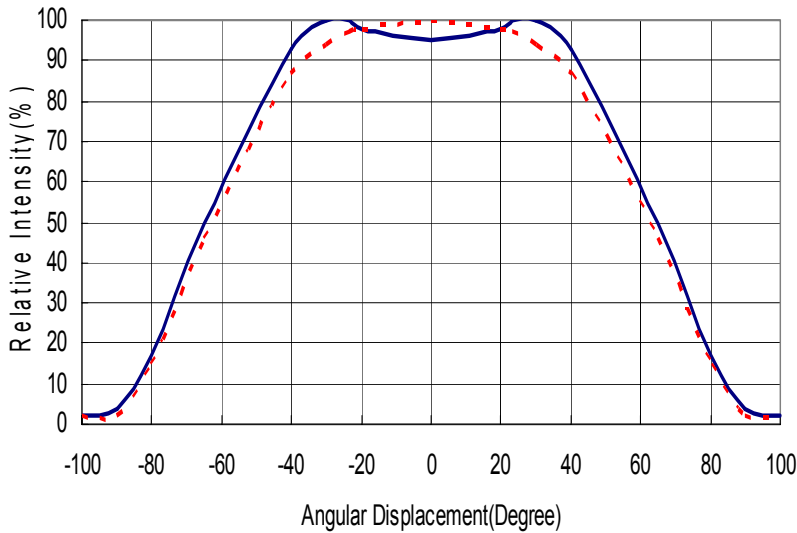

Fig. 1 Typical Radiation Pattern

Operating Current & Ambient Temperature

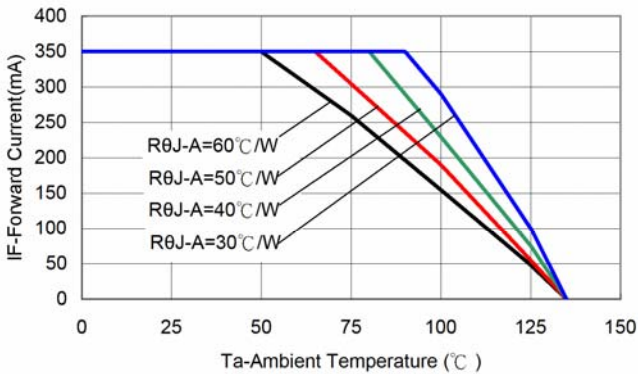

Fig 2a. Maximum Forward Current vs. Ambient Temperature. Derating based on $T_{JMAX}=135^{\circ}C$ for White, Warm White, Blue and Green.

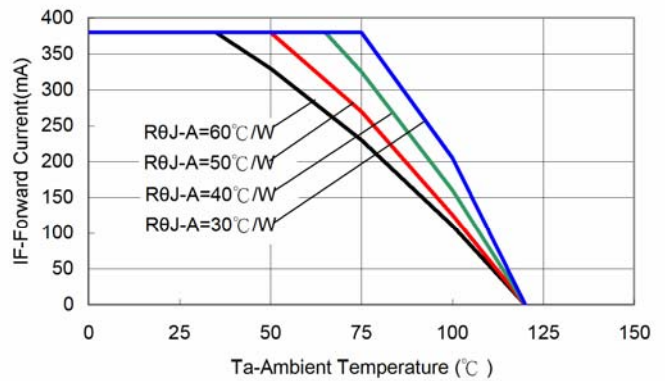

Fig 2b. Maximum Forward Current vs. Ambient Temperature. Derating based on $T_{JMAX}=120^{\circ}C$ for Amber, Red-Orange and Red.

Fig. 2 Forward Current vs Ambient Temperature

ProLite 1W SMD Emitter

BTP-99XXCG-XX-X/W

Forward Current Characteristics, $T_j=25^\circ\text{C}$

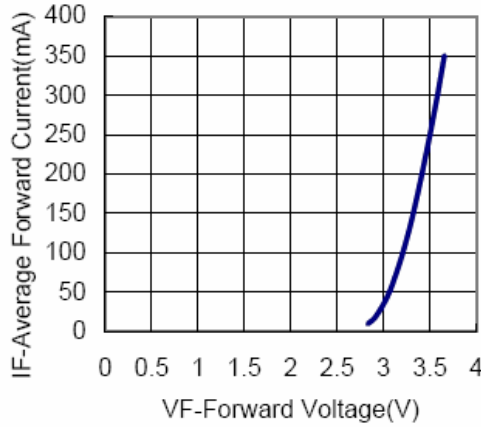

Fig 3a. Forward Current vs. Forward Voltage for White, Warm White, Blue and Green.

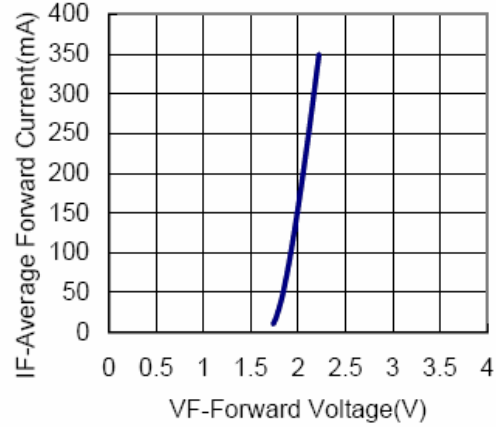

Fig 3b. Forward Current vs. Forward Voltage for Amber, Red-Orange and Red.

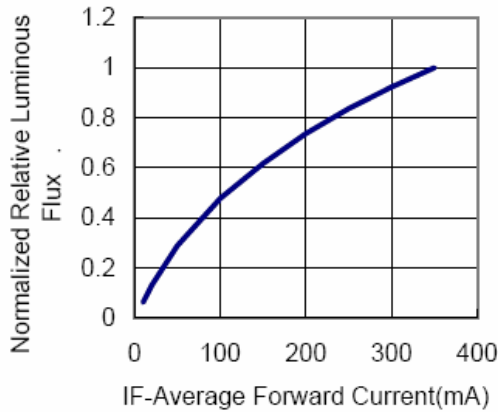

Fig 4a. Relative Luminous Flux vs. Forward Current for White, Warm White, Blue and Green at $T_j=25^\circ\text{C}$ maintained.

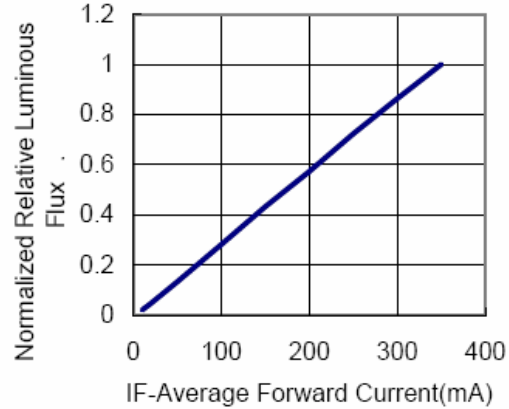

Fig 4b. Relative Luminous Flux vs. Forward Current for Amber, Red-Orange, Red at $T_j=25^\circ\text{C}$ maintained.

Light Output & Junction Temperature

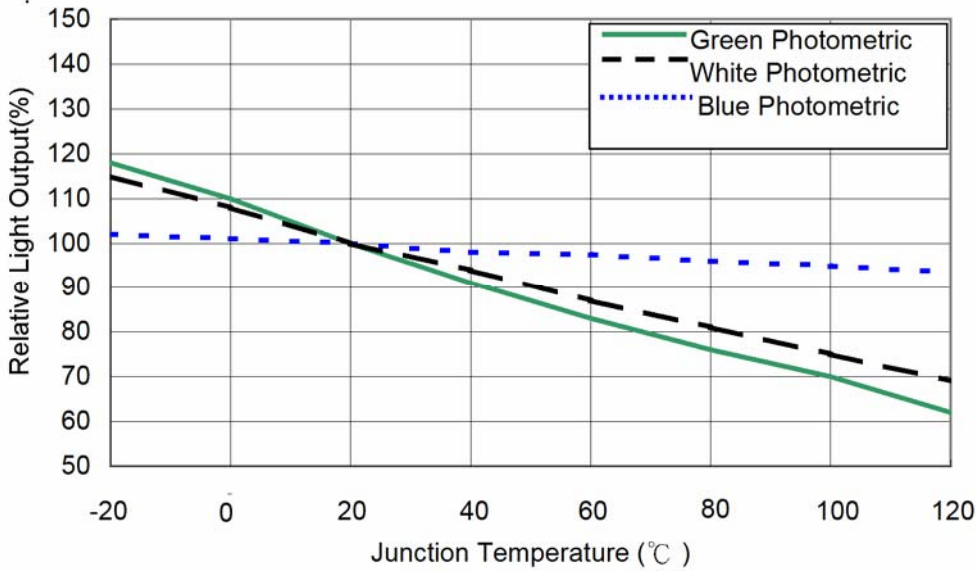

Fig. 5a Relative Light Output vs Junction Temperature

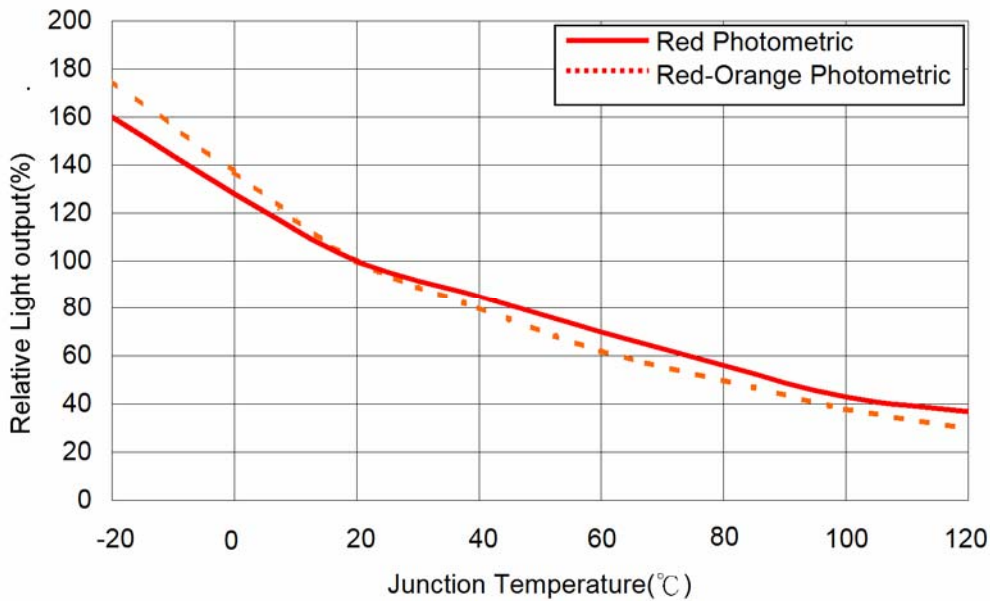

Fig. 5b Relative Light Output vs Junction Temperature

Wavelength Characteristics, $T_J = 25^\circ\text{C}$

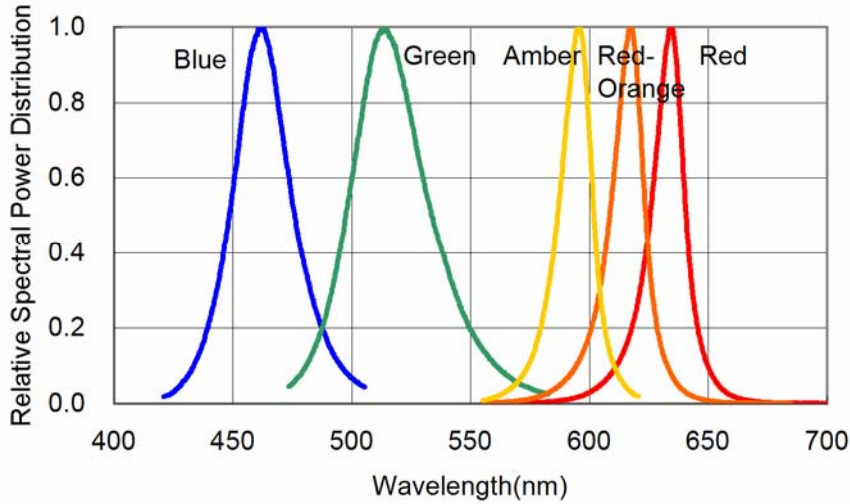

Fig. 6a Relative Intensity vs Wavelength

White Color Spectrum, $T_J = 25^\circ\text{C}$

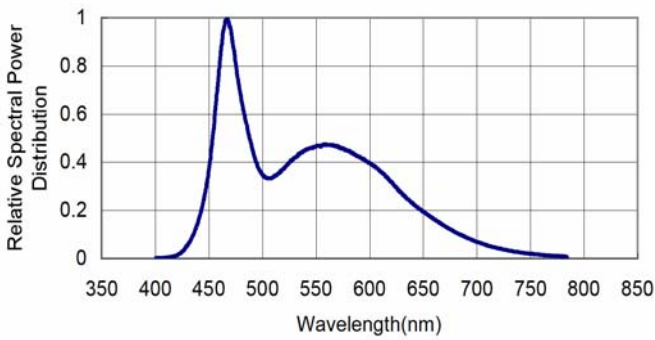

Fig. 6b White Color Spectrum (Typ 5500K)

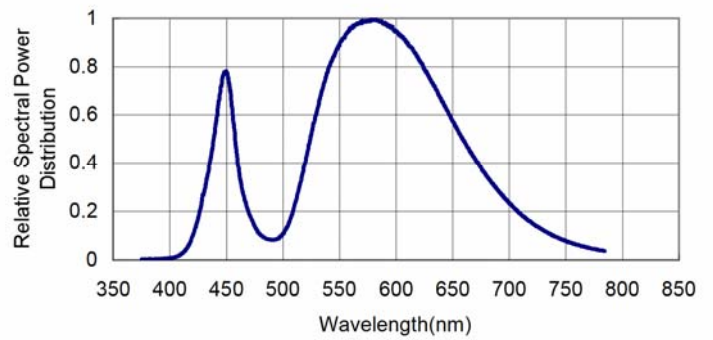
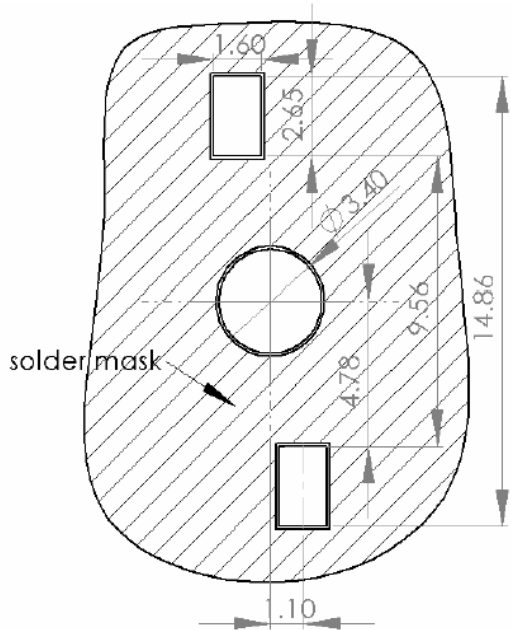

Fig. 6c Warm White Color Spectrum (Typ 3300K)

ProLite 1W SMD Emitter

BTP-99XXCG-XX-X/W

Recommended Solder Pad Layout



Tape and Reel Packaging Dimension

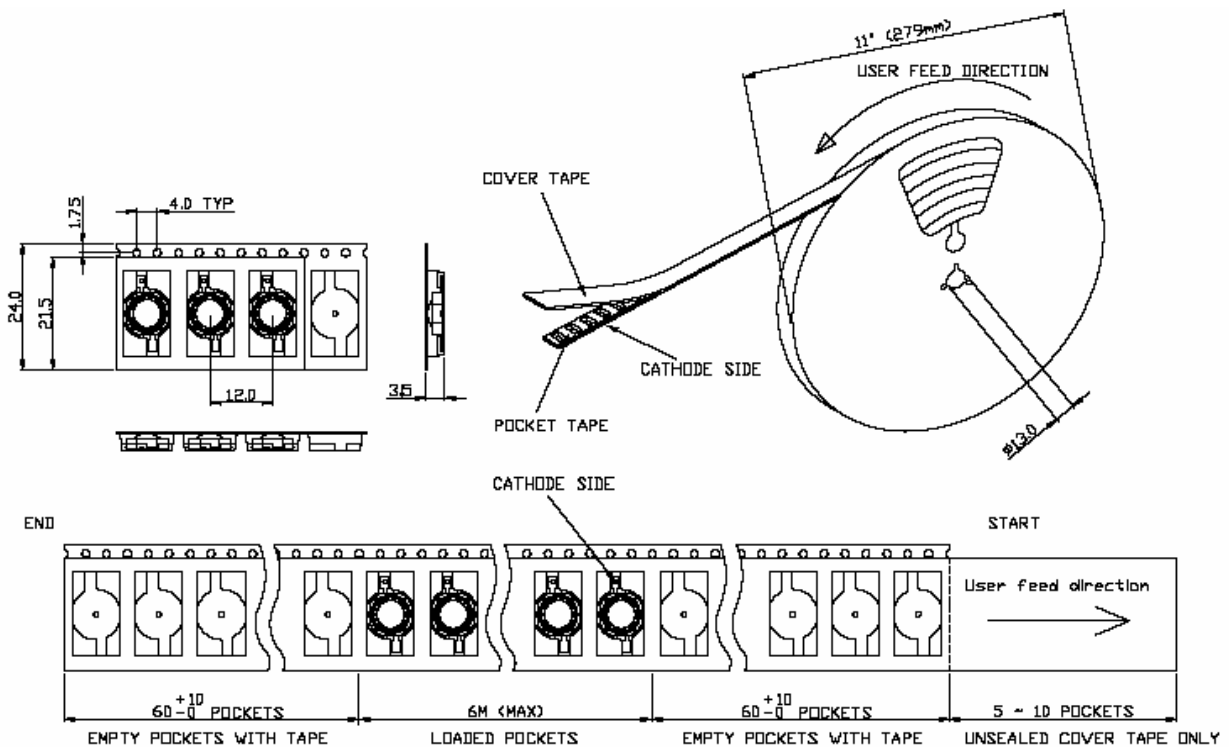

Note: The emitter should be picked up by the body (not lens) during placement. The inner diameter of the pick-up collect should be greater or equal to 6.5mm

Recommended IR Reflow Conditions

Reflow Soldering		
	Lead Solder	Lead-Free Solder
Pre-heat	120~150°C	180~200°C
Pre-heat time	120 sec Max	120 sec Max
Peak Temperature	240°C Max	260°C Max
Soldering Time	10 sec Max	10 sec Max
Conditions	Refer to Temperature profile A	Refer to Temperature profile B (N ₂ reflow is recommended)

Temperature Profile A (Surface of MCPCB)

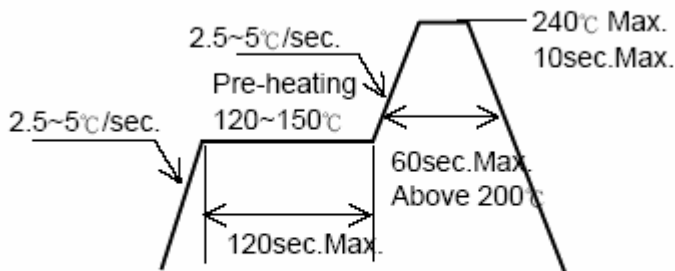

Figure 8a. Lead Solder Temperature Profile

Temperature Profile B (Surface of MCPCB)

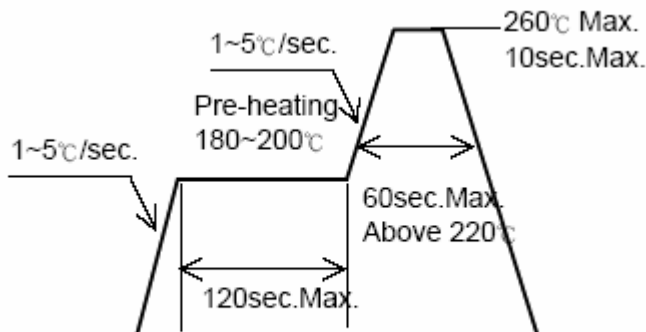

Figure 8b. Lead-free Solder Temperature Profile



ProLite 1W SMD Emitter

BTP-99XXCG-XX-X/W

IR Reflow Process Notes

- Occasionally there is a brightness decrease due to the influence of heat or ambient during air reflow. It is recommended that customer use nitrogen reflow method.
- Repairing should not be done after the LEDs have been soldered. When repairing is required, double-head soldering iron should be used. Customer should confirm whether the characteristics of the LEDs will or will not be damaged before carrying out the repair.
- Reflow soldering should not be done more than two times
- When soldering, do not put stress on the LEDs during heating.
- After soldering, do not warp the circuit board.

Manual Hand Soldering Notes

- For prototype builds or small production runs, it is possible to place and solder the emitters.
- It is recommended to hand solder the leads and slug with a solder tip temperature of 230°C for less than 10 seconds. This profile ensures a junction temperature below the maximum of 120°C, avoiding damage to the emitter or to the MCPCB dielectric layer. Damage dielectric layer can cause a short circuit in the array.

Other Important Notes:

- The information contained herein is presented only as a Guide for the application of our products. Brilliance Technologies assumes no responsibility for any infringement of intellectual property or other rights of the third parties which may result from its use.
- Brilliance Technologies continually improves the quality of our products. Nevertheless, semiconductor devices in general can malfunction or fail due to their inherent electrical sensitivity and vulnerability to physical stress. It is the responsibility of the customer, when using Brilliance Technologies products, to comply with the standard of safety in making a safe design for the entire system, and to avoid situations in which a malfunction or failure of such Brilliance Technologies products cause loss of human life, bodily injury or damage to property.
- Brilliance Technologies products listed in this data sheet are intended for usage in general electronics and/or non-commercial or industrial lighting products. These products are neither intended nor warranted for usage in equipment that requires extraordinarily high quality and/or reliability or a malfunction or failure of which may cause loss of human life or bodily injury.
- In developing your design, please ensure that Brilliance Technologies products are used within specified operating ranges as set forth in the most recent Brilliance Technologies data sheets.