

# DATA SHEET

## ARRAY CHIP RESISTORS

YC/TC  
5%, 1%

sizes

YC: 102/104/122/124/162/164/248/324/158T/358L/358T

TC: 122/124/164

RoHS compliant





**PHYCOMP BRAND ordering codes**

Both GLOBAL PART NUMBER (preferred) and I2NC (traditional) codes are acceptable to order Phycomp brand products.

**GLOBAL PART NUMBER (PREFERRED)**

For detailed information of GLOBAL PART NUMBER and ordering example, please refer to page 2. TC122 series is supplied and ordered by global part number only.

**I2NC CODE**

| TYPE/<br>2×0402 | 2350 | XXX XXXXX L |            |     |           | PAPER / PE TAPE ON REEL (units) <sup>(2)</sup> |  |
|-----------------|------|-------------|------------|-----|-----------|--|--|
|                 | (1)  | (2)         | (3)        | (4) | 10,000    | 50,000   |  |
| ARV321          | 2350 | ±5%         | 1 to 1 MΩ  |     | 013 11xxx | 013 12xxx                                      |  |
| ARV322          | 2350 | ±1%         | 10 to 1 MΩ |     | 013 2xxxx | 013 3xxxx                                      |  |
| Jumper          | 2350 | -           | 0 Ω        |     | 013 91001 | -  |  |

| Last digit of I2NC<br>Resistance decade <sup>(3)</sup> | Last digit |
|--|------------|
| 0.01 to 0.0976 Ω                                       | 0          |
| 0.1 to 0.976 Ω   | 7          |
| 1 to 9.76 Ω  | 8          |
| 10 to 97.6 Ω   | 9          |
| 100 to 976 Ω   | 1          |
| 1 to 9.76 KΩ   | 2          |
| 10 to 97.6 KΩ  | 3          |
| 100 to 976 KΩ  | 4          |
| 1 to 9.76 MΩ   | 5          |
| 10 to 97.6 MΩ  | 6          |

- (1) The resistors have a 12-digit ordering code starting with 2350.
- (2) The subsequent 4 or 5 digits indicate the resistor tolerance and packaging.
- (3) The remaining 4 or 3 digits represent the resistance value with the last digit indicating the multiplier as shown in the table of "Last digit of I2NC".
- (4) "L" is optional symbol <sup>(Note)</sup>.

Example:

|        |   |             |
|--------|---|-------------|
| 0.02 Ω | = | 0200 or 200 |
| 0.3 Ω  | = | 3007 or 307 |
| 1 Ω    | = | 1008 or 108 |
| 33 KΩ  | = | 3303 or 333 |
| 10 MΩ  | = | 1006 or 106 |

**ORDERING EXAMPLE**

The ordering code of a ARV321 resistor, value 1,000Ω with ±5% tolerance, supplied in tape of 10,000 units per reel is: 235001311102(L) or YC122-JR-071KL.

**NOTE**

- 1. All our RSMD products are RoHS compliant. "LFP" of the internal 2D reel label mentions "Lead Free Process"
- 2. On customized label, "LFP" or specific symbol printed and the optional "L" at the end of GLOBAL PART NUMBER / I2NC can be added (both are on customer request)

**MARKING**

**YCI02**

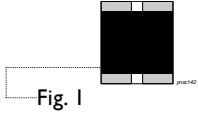

No marking

**YCI22**

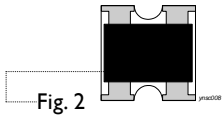

No marking

**YCI04**

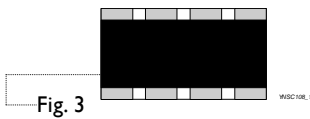

No marking

**YCI24 / 162 / 164 / 324**

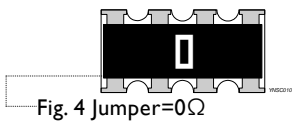

I-Digit marking

Fig. 4 Jumper=0Ω

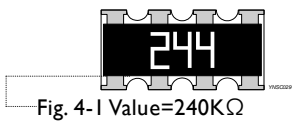

E-24 series: 3 digits, 5%  
First two digits for significant figure and 3rd digit for number of zeros

Fig. 4-I Value=240KΩ

**YC248**

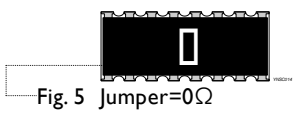

I-Digit marking

Fig. 5 Jumper=0Ω

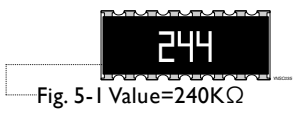

E-24 series: 3 digits, 5%  
First two digits for significant figure and 3rd digit for number of zeros

Fig. 5-I Value=240KΩ

**YCI58T/358L/358T**

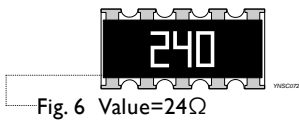

Fig. 6 Value=24Ω

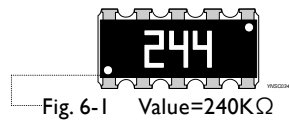
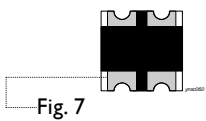

Fig. 6-I Value=240KΩ

E-24 series: 3 digits  
First two digits for significant figure and 3rd digit for number of zeros

**TCI22**



No marking

Fig. 7

**TCI24**

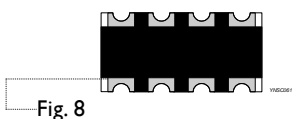

No marking

Fig. 8

TCI64



I-Digit marking

Fig. 9 Jumper=0Ω



E-24 series: 3 digits, 5%  
First two digits for significant figure and 3rd digit for number of zeros

Fig. 9-1 Value=240KΩ

For further marking information, please refer to data sheet “Chip resistors marking”.

**CONSTRUCTION**

The resistor is constructed on top of a high-grade ceramic body. Internal metal electrodes are added on each end to make the contacts to the thick film resistive element. The composition of the resistive element is a noble metal imbedded into a glass and covered by a second glass to prevent environment influences. The resistor is laser trimmed to the rated resistance value. The resistor is covered with a protective epoxy coat, finally the two external terminations (matte tin on Ni-barrier) are added as shown in Fig.9.

**OUTLINES**

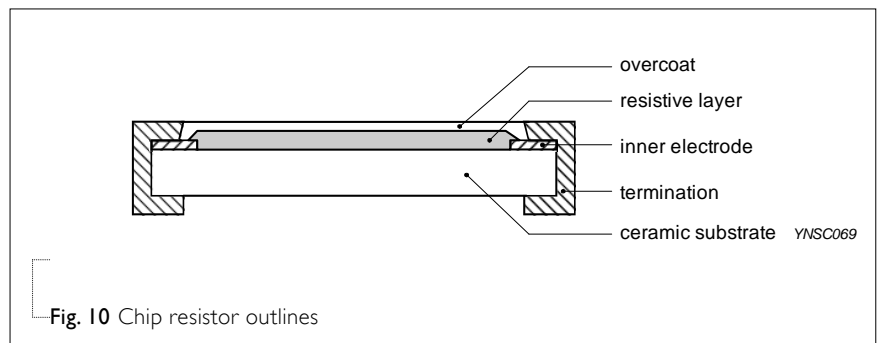
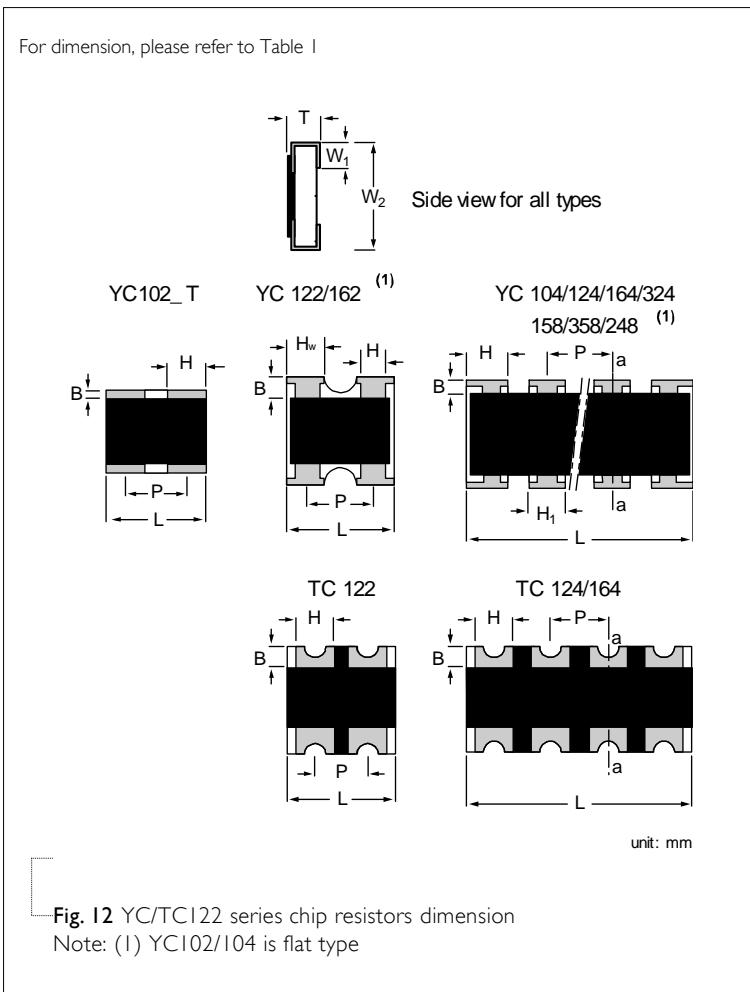
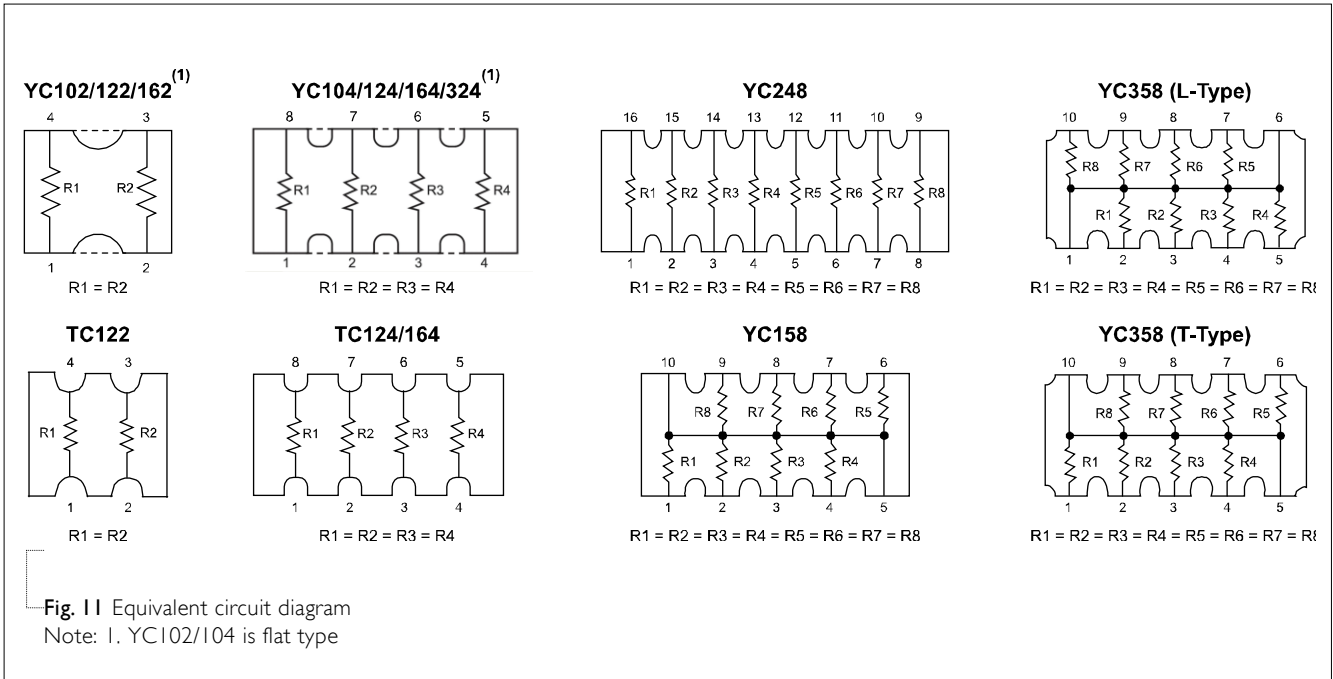

Fig. 10 Chip resistor outlines

**SCHEMATIC**



**DIMENSIONS**

Table I

| TYPE   | H / H <sub>I</sub> / H <sub>W</sub>                  | B           | P           | L           | T           | W1          | W2          |
|--------|--|-------------|-------------|-------------|-------------|-------------|-------------|
| YC102  | H: 0.25 ± 0.10                                       | 0.15 ± 0.10 | 0.55 ± 0.10 | 0.80 ± 0.10 | 0.35 ± 0.10 | 0.15 ± 0.10 | 0.60 ± 0.10 |
| YC104  | H: 0.20 ± 0.10                                       | 0.15 ± 0.05 | 0.40 ± 0.10 | 1.40 ± 0.10 | 0.35 ± 0.10 | 0.15 ± 0.10 | 0.60 ± 0.10 |
| YC122  | H: 0.21+0.10 / -0.05<br>H <sub>W</sub> : 0.35 ± 0.10 | 0.20 ± 0.10 | 0.67 ± 0.05 | 1.00 ± 0.10 | 0.30 ± 0.10 | 0.25 ± 0.10 | 1.00 ± 0.10 |
| YC124  | H: 0.40 ± 0.15<br>H <sub>I</sub> : 0.30 ± 0.05       | 0.20 ± 0.15 | 0.50 ± 0.05 | 2.00 ± 0.10 | 0.45 ± 0.10 | 0.30 ± 0.15 | 1.00 ± 0.10 |
| YC162  | H: 0.30 ± 0.10<br>H <sub>W</sub> : 0.65 ± 0.15       | 0.30 ± 0.10 | 0.80 ± 0.05 | 1.60 ± 0.10 | 0.40 ± 0.10 | 0.30 ± 0.10 | 1.60 ± 0.10 |
| YC164  | H: 0.65 ± 0.05<br>H <sub>I</sub> : 0.50 ± 0.15       | 0.30 ± 0.15 | 0.80 ± 0.05 | 3.20 ± 0.15 | 0.60 ± 0.10 | 0.30 ± 0.15 | 1.60 ± 0.15 |
| YC248  | H: 0.45 ± 0.05<br>H <sub>I</sub> : 0.30 ± 0.05       | 0.30 ± 0.15 | 0.50 ± 0.05 | 4.00 ± 0.20 | 0.45 ± 0.10 | 0.40 ± 0.15 | 1.60 ± 0.15 |
| YC324  | H: 1.10 ± 0.15<br>H <sub>I</sub> : 0.90 ± 0.15       | 0.50 ± 0.20 | 1.27 ± 0.05 | 5.08 ± 0.20 | 0.60 ± 0.10 | 0.50 ± 0.15 | 3.20 ± 0.20 |
| TC122  | H: 0.30 ± 0.05                                       | 0.25 ± 0.15 | 0.50 ± 0.05 | 1.00 ± 0.10 | 0.30 ± 0.10 | 0.25 ± 0.15 | 1.00 ± 0.10 |
| TC124  | H: 0.30 ± 0.10                                       | 0.20 ± 0.10 | 0.50 ± 0.05 | 2.00 ± 0.10 | 0.40 ± 0.10 | 0.25 ± 0.10 | 1.00 ± 0.10 |
| TC164  | H: 0.50 ± 0.15                                       | 0.30 ± 0.15 | 0.80 ± 0.05 | 3.20 ± 0.15 | 0.60 ± 0.10 | 0.30 ± 0.15 | 1.60 ± 0.15 |
| YC158T | H: 0.45 ± 0.05<br>H <sub>I</sub> : 0.32 ± 0.05       | 0.30 ± 0.15 | 0.64 ± 0.05 | 3.20 ± 0.20 | 0.60 ± 0.10 | 0.35 ± 0.15 | 1.60 ± 0.15 |
| YC358L | H: 1.10 ± 0.15                                       | 0.50 ± 0.15 | 1.27 ± 0.05 | 6.40 ± 0.20 | 0.60 ± 0.10 | 0.50 ± 0.15 | 3.20 ± 0.20 |
| YC358T | H <sub>I</sub> : 0.90 ± 0.15                         |             |             |             |             |             |             |

**ELECTRICAL CHARACTERISTICS**

Table 2

| TYPE             | POWER<br>P <sub>70</sub> | OPERATING<br>TEMP. RANGE | MWV   | RCOV | DWV  | RESISTANCE RANGE &<br>TOLERANCE                                      | T. C. R.  | Jumper criteria<br>(unit: A)           |
|------------------|--------------------------|--------------------------|-------|------|------|--|---|--|
| YC102            | 1/32W                    | -55°C to +125°C          | 15V   | 30V  | 30V  | E24 ±5% 10Ω ≤ R ≤ 1MΩ<br>E24/E96 ±1% 10Ω ≤ R ≤ 1MΩ<br>Jumper < 0.05Ω | ±200 ppm/°C   | Rated current 0.5<br>Max. current 1.0  |
| YC104            | 1/32W                    | -55°C to +125°C          | 12.5V | 25V  | 25V  | E24 ±5% 10Ω ≤ R ≤ 1MΩ<br>E24/E96 ±1% 10Ω ≤ R ≤ 1MΩ<br>Jumper < 0.05Ω |   | Rated current 0.5<br>Max. current 1.0  |
| YC122            | 1/16W                    | -55°C to +155°C          | 50V   | 100V | 100V | E24 ±5% 1Ω ≤ R ≤ 1MΩ<br>E24/E96 ±1% 1Ω ≤ R ≤ 1MΩ<br>Jumper < 0.05Ω   | 1Ω ≤ R ≤ 10Ω<br>±250 ppm/°C<br>10Ω ≤ R ≤ 1MΩ<br>±200 ppm/°C | Rated current 0.5<br>Max. current 1.0  |
| YC124            | 1/16W                    | -55°C to +155°C          | 25V   | 50V  | 100V | E24 ±5% 1Ω ≤ R ≤ 1MΩ<br>E24/E96 ±1% 1Ω ≤ R ≤ 1MΩ<br>Jumper < 0.05Ω   |   | Rated current 1.0<br>Max. current 2.0  |
| YC162            | 1/16W                    | -55°C to +155°C          | 50V   | 100V | 100V | E24 ±5% 1Ω ≤ R ≤ 1MΩ<br>E24/E96 ±1% 1Ω ≤ R ≤ 1MΩ<br>Jumper < 0.05Ω   |   | Rated current 1.0<br>Max. current 2.0  |
| YC164            | 1/16W                    | -55°C to +155°C          | 50V   | 100V | 100V | E24 ±5% 1Ω ≤ R ≤ 1MΩ<br>E24/E96 ±1% 1Ω ≤ R ≤ 1MΩ<br>Jumper < 0.05Ω   |   | Rated current 1.0<br>Max. current 2.0  |
| YC248            | 1/16W                    | -55°C to +155°C          | 50V   | 100V | 100V | E24 ±5% 10Ω ≤ R ≤ 1MΩ<br>E24/E96 ±1% 10Ω ≤ R ≤ 1MΩ<br>Jumper < 0.05Ω |   | Rated current 2.0<br>Max. current 10.0 |
| YC324            | 1/8W                     | -55°C to +155°C          | 200V  | 500V | 500V | E24 ±5% 10Ω ≤ R ≤ 1MΩ<br>E24/E96 ±1% 10Ω ≤ R ≤ 1MΩ                   |   | ---                                    |
| TC122            | 1/16W                    | -55°C to +125°C          | 50V   | 100V | 100V | E24 ±5% 10Ω ≤ R ≤ 1MΩ<br>E24/E96 ±1% 10Ω ≤ R ≤ 1MΩ<br>Jumper < 0.05Ω | ±200 ppm/°C   | Rated current 1.0<br>Max. current 1.5  |
| TC124            | 1/16W                    | -55°C to +125°C          | 50V   | 100V | 100V | E24 ±5% 10Ω ≤ R ≤ 1MΩ<br>E24/E96 ±1% 10Ω ≤ R ≤ 1MΩ<br>Jumper < 0.05Ω |   | Rated current 1.0<br>Max. current 1.5  |
| TC164            | 1/16W                    | -55°C to +155°C          | 50V   | 100V | 100V | E24 ±5% 10Ω ≤ R ≤ 1MΩ<br>E24/E96 ±1% 10Ω ≤ R ≤ 1MΩ<br>Jumper < 0.05Ω |   | Rated current 1.0<br>Max. current 2.0  |
| YC158T           | 1/16W                    | -55°C to +155°C          | 25V   | 50V  | 50V  | E24 ±5% 10Ω ≤ R ≤ 100KΩ  |   | ---                                    |
| YC358L<br>YC358T | 1/16W                    | -55°C to +155°C          | 50V   | 100V | 100V | E24 ±5% 10Ω ≤ R ≤ 330KΩ  |   | ---                                    |

**FOOTPRINT AND SOLDERING PROFILES**

For recommended footprint and soldering profiles, please refer to data sheet “Chip resistors mounting”.

**PACKING STYLE AND PACKAGING QUANTITY**

Table 3 Packing style and packaging quantity

| PACKING STYLE              | PACKING STYLE | YC102/<br>104 | YC/TC<br>122 | YC/TC<br>124 | YC162 | YC/TC<br>164 | YC248 | YC324 | YC158T | YC358L<br>YC358T |
|----------------------------|---------------|---------------|--------------|--------------|-------|--------------|-------|-------|--------|------------------|
| Paper taping reel ( R )    | 7" (178mm)    | 10,000        | 10,000       | 10,000       | 5,000 | 5,000        | 5,000 | ---   | 5,000  | ---              |
|                            | 13" (254mm)   | 50,000        | 50,000       | 40,000       | ---   | 20,000       | ---   | ---   | 20,000 | ---              |
| Embossed taping reel ( K ) | 7" (178mm)    | ---           | ---          | ---          | ---   | ---          | 4,000 | 4,000 | ---    | 4,000            |

**NOTE**

I. For tape and reel specification/dimensions, please refer to data sheet “Chip resistors packing”.



**FUNCTIONAL DESCRIPTION**

**OPERATING TEMPERATURE RANGE**

YC102/104, TC122/124 Range:

-55°C to +125°C (Fig.13)

YC122/124/162/164/248/324/158T/358L/358T, TC164

Range:

-55°C to +155°C(Fig.14)

**POWER RATING**

Each type rated power at 70°C

YC102/104 = 1/32 W

YC122/124/162/164/248/158T/358L/358T = 1/16 W

YC324 = 1/8 W

TC122/124/164 = 1/16 W

**RATED VOLTAGE**

The DC or AC (rms) continuous working voltage corresponding to the rated power is determined by the following formula:

$$V = \sqrt{P \times R}$$

or max. working voltage whichever is less

Where

V=Continuous rated DC or AC (rms) working voltage (V)

P=Rated power (W)

R=Resistance value (Ω)

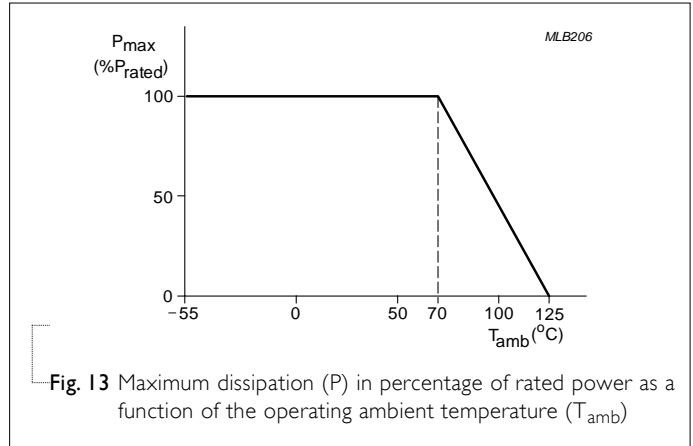

**TESTS AND REQUIREMENTS**
**Table 4** Test condition, procedure and requirements

| TEST   | TEST METHOD            | PROCEDURE   | REQUIREMENTS                           |
|--|------------------------|---|--|
| Life/<br>Operational Life/<br>Endurance  | MIL-STD-202-method 108 | 1,000 hours at 70±5 °C applied RCWV   | ±(2%+0.05 Ω)                           |
|  | IEC 60115-1 4.25.1     | 1.5 hours on, 0.5 hour off, still air required  | <100 mΩ for Jumper                     |
|  | JIS C 5202-7.10        |   |  |
| High Temperature<br>Exposure/<br>Endurance at<br>Upper Category<br>Temperature | MIL-STD-202-method 108 | 1,000 hours at maximum operating  | ±(1%+0.05 Ω)                           |
|  | IEC 60115-1 4.25.3     | temperature depending on specification,<br>unpowered  | <50 mΩ for Jumper                      |
|  | JIS C 5202-7.11        | No direct impingement of forced air to the<br>parts<br>Tolerances: 125±3 °C   |  |
| Moisture<br>Resistance   | MIL-STD-202-method 106 | Each temperature / humidity cycle is defined at   | ±(2%+0.05 Ω)                           |
|  | IEC 60115-1 4.24.2     | 8 hours (method 106F), 3 cycles / 24 hours for<br>10d with 25 °C / 65 °C 95% R.H, without<br>steps 7a & 7b, unpowered | <100 mΩ for Jumper                     |
|  |                        | Parts mounted on test-boards, without<br>condensation on parts<br>Measurement at 24±2 hours after<br>test conclusion  |  |
| Thermal Shock  | MIL-STD-202-method 107 | -55/+125 °C   | ±(1%+0.05 Ω)                           |
|  |                        | Note: Number of cycles required is 300.<br>Devices mounted  | <50 mΩ for Jumper                      |
|  |                        | Maximum transfer time is 20 seconds. Dwell<br>time is 15 minutes. Air – Air   |  |
| Short Time<br>Overload   | MIL-R-55342-para 4.7.5 | 2.5 times RCWV or maximum overload  | ±(2%+0.05 Ω)                           |
|  | IEC60115-1 4.13        | voltage whichever is less for 5 sec at room<br>temperature  | <50 mΩ for Jumper<br>No visible damage |
| Board Flex/<br>Bending   | IEC60115-1 4.33        | Device mounted on PCB test board as<br>described, only 1 board bending required                                       | ±(1%+0.05 Ω)                           |
|  |                        | 3 mm bending  | <50 mΩ for Jumper                      |
|  |                        | Bending time: 60±5 seconds<br>Ohmic value checked during bending  | No visible damage                      |

| TEST                              | TEST METHOD            | PROCEDURE  | REQUIREMENTS   |
|-----------------------------------|------------------------|--|--|
| Solderability<br>- Wetting        | J-STD-002 test         | Electrical Test not required<br>Magnification 50X<br>SMD conditions:<br>1 <sup>st</sup> step: method B, aging 4 hours at 155 °C<br>dry heat<br>2 <sup>nd</sup> step: leadfree solder bath at 245±3 °C<br>Dipping time: 3±0.5 seconds | Well tinned (≥95% covered)<br>No visible damage        |
|                                   | - Leaching             | J-STD-002 test   | Leadfree solder, 260 °C, 30 seconds<br>immersion time  |
| - Resistance to<br>Soldering Heat | MIL-STD-202-method 210 | Condition B, no pre-heat of samples<br>Leadfree solder, 260 °C, 10 seconds<br>immersion time<br>Procedure 2 for SMD: devices fluxed and<br>cleaned with isopropanol  | ±(1%+0.05 Ω)<br><50 mΩ for Jumper<br>No visible damage |
| Biased Humidity                   | AEC-Q200 Test 7        | 1,000 hours; 85 °C / 85% RH  | ± (5.0%+0.05 Ω)  |
|                                   | MIL-STD-202-Method 103 | 10% of operating power<br>Measurement at 24± 4 hours after test<br>conclusion.   |  |

**REVISION HISTORY**

| REVISION  | DATE          | CHANGE NOTIFICATION | DESCRIPTION  |
|-----------|---------------|---------------------|--|
| Version 9 | Feb.19, 2019  | -                   | - Update H dimension for YC124                                   |
| Version 8 | Dec. 24, 2018 | -                   | - Update AEC-Q200 qualified                                      |
| Version 7 | Aug. 22, 2017 | -                   | - Correct the typo for YC158T/358L/358T, Marking, "240" is 24ohm |
| Version 6 | Jun. 1, 2017  | -                   | - Update ordering information for networks YC158T/YC358L/YC358T  |
| Version 5 | Feb. 14, 2017 | -                   | - Update YC158 and 358 part number to YC158T , YC358L and YC358T |
| Version 4 | Dec. 22, 2016 | -                   | - Delete YC102 default code L type                               |
| Version 3 | Apr. 29, 2016 | -                   | - Update YC series and TC164 dimension                           |
| Version 2 | Dec. 11, 2015 | -                   | - Update Operating Temperature                                   |
| Version 1 | Feb. 04, 2015 | -                   | - Update YC102 to flat type                                      |
| Version 0 | Nov. 14, 2014 | -                   | - First issue of this specification                              |

*“ Yageo reserves all the rights for revising the content of this datasheet without further notification, as long as the products itself are unchanged. Any product change will be announced by PCN.”*