

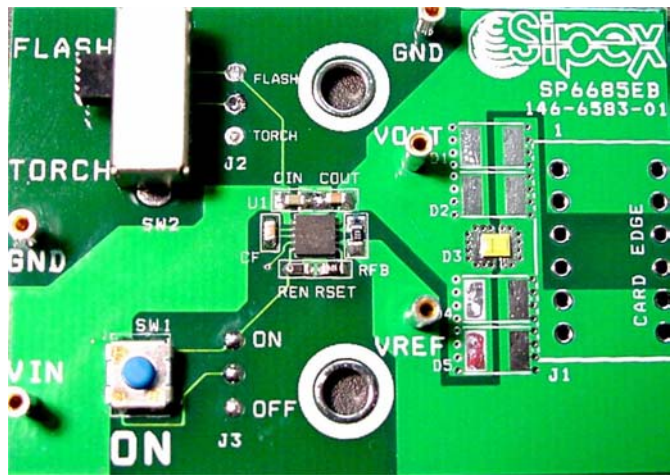

# SP6686EB Evaluation Board Manual

- 2.7V to 5.5V Input Range
- Typical 150mA Torch or 400mA Flash Output Current
- High Efficiency in 1X mode, high  $V_{OUT}$  in 2X mode
- Small 3x3mm 10-Pin DFN Package
- 2.4MHz Switching Frequency Enables Small Components
- Integrated Design with Minimal Components.
- Use with 1 cell Lithium Ion Battery



## DESCRIPTION AND BOARD SCHEMATIC

The **SP6686EB Evaluation Board** is a compact circuit including the SP6686 in 3x3mm DFN and 3 small 0603 capacitors which can provide a stable drive current for a 1W LED such as the AOT White LED, Lumi-LEDs Luxeon I or PWF1 type light sources. The evaluation board is a completely assembled and tested surface mount board which provides easy probe access points to all SP6686 inputs and outputs so that the user can quickly connect and measure electrical characteristics and waveforms.

### SP6686EB Schematic

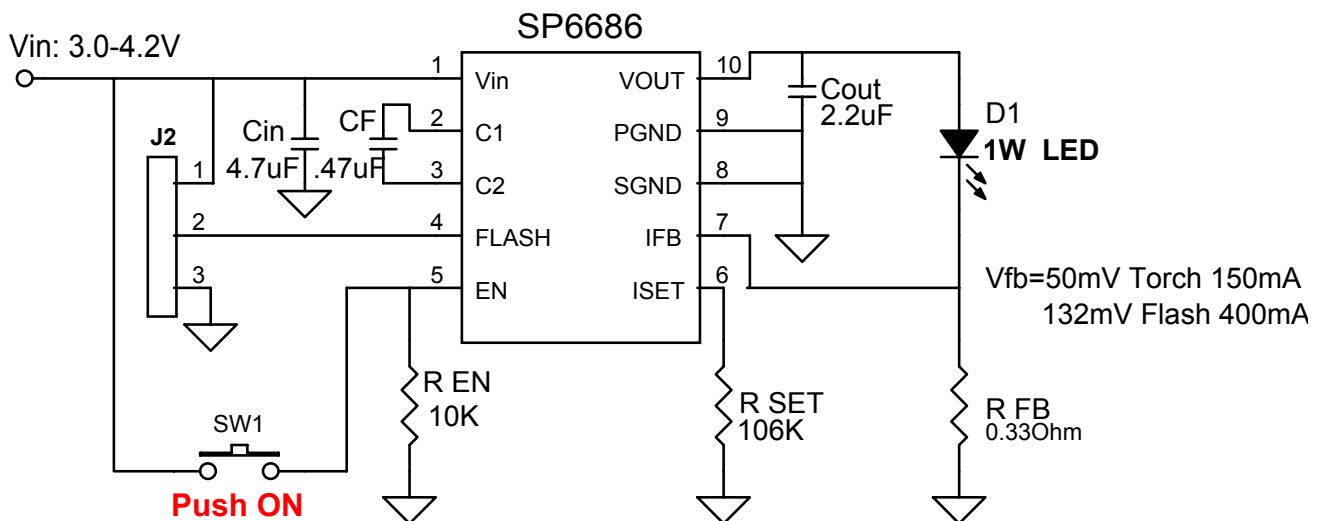

### TO GET STARTED:

1. Connect VIN from VIN to GND (VIN range 2.7V to 4.2V).
2. Select mode between TORCH and FLASH by putting jumper into corresponding position.
3. Apply High to ON terminal to turn the LED on.

# POWER SUPPLY DATA

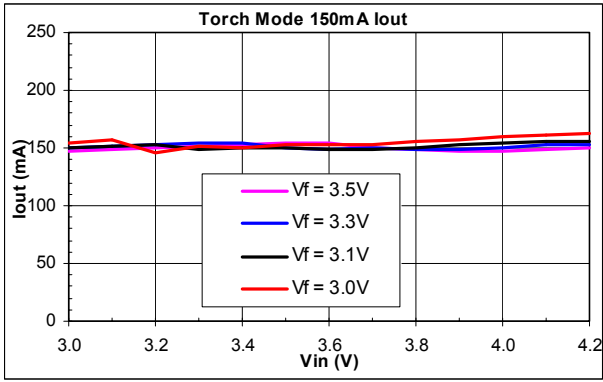

Figure 1. Torch Mode Output Current

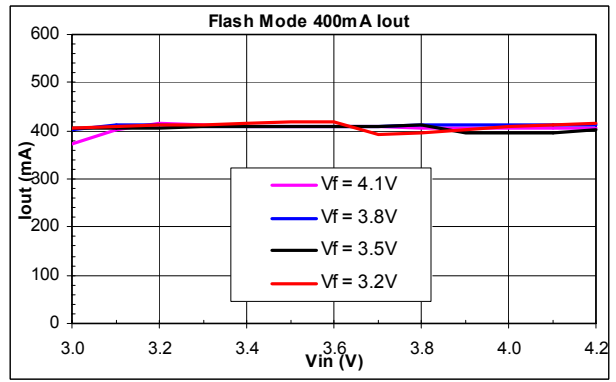

Figure 2. Flash Mode Output Current

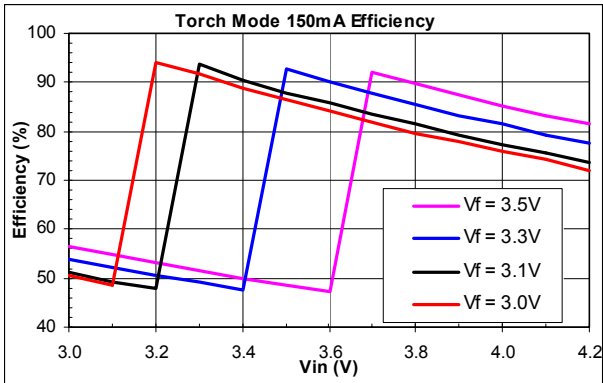

Figure 3. Torch Mode Efficiency

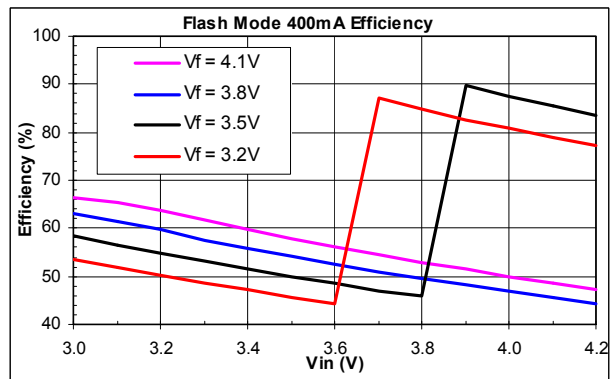

Figure 4. Flash Mode Efficiency

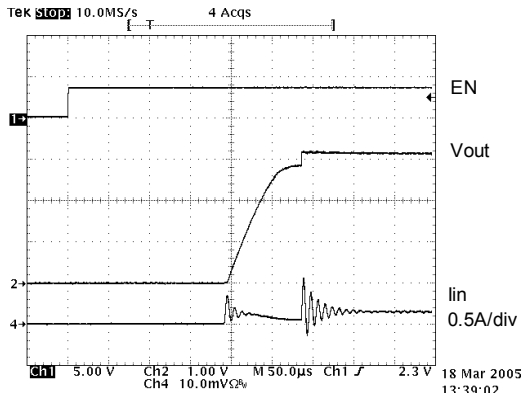

Figure 5. Startup 150mA Torch,  $V_{in}=3.6V$ ,  $V_{out}=3.1V$ .

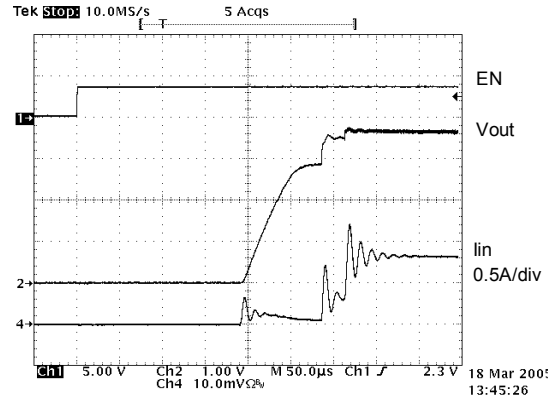

Figure 6. Startup 400mA Flash,  $V_{in}=3.6V$ ,  $V_{out}=3.5V$ .

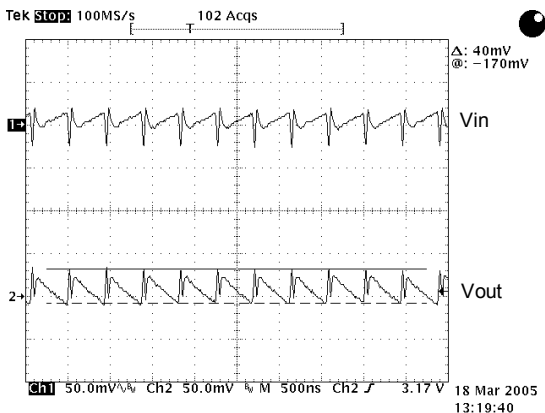

Figure 7. Ripple 150mA Torch,  $V_{in}=4.2V$ ,  $V_{out}=3.1V$ .  $C_{in}=4.7\mu F$ ,  $C_{FC}=0.47\mu F$ ,  $C_{out}=2.2\mu F$ .

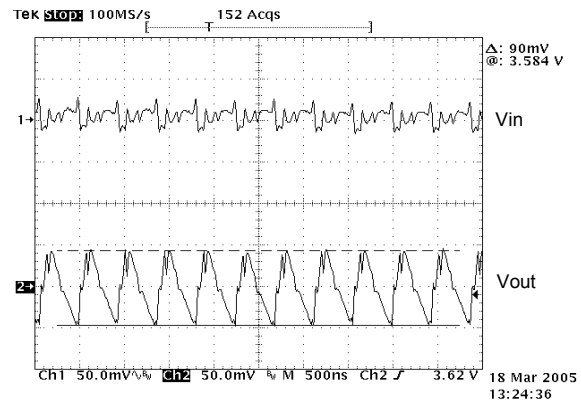

Figure 8. Ripple 400mA Flash,  $V_{in}=3.6V$ ,  $V_{out}=3.5V$ .  $C_{in}=4.7\mu F$ ,  $C_{FC}=0.47\mu F$ ,  $C_{out}=2.2\mu F$ .

# EVALUATION BOARD LAYOUT

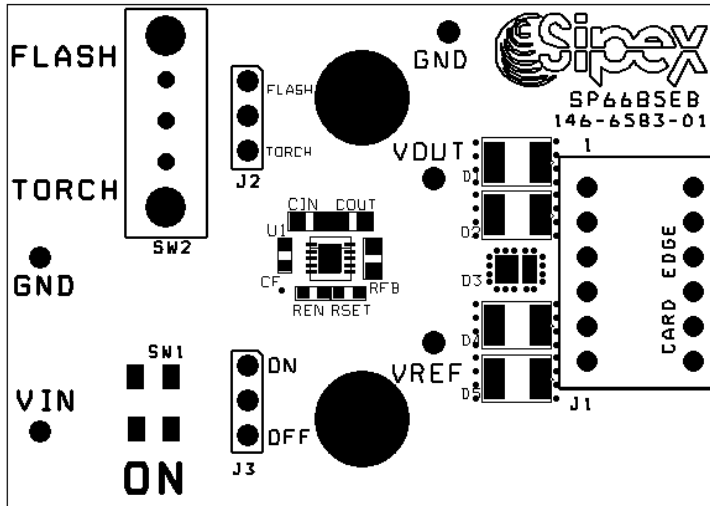

FIGURE 9: SP6686EB COMPONENT PLACEMENT

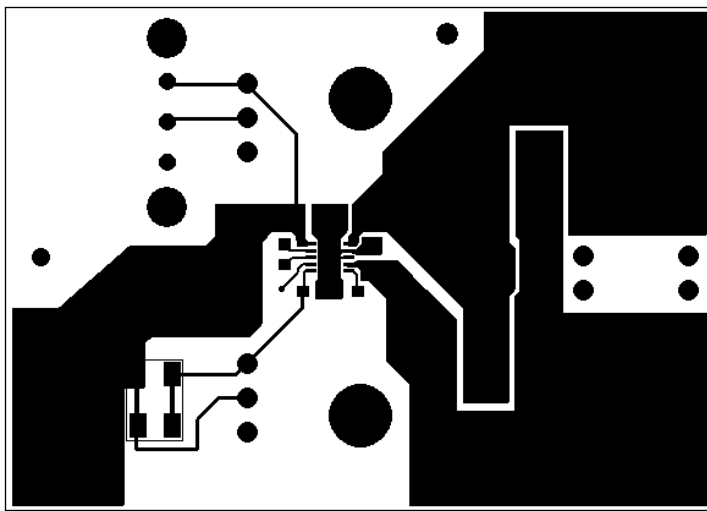

FIGURE 10: SP6686EB PC LAYOUT TOP SIDE

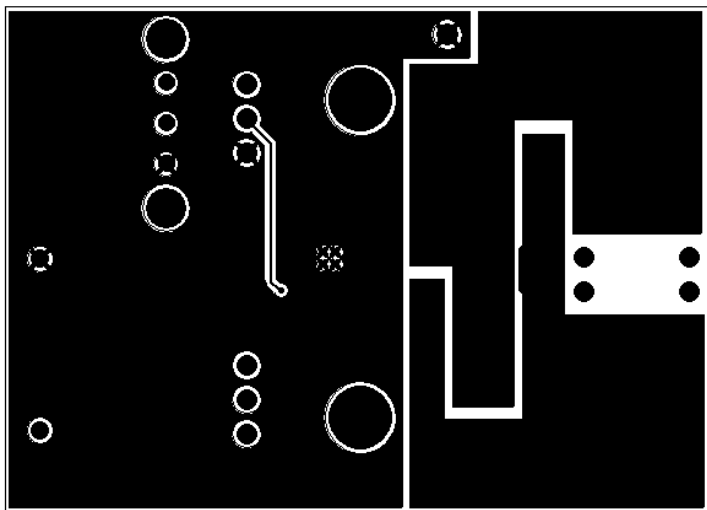

FIGURE 11: SP6686EB PC LAYOUT BOTTOM SIDE

**TABLE1: SP6686EB LIST OF MATERIALS**

Part Reference	Part Number	Value	Size	Manufacturers/ Website
U1	SP6686ER		3x3mm DFN - 10 pin	Sipex/www.sipex.cpm
CIN	GRM188R60J475KE19D	4.7uF/6.3V	0603/X5R/0.9mm ht	Murata/www.murata.com
CF	GRM155R60J105KE19B	0.47uF/6.3V	0402/X5R/0.5mm ht	Murata/www.murata.com
COUT	GRM188R60J225KE19D	2.2uF/6.3V	0603/X5R/0.9mm ht	Murata/www.murata.com
RSET	-	106K	0402	Rohm www.rohm.com
				Cyntec www.cyntec.com
RSENSE	-	0.33ohms	0603	Cyntec www.cyntec.com

**ORDERING INFORMATION**

Model	Temperature Range	Package Type
SP6686EB.....	-40°C to +85°C.....	SP6686EB Evaluation Board
SP6686ER.....	-40°C to +85°C.....	10-pin 3x3 DFN