

Logic Diagram

FEATURES:

- RAD-PAK® technology-hardened against natural space radiation
- Total dose hardness:
 - > 100 krad (Si), depending upon space mission
- Excellent Single Event Effects:
 - SELTH LET = > 90 MeV/mg/cm²
- Package: -14 pin Rad-Pak® flat pack
- Internally frequency compensated for unity gain
- Large DC voltage gain
- Wide bandwidth (unity gain): 1 MHz
- Large output voltage swing 0V to V₊ -1.5V
- Input common - mode voltage range includes ground
- Wide power supply range:
 - Single supply 3V to 32V
 - Dual supply ±1.5V to ±16V
- Very low current drain (essentially independent of supply voltage): 700 μ A
- Low input biasing current: 45 nA
- Low input offset voltage and current: 2mV, 5nA
- Differential input voltage range equal to the power supply voltage

DESCRIPTION:

Maxwell Technologies's 124 independent, high gain, internally frequency compensated operational amplifiers feature a greater than 100 krad (Si) total dose tolerance, depending upon space mission. Using Maxwell's radiation-hardened Rad-Pak® packaging technology, the 124 is designed specifically to operate from a single power supply over a wide range of voltages. The 124 also features operation from split power supplies, and the low power supply current drain is independent of the magnitude of the power supply voltage.

Maxwell Technologies' patented RAD-PAK® packaging technology incorporates radiation shielding in the microcircuit package. It eliminates the need for box shielding while providing the required radiation shielding for a lifetime in orbit or space mission. In a GEO orbit, RAD-PAK provides greater than 100 krad (Si) radiation dose tolerance. This product is available with screening up to Class S.

TABLE 1. PINOUT DESCRIPTION

PIN	SYMBOL	DESCRIPTION
1, 7, 8, 14	OUTPUT 1 - 4	Ouput
2, 6, 9, 13	INPUT 1- - 4-	Input (-)
3, 5, 10, 12	INPUT 1+ - 4+	Input (+)
4	V+	Power Supply
11	GND	Ground

TABLE 2. 124 ABSOLUTE MAXIMUM RATINGS

PARAMETER	SYMBOL	MIN	MAX	UNIT
Supply Voltage	V+		32	V
Differential Input Voltage			32	V
Input Voltage		-0.3	+32	V
Input Current ($V_{IN} < -0.3V$) ¹			50	mA
Output Short-Circuit to GND (One Amplifier) $V_+ \leq 15V, T_A = 25^\circ C^2$				Continuous
Storage Temperature Range	T_S	-65	150	°C
Operating Temperature Range	T_A	-55	125	°C
ESD Tolerance ³			250	V

1. This input current will only exist when the voltage at any of the input leads is driven negative. It is due to the collector-base junction of the input PNP transistors becoming forward biased and thereby acting as input diode clamps. In addition to this diode action, there is also lateral NPN parasitic transistor action on the IC chip. This transistor action can cause the output voltages of the op amps to go to the V+ voltage level (or to ground for a large overdrive) for the time duration that an input is driven negative. This is not destructive and normal output states will re-establish when the input voltage, which was negative, again returns to a value greater than -0.3V (at 25°C).
2. Short circuits from the output to V+ can cause excessive heating and eventual destruction. When considering short circuits to ground, the maximum output current is approximately 40 mA independent of the magnitude of V+. At values of supply voltage in excess of +15V, continuous short-circuits can exceed the power dissipation ratings and cause eventual destruction. Destructive dissipation can result from simultaneous shorts on all amplifiers.
3. Human body model, 1.5 kΩ in series with 100 pF.

TABLE 3. DELTA LIMITS

PARAMETER	VARIATION
I_{CC}	±10% of specified value in Table 4

TABLE 4. 124 ELECTRICAL CHARACTERISTICS
($V_+ = 5.0V$, $T_A = -55$ TO $+125^\circ C$, UNLESS OTHERWISE SPECIFIED)

PARAMETER	SYMBOL	TEST CONDITIONS	SUBGROUPS	MIN	TYP	MAX	UNITS
Supply Current	I_{CC}	Over Full Temperature Range RL = ∞ On All Op Amps V+ = 30V V+ = 5V	1, 2, 3		1.5 0.7	3 1.2	mA
Common-Mode Rejection Ratio	CMRR	DC, $V_{CM} = 0V$ to $V_+ - 1.5V$, $T_A = 25^\circ C$	1	70	85		dB
Power Supply Rejection Ratio	PSRR	V+ = 5V to 30V $T_A = 25^\circ C$	1	65	100		dB
Amplifier-to-Amplifier Coupling ¹		f = 1 kHz to 20 kHz, $T_A = 25^\circ C$ (Input Referred)	1		-120		dB
Short Circuit to Ground ²	I_{OS}	V+ = 15V, $T_A = 25^\circ C$	1		40		mA
Input Offset Voltage ³	V_{IO}		1, 2, 3			7	mV
Input Offset Voltage Drift		$R_S = 0\Omega$	1, 2, 3		7		$\mu V/^\circ C$
Input Offset Current	I_{OS}	$I_{IN(+)} - I_{IN(-)}$, $V_{CM} = 0V$	1, 2, 3	---	--	100	nA
Input Offset Current Drift		$R_S = 0\Omega$	1, 2, 3	---	10	--	$pA/^\circ C$
Input Bias Current	lib	$I_{IN(+)}$ or $I_{IN(-)}$	1, 2, 3	---	40	300	nA
Input Common-Mode Voltage Range ⁴		V+ = +30V	1, 2, 3	0		V+ -2	V
Large Signal Voltage Gain	A_{VS}	V+ = +15V (V_O Swing = 1V to 11V) RL > 2 k Ω	1, 2, 3	25			V/mV
Output Voltage Swing	V_{OH}	V+ = 30V, $R_L = 2\text{ k}\Omega$ $R_L = 10\text{ k}\Omega$	1, 2, 3	26 27	28		V
	V_{OL}	V+ = 5V, $R_L = 10\text{ k}\Omega$	1, 2, 3		5	20	mV
Output Current	Source	VO = 2V, $V_{IN+} = +1V$ $V_{IN-} = 0V$ V+ = 15V	1, 2, 3		20		mA
	Sink	$V_{IN+} = +1V$ $V_{IN-} = 0V$ V+ = 15V	1, 2, 3		15		

1. Due to proximity of external components, insure that coupling is not originating via stray capacitance between these external parts. This typically can be detected as this type of capacitance increases at higher frequencies.
2. Short circuits from the output to V+ can cause excessive heating and eventual destruction. When considering short circuits to ground, the maximum output current is approximately 40 mA independent of the magnitude of V+. At values of supply voltage in excess of +15V, continuous short-circuits can exceed the power dissipation ratings and cause eventual destruction. Destructive dissipation can result from simultaneous shorts on all amplifiers.
3. VO@1.4V, RS=0 Ω with V+ from 5V to 30V; and over the full input common-mode range (0V to V+ -1.5V).
4. The input common-mode voltage of either input signal voltage should not be allowed to go negative by more than 0.3V (at 25 $^\circ C$). The upper end of the common-mode voltage range is V+ -1.5V (at 25 $^\circ C$), but either or both inputs can go to +32V without damage independent of the magnitude of V+.

FIGURE 1. INPUT VOLTAGE RANGE

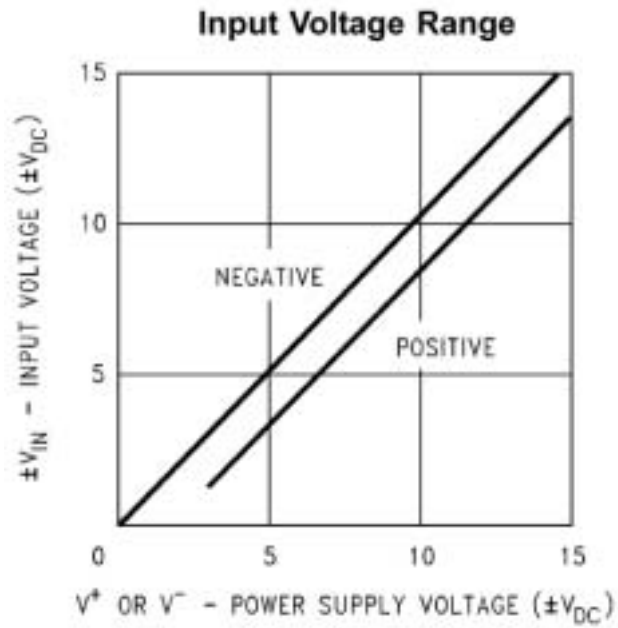

FIGURE 2. INPUT CURRENT

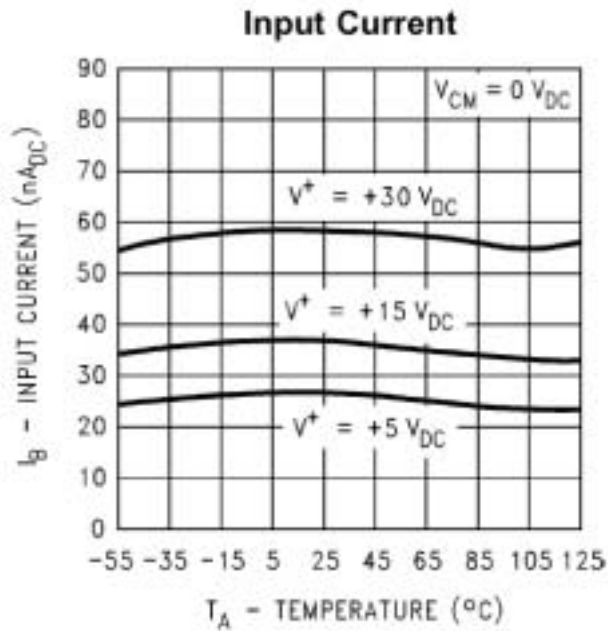

FIGURE 3. SUPPLY CURRENT

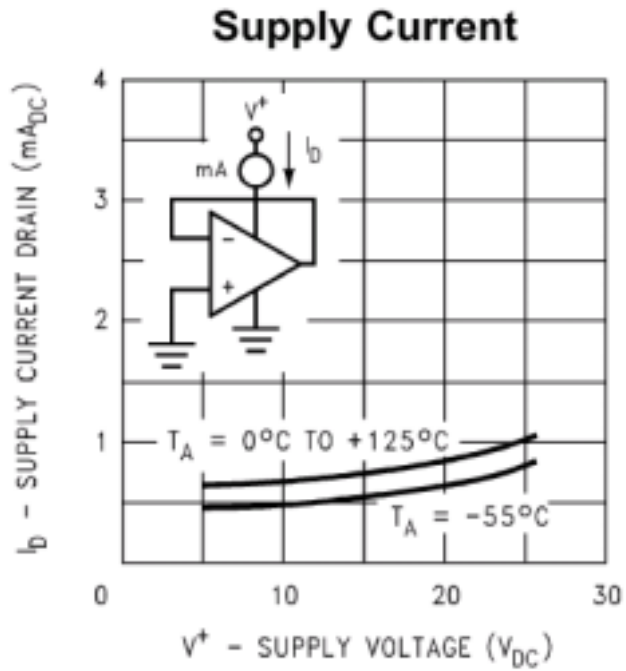

FIGURE 4. VOLTAGE GAIN

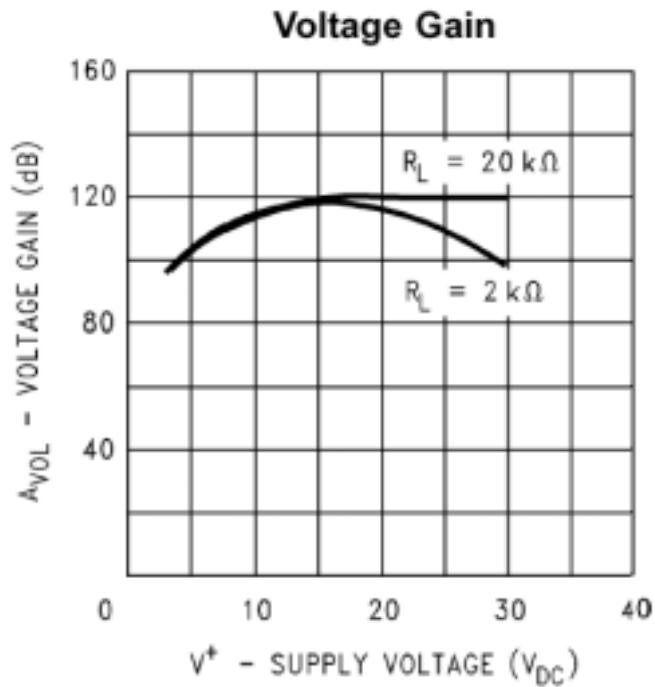

FIGURE 5. OPEN LOOP FREQUENCY RESPONSE

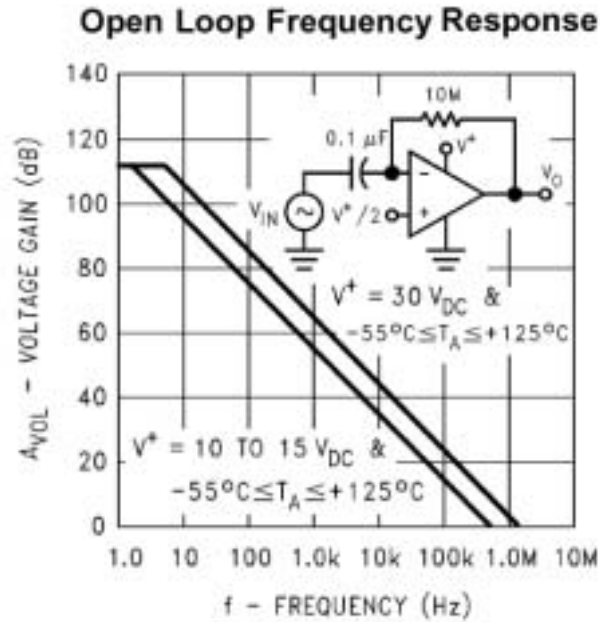

FIGURE 6. COMMON MODE REJECTION RATIO

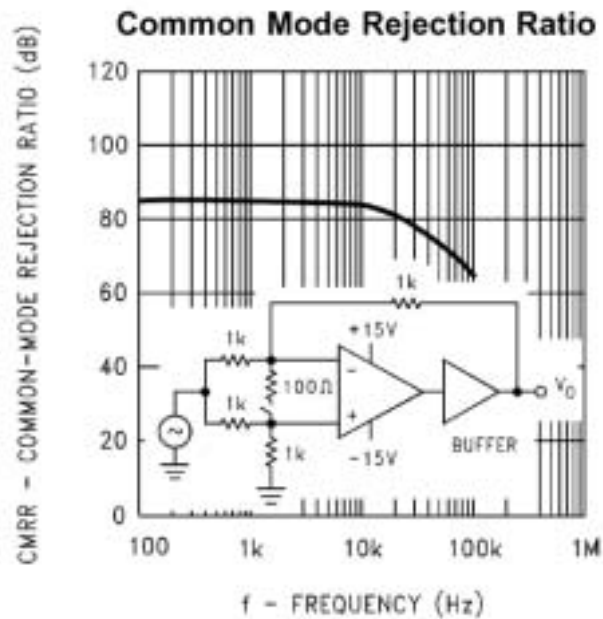

FIGURE 7. VOLTAGE FOLLOWER PULSE RESPONSE

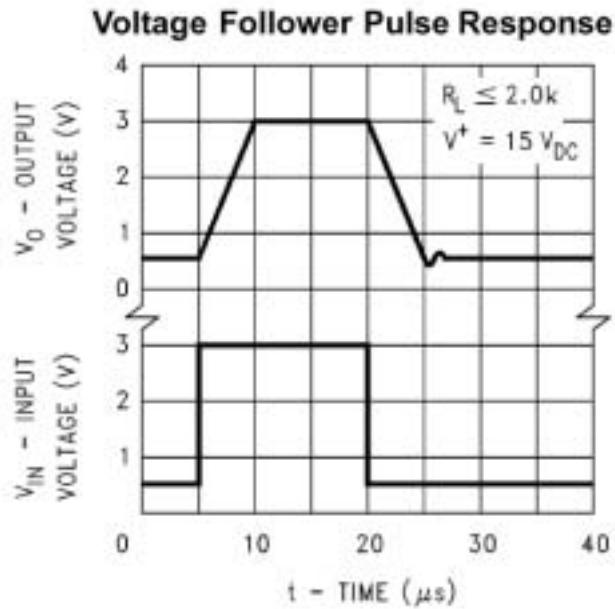

FIGURE 8. VOLTAGE FOLLOWER PULSE RESPONSE (SMALL SIGNAL)

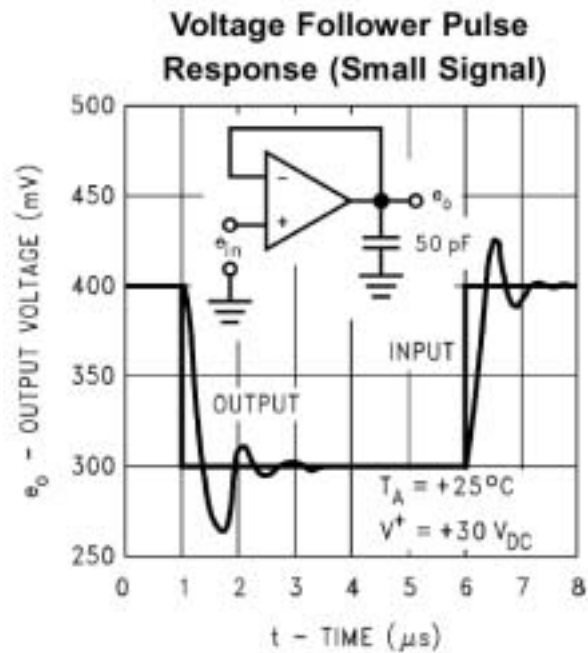

FIGURE 9. LARGE SIGNAL FREQUENCY RESPONSE

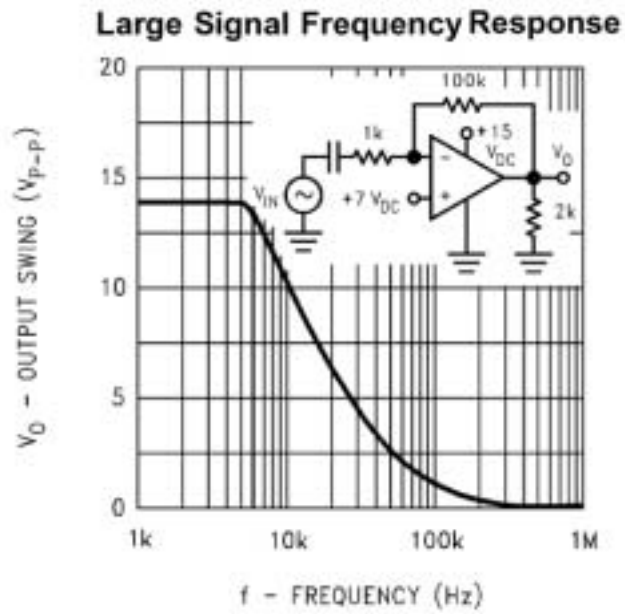

FIGURE 10. OUTPUT CHARACTERISTICS CURRENT SOURCING

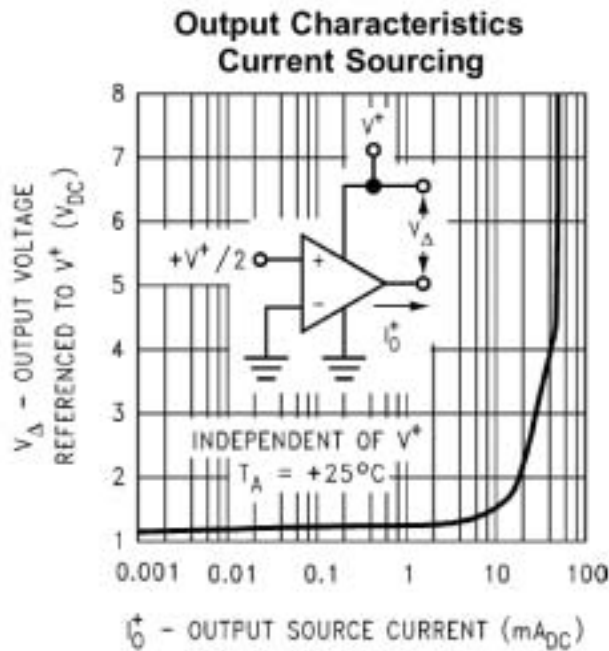

FIGURE 11. OUTPUT CHARACTERISTICS CURRENT SINKING

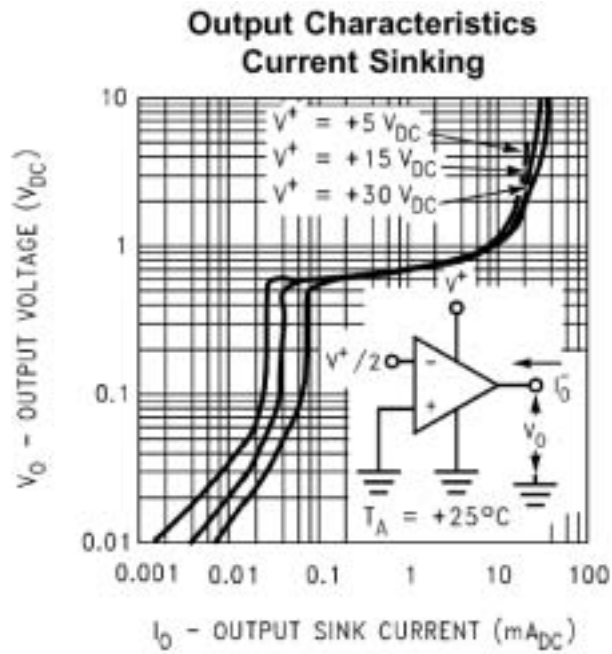
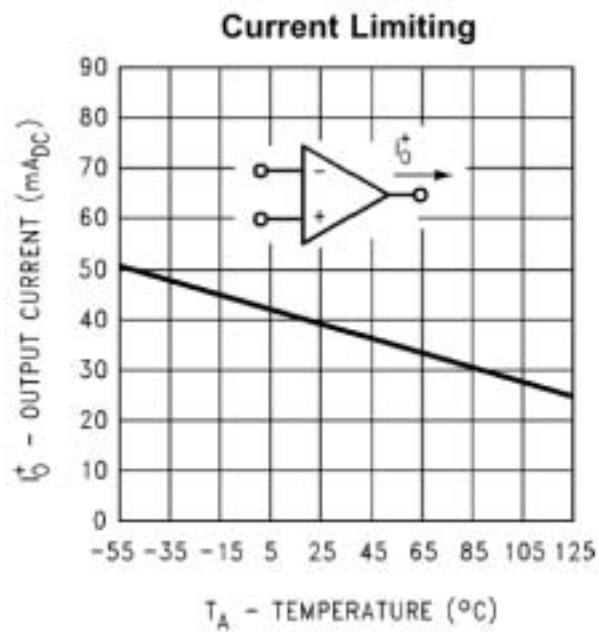
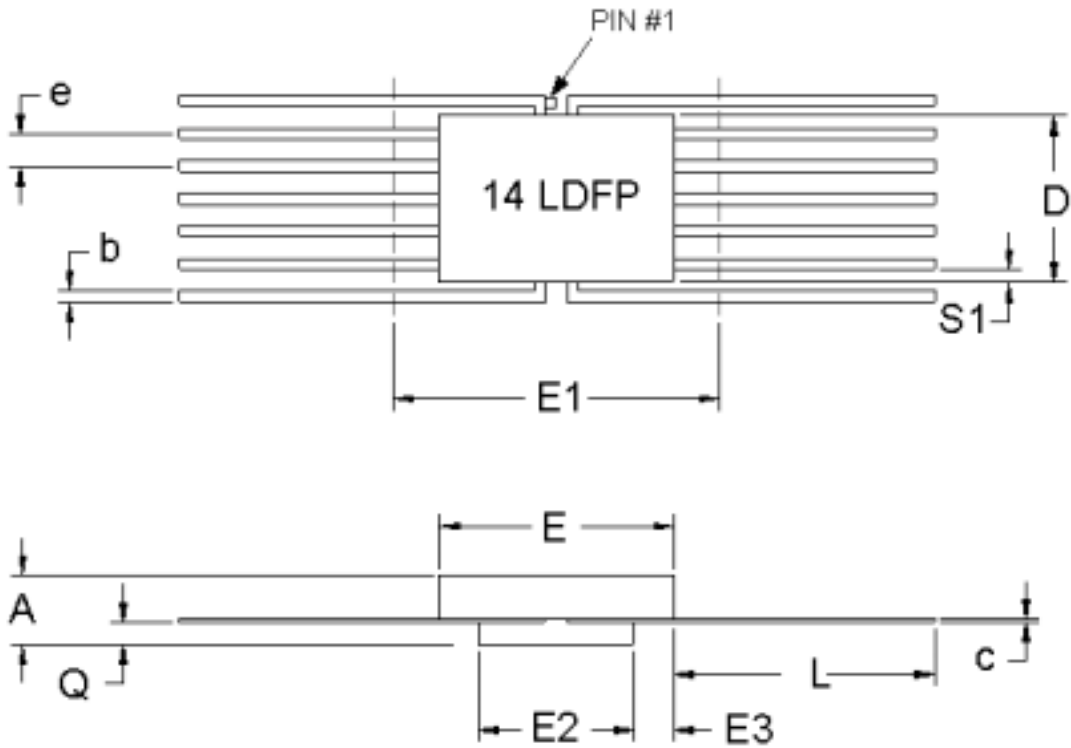

FIGURE 12. CURRENT LIMITING





14-PIN RAK-PAK® FLAT PACKAGE

SYMBOL	DIMENSION		
	MIN	NOM	MAX
A	0.119	0.132	0.145
b	0.010	0.017	0.022
c	0.004	0.005	0.009
D	0.250	0.255	0.260
E	0.250	0.255	0.260
E1	--	--	0.290
E2	0.125	0.135	--
E3	0.030	0.060	--
e	0.050 BSC		
L	0.338	0.348	0.358
Q	0.021	0.025	0.030
S1	0.005	0.019	--
N	14		

F14-03

Note: All dimensions in inches.

Important Notice:

These data sheets are created using the chip manufacturer's published specifications. Maxwell Technologies verifies functionality by testing key parameters either by 100% testing, sample testing or characterization.

The specifications presented within these data sheets represent the latest and most accurate information available to date. However, these specifications are subject to change without notice and Maxwell Technologies assumes no responsibility for the use of this information.

Maxwell Technologies' products are not authorized for use as critical components in life support devices or systems without express written approval from Maxwell Technologies.

Any claim against Maxwell Technologies must be made within 90 days from the date of shipment from Maxwell Technologies. Maxwell Technologies' liability shall be limited to replacement of defective parts.

Product Ordering Options

