

Table 1: Main Features

Symbol	Value	Unit
$I_{T(RMS)}$	40	A
V_{DRM}/V_{RRM}	600 and 800	V
$I_{GT(Q_1)}$	50	mA

DESCRIPTION

Available in high power packages, the **BTA/BTB40-41** series is suitable for general purpose AC switching. They can be used as an ON/OFF function in applications such as static relays, heating regulation, induction motor starting circuits... or for phase control operation in light dimmers, motor speed controllers, ...

Thanks to their clip assembly technique, they provide a superior performance in surge current handling capabilities.

By using an internal ceramic pad, the BTA series provides voltage insulated tab (rated at $2500V_{RMS}$) complying with UL standards (File ref.: E81734).

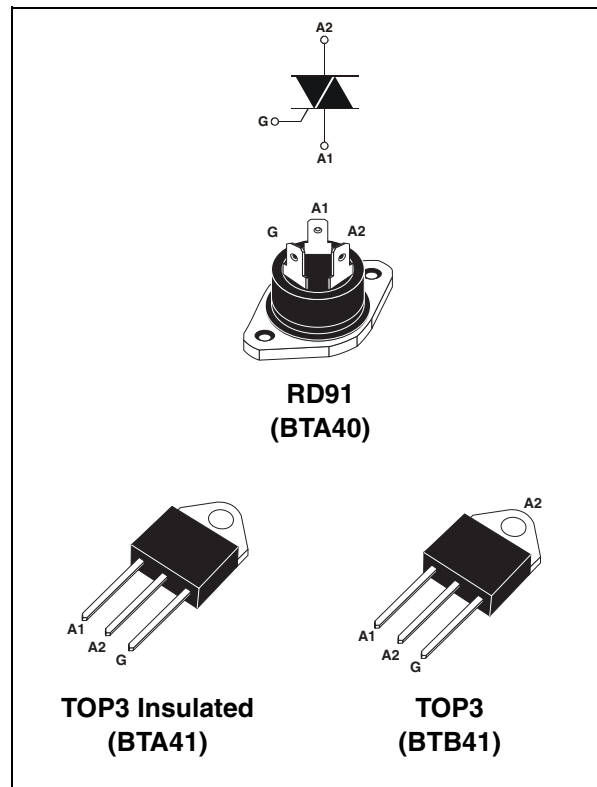
Table 2: Order Codes

Part Number	Marking
BTA40-xxxB	See table 8 on page 6
BTA41-xxxBRG	
BTB41-xxxBRG	

Table 3: Absolute Maximum Ratings

Symbol	Parameter			Value	Unit
$I_{T(RMS)}$	RMS on-state current (full sine wave)	RD91 / TOP3	$T_c = 95^\circ\text{C}$	40	A
		TOP Ins.	$T_c = 80^\circ\text{C}$		
I_{TSM}	Non repetitive surge peak on-state current (full cycle, T_j initial = 25°C)	F = 50 Hz	t = 20 ms	400	A
		F = 60 Hz	t = 16.7 ms	420	
I^2t	I^2t Value for fusing	$t_p = 10$ ms		880	A^2s
di/dt	Critical rate of rise of on-state current $I_G = 2 \times I_{GT}$, $t_r \leq 100$ ns	F = 120 Hz	$T_j = 125^\circ\text{C}$	50	$\text{A}/\mu\text{s}$
V_{DSM}/V_{RSM}	Non repetitive surge peak off-state voltage	$t_p = 10$ ms	$T_j = 25^\circ\text{C}$	$V_{DSM}/V_{RSM} + 100$	V
I_{GM}	Peak gate current	$t_p = 20$ μs	$T_j = 125^\circ\text{C}$	8	A
$P_{G(AV)}$	Average gate power dissipation		$T_j = 125^\circ\text{C}$	1	W
T_{stg} T_j	Storage junction temperature range Operating junction temperature range			- 40 to + 150 - 40 to + 125	$^\circ\text{C}$

Tables 4: Electrical Characteristics ($T_j = 25^\circ\text{C}$, unless otherwise specified)

Symbol	Test Conditions	Quadrant		Value	Unit
I_{GT} (1)	$V_D = 12$ V $R_L = 33$ Ω	I - II - III IV	MAX.	50 100	mA
		ALL	MAX.	1.3	
V_{GT}		ALL	MIN.	0.2	V
V_{GD}	$V_D = V_{DRM}$ $R_L = 3.3$ k Ω $T_j = 125^\circ\text{C}$	ALL	MIN.	0.2	V
I_H (2)	$I_T = 500$ mA		MAX.	80	mA
I_L	$I_G = 1.2$ I_{GT}	I - III - IV II	MAX.	70 160	mA
dV/dt (2)	$V_D = 67\%$ V_{DRM} gate open	$T_j = 125^\circ\text{C}$	MIN.	500	$\text{V}/\mu\text{s}$
(dV/dt) _c (2)	(di/dt) _c = 20 A/ms	$T_j = 125^\circ\text{C}$	MIN.	10	$\text{V}/\mu\text{s}$

Table 5: Static Characteristics

Symbol	Test Conditions			Value	Unit
V_T (2)	$I_{TM} = 60$ A $t_p = 380$ μs	$T_j = 25^\circ\text{C}$	MAX.	1.55	V
V_{t0} (2)	Threshold voltage	$T_j = 125^\circ\text{C}$	MAX.	0.85	V
R_d (2)	Dynamic resistance	$T_j = 125^\circ\text{C}$	MAX.	10	m Ω
I_{DRM} I_{RRM}	$V_{DRM} = V_{RRM}$	$T_j = 25^\circ\text{C}$	MAX.	5	μA
		$T_j = 125^\circ\text{C}$		5	mA

Note 1: minimum I_{GT} is guaranteed at 5% of I_{GT} max.

Note 2: for both polarities of A2 referenced to A1.

Table 6: Thermal resistance

Symbol	Parameter		Value	Unit
$R_{th(j-c)}$	Junction to case (AC)	RD91 (Insulated) / TOP3	0.9	$^{\circ}\text{C}/\text{W}$
		TOP3 Insulated	0.6	
$R_{th(j-a)}$	Junction to ambient	TOP3 / TOP3 Insulated	50	$^{\circ}\text{C}/\text{W}$

S = Copper surface under tab.

Figure 1: Maximum power dissipation versus RMS on-state current (full cycle)

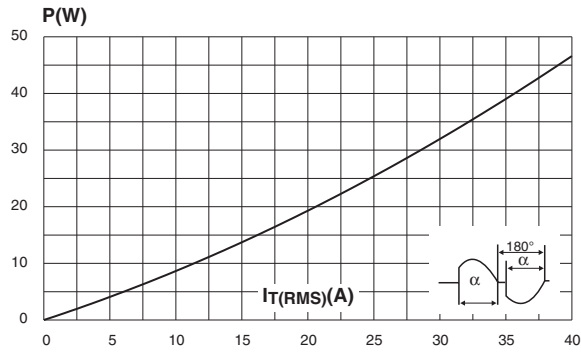

Figure 2: RMS on-state current versus case temperature (full cycle)

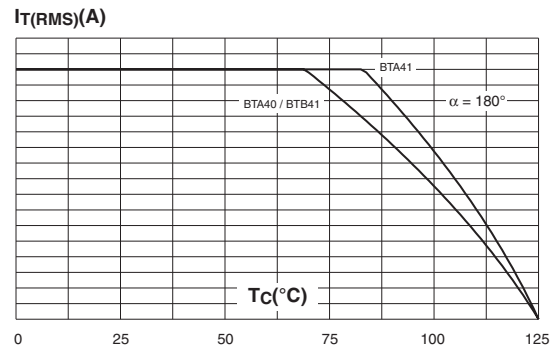

Figure 3: Relative variation of thermal impedance versus pulse duration

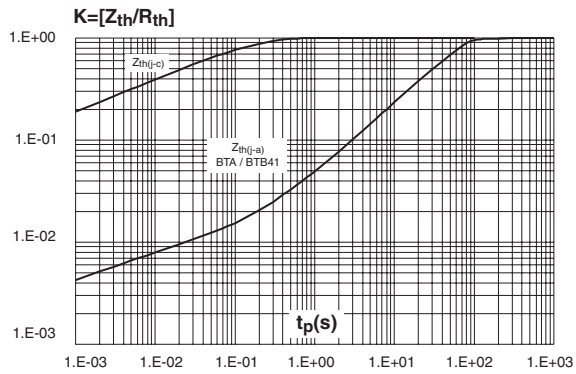

Figure 4: On-state characteristics (maximum values)

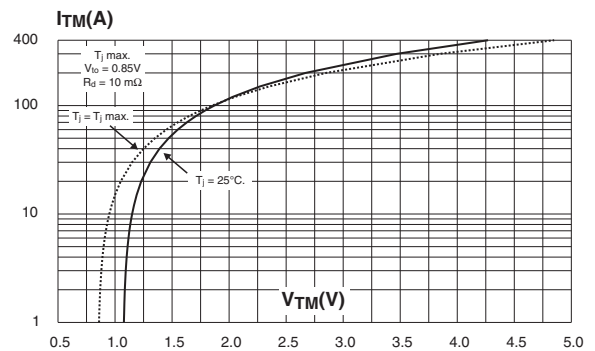

Figure 5: Surge peak on-state current versus number of cycles

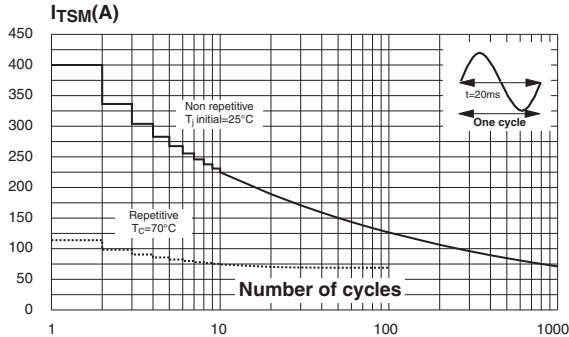

Figure 6: Non-repetitive surge peak on-state current for a sinusoidal pulse with width $t_p < 10$ ms and corresponding value of I^2t

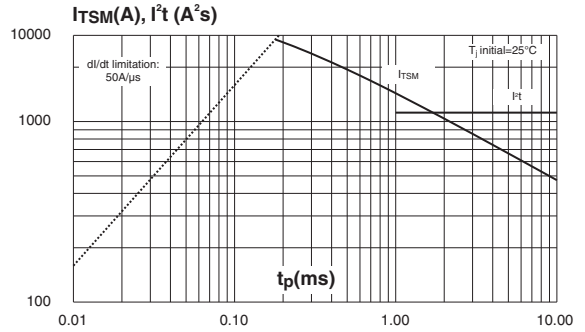

Figure 7: Relative variation of gate trigger current, holding current and latching current versus junction temperature (typical values)

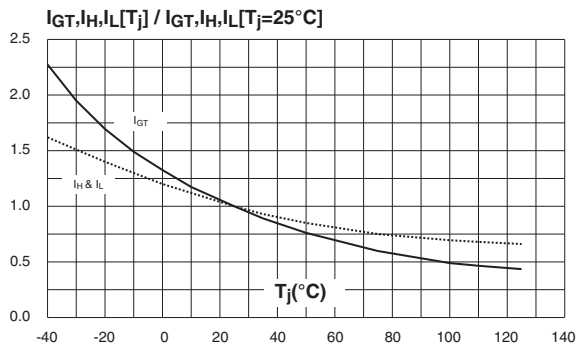

Figure 8: Relative variation of critical rate of decrease of main current versus $(dV/dt)_c$ (typical values)

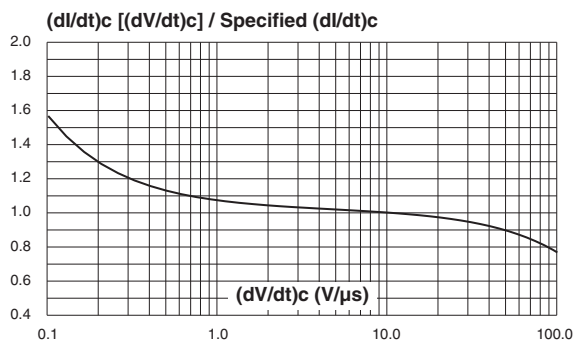

Figure 9: Relative variation of critical rate of decrease of main current versus $(dV/dt)_c$

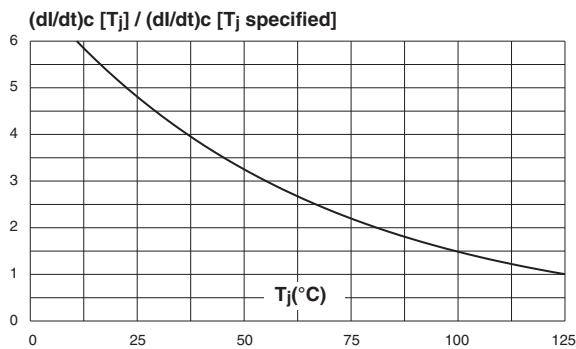

Figure 10: Ordering Information Scheme

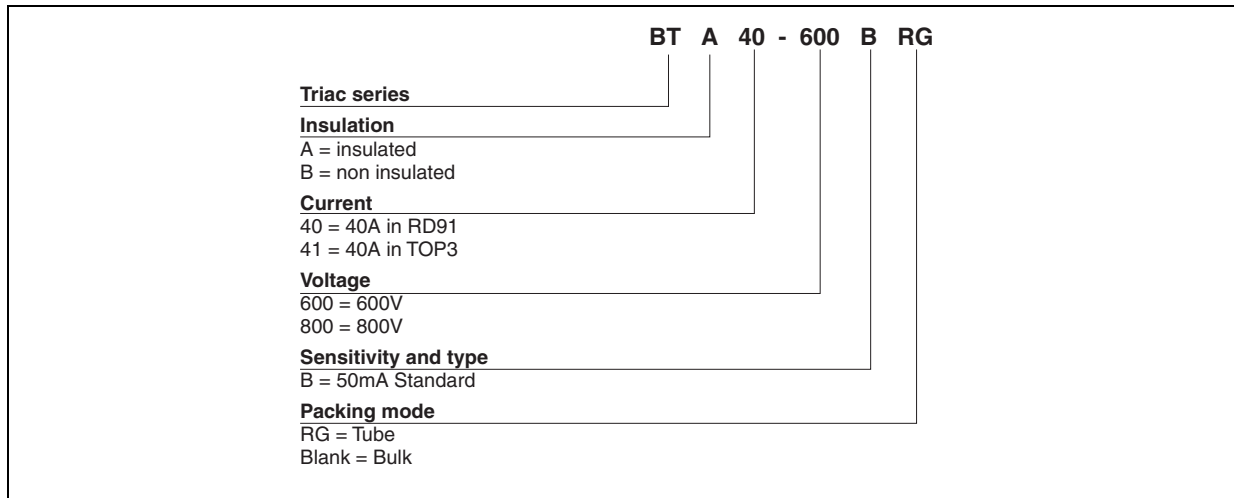

Table 7: Product Selector

Part Numbers	Voltage (xxx)		Sensitivity	Type	Package
	600 V	800 V			
BTA40-xxxB	X	X	50 mA	Standard	RD91
BTA41-xxxBRG	X	X	50 mA	Standard	TOP3 Ins.
BTB41-xxxBRG	X	X	50 mA	Standard	TOP3

BTB: non insulated TOP3 package

Figure 11: TOP3 (Insulated and non insulated) Package Mechanical Data

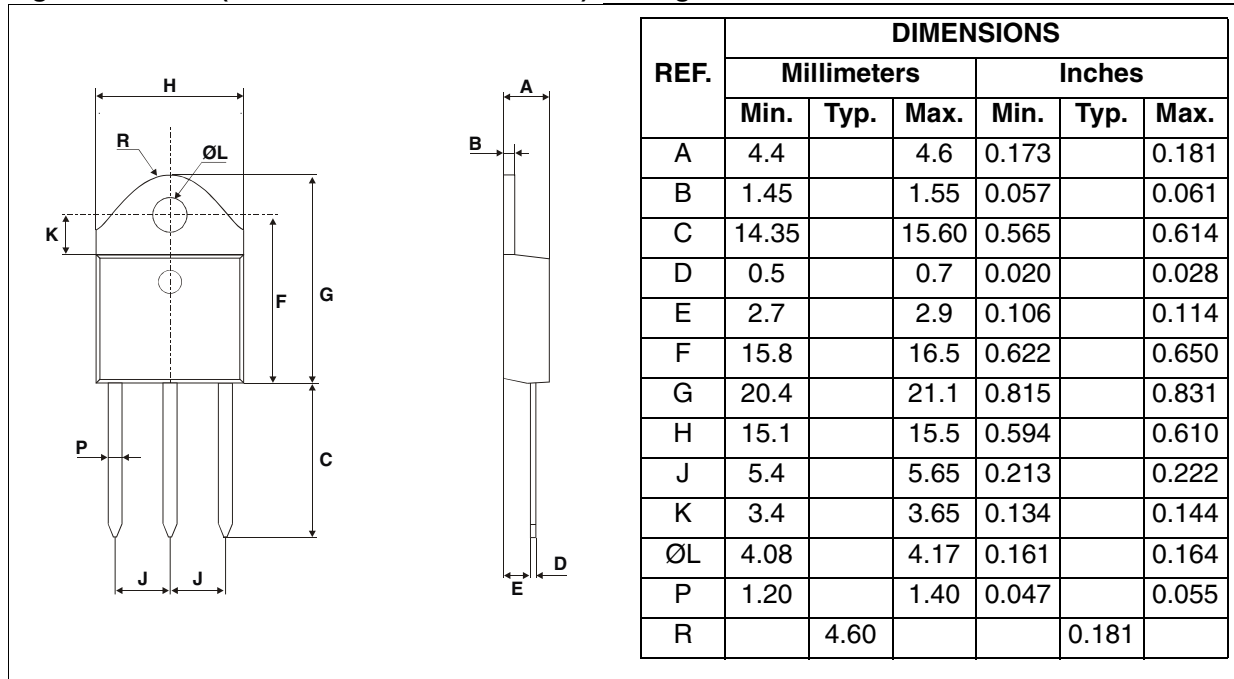

Figure 12: RD91 Package Mechanical Data

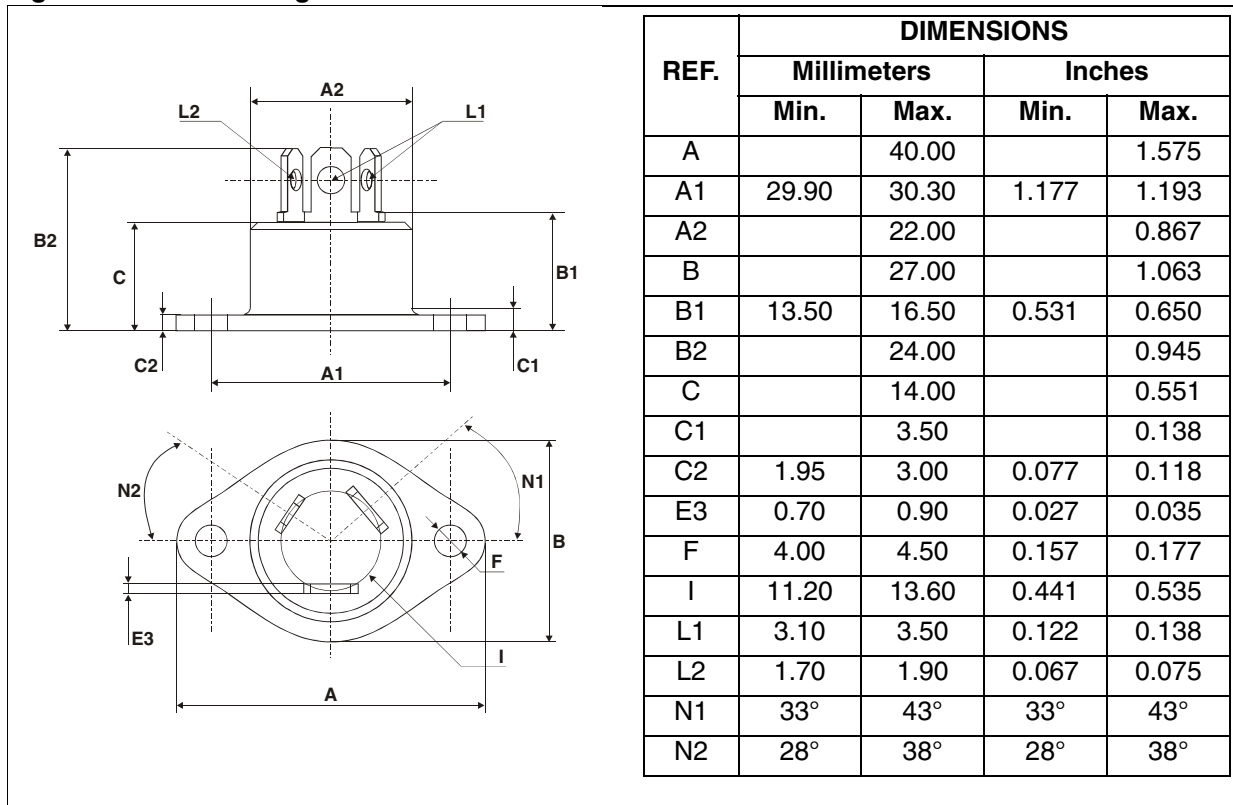

Table 8: Ordering Information

Ordering type	Marking	Package	Weight	Base qty	Delivery mode
BTA40-xxxB	BTA40xxxB	RD91	20 g	25	Bulk
BTA41-xxxBRG	BTA41xxxB	TOP3 Ins.	4.5 g	30	Tube
BTB41-xxxBRG	BTB41xxxB	TOP3	4.5 g	30	Tube

Note: xxx = voltage

Table 9: Revision History

Date	Revision	Description of Changes
Sep-2003	5	Last update.
25-Mar-2005	6	TOP3 delivery mode changed from bulk to tube.
14-Oct-2005	7	T _c values for I _T changed in Table 3. ECOPACK statement added.