



# FKC12 SERIES



### APPLICATIONS

Wireless Network  
Telecom/Datacom  
Industry Control System  
Measurement Equipment  
Semiconductor Equipment

### FEATURES

- 12 WATTS OUTPUT POWER
- OUTPUT CURRENT UP TO 3.5A
- STANDARD 1.25 X 0.80 X 0.40 INCH
- HIGH EFFICIENCY UP TO 88%
- 2:1 WIDE INPUT VOLTAGE RANGE
- FIVE-SIDED CONTINUOUS SHIELD
- FIXED SWITCHING FREQUENCY (400KHz)
- STANDARD 24 PIN DIP PACKAGE
- I/O ISOLATION 1600 VDC
- CE MARK MEETS 2006/95/EC, 93/68/EEC AND 2004/108/EC
- UL60950-1, EN60950-1 AND IEC60950-1 LICENSED
- ISO9001 CERTIFIED MANUFACTURING FACILITIES
- COMPLIANT TO RoHS EU DIRECTIVE 2002/95/EC

### OPTIONS

SMD TYPE

### DESCRIPTION

The FKC12 series offer 12 watts of output power from a package in an IC compatible 24pin DIP configuration. FKC12 series have 2:1 wide input voltage of 9-18, 18-36 and 36-75VDC. The FKC12 have features 1600VDC of isolation, short circuit protection and as well as five sided shielding.

## TECHNICAL SPECIFICATION

All specifications are typical at nominal input, full load and 25°C otherwise noted

OUTPUT SPECIFICATIONS			
Output power			12 Watts, max.
Voltage accuracy	Full load and nominal Vin		±1.2%
Minimum load			0%
Line regulation	LL to HL at Full Load	Single	± 0.2%
		Dual	± 0.5%
Load regulation	No Load to Full Load	Single (DIP)	± 0.5%
		Single (SMD)	± 1%
		Dual (SMD,DIP)	± 1%
		Dual (SMD,DIP) (2.5Vo only)	± 1%
Cross regulation (Dual)	Asymmetrical load 25% / 100% FL		± 5%
Ripple and noise	20MHz bandwidth		See table
Temperature coefficient			±0.02% / °C, max.
Transient response recovery time	25% load step change		250µS
Over voltage protection	2.5V output		3.9VDC
	3.3V output		3.9VDC
	Zener diode clamp	5.1V output	6.2VDC
	(only single)	12V output	15VDC
	15V output		18VDC
Over load protection	% of FL at nominal input		150%, typ.
Short circuit protection		Continuous, automatics recovery	

GENERAL SPECIFICATIONS			
Efficiency			See table
Isolation voltage	Input to Output		1600VDC, min.
	Input(Output) to Case	DIP	1600VDC, min.
		SMD	1000VDC, min.
Isolation resistance			10 <sup>9</sup> ohms, min.
Isolation capacitance			1200pF, max.
Switching frequency			400KHz, typ.
Approvals and standard		IEC60950-1, UL60950-1, EN60950-1	
Case material		Nickel-coated copper	
Base material		Non-conductive black plastic	
Potting material		Epoxy (UL94-V0)	
Dimensions		1.25 X 0.80 X 0.40 Inch (31.8 X 20.3 X 10.2 mm)	
Weight			18g (0.62oz)
MTBF (Note 1)	BELLCORE TR-NWT-000332		2.750 x 10 <sup>6</sup> hrs
	MIL-HDBK-217F		7.575 x 10 <sup>5</sup> hrs

INPUT SPECIFICATIONS			
Input voltage range	12V nominal input		9 – 18VDC
	24V nominal input		18 – 36VDC
	48V nominal input		36 – 75VDC
Input filter			Pi type
Input surge voltage	12V input		36VDC
	24V input		50VDC
	100mS max	48V input	100VDC
Input reflected ripple current	Nominal Vin and full load		20mAp-p
Start up time	Nominal Vin and constant resistive load	Power up	450mS, max.
Start-up voltage	12V input		9VDC
	24V input		18VDC
	48V input		36VDC
Shutdown voltage	12V input		8VDC
	24V input		16VDC
	48V input		33VDC
Remote ON/OFF (Note 6) (Positive logic)	DC-DC ON	Open or 3.0V < Vr < 12V	
		Short or 0V < Vr < 1.2V	
	DC-DC OFF		
Input current of remote control pin	Nominal Vin		-0.5mA ~ 0.5mA
Remote off state input current	Nominal Vin		2.5mA

ENVIRONMENTAL SPECIFICATIONS			
Operating ambient temperature			-40°C to +85°C (with derating)
Maximum case temperature			100°C
Storage temperature range			-55°C to +105°C
Thermal impedance	Nature convection		20°C/Watt
Thermal shock			MIL-STD-810F
Vibration			MIL-STD-810F
Relative humidity			5% to 95% RH

EMC CHARACTERISTICS			
EMI (Note 7)	EN55022		Class A
ESD	EN61000-4-2	Air	± 8KV
		Contact	± 6KV
Radiated immunity	EN61000-4-3	10 V/m	Perf. Criteria A
Fast transient (Note 8)	EN61000-4-4	± 2KV	Perf. Criteria A
Surge (Note 8)	EN61000-4-5	± 1KV	Perf. Criteria A
Conducted immunity	EN61000-4-6	10 Vr.m.s	Perf. Criteria A





**12WATTS OUTPUT  
DC-DC CONVERTER**

Model Number	Input Range	Output Voltage	Output Current		Output (4) Ripple & Noise	Input Current		Eff (4) (%)	Capacitor(5) Load max
			Min. load	Full load		No load (3)	Full load (2)		
FKC12-12S2P5	9 – 18 VDC	2.5 VDC	0mA	3500mA	85mVp-p	50mA	935mA	82	2000µF
FKC12-12S3P3	9 – 18 VDC	3.3 VDC	0mA	3500mA	85mVp-p	60mA	1203mA	84	2000µF
FKC12-12S05	9 – 18 VDC	5.1 VDC	0mA	2400mA	85mVp-p	53mA	1244mA	86	2000µF
FKC12-12S12	9 – 18 VDC	12 VDC	0mA	1000mA	85mVp-p	15mA	1219mA	86	430µF
FKC12-12S15	9 – 18 VDC	15 VDC	0mA	800mA	85mVp-p	17mA	1219mA	86	300µF
FKC12-12D05	9 – 18 VDC	± 5 VDC	0mA	± 1200mA	85mVp-p	24mA	1282mA	82	± 1250µF
FKC12-12D12	9 – 18 VDC	± 12 VDC	0mA	± 500mA	85mVp-p	19mA	1205mA	87	± 200µF
FKC12-12D15	9 – 18 VDC	± 15 VDC	0mA	± 400mA	85mVp-p	24mA	1205mA	87	± 120µF
FKC12-24S2P5	18 – 36 VDC	2.5 VDC	0mA	3500mA	85mVp-p	36mA	461mA	83	2000µF
FKC12-24S3P3	18 – 36 VDC	3.3 VDC	0mA	3500mA	85mVp-p	36mA	594mA	85	2000µF
FKC12-24S05	18 – 36 VDC	5.1 VDC	0mA	2400mA	85mVp-p	35mA	614mA	87	2000µF
FKC12-24S12	18 – 36 VDC	12 VDC	0mA	1000mA	85mVp-p	16mA	602mA	87	430µF
FKC12-24S15	18 – 36 VDC	15 VDC	0mA	800mA	85mVp-p	17mA	602mA	87	300µF
FKC12-24D05	18 – 36 VDC	± 5 VDC	0mA	± 1200mA	85mVp-p	15mA	633mA	83	± 1250µF
FKC12-24D12	18 – 36 VDC	± 12 VDC	0mA	± 500mA	85mVp-p	15mA	595mA	88	± 200µF
FKC12-24D15	18 – 36 VDC	± 15 VDC	0mA	± 400mA	85mVp-p	18mA	595mA	88	± 120µF
FKC12-48S2P5	36 – 75 VDC	2.5 VDC	0mA	3500mA	85mVp-p	10mA	231mA	83	2000µF
FKC12-48S3P3	36 – 75 VDC	3.3 VDC	0mA	3500mA	85mVp-p	14mA	297mA	85	2000µF
FKC12-48S05	36 – 75 VDC	5.1 VDC	0mA	2400mA	85mVp-p	23mA	307mA	87	2000µF
FKC12-48S12	36 – 75 VDC	12 VDC	0mA	1000mA	85mVp-p	11mA	301mA	87	430µF
FKC12-48S15	36 – 75 VDC	15 VDC	0mA	800mA	85mVp-p	5mA	301mA	87	300µF
FKC12-48D05	36 – 75 VDC	± 5 VDC	0mA	± 1200mA	85mVp-p	6mA	316mA	83	± 1250µF
FKC12-48D12	36 – 75 VDC	± 12 VDC	0mA	± 500mA	85mVp-p	6mA	297mA	88	± 200µF
FKC12-48D15	36 – 75 VDC	± 15 VDC	0mA	± 400mA	85mVp-p	6mA	297mA	88	± 120µF

**NOTE:**

- BELLCORE TR-NWT-000332. Case 1: 50% Stress, Temperature at 40°C.  
MIL-HDBK-217F Notice2 @Ta=25 °C, Full load(Ground, Benign, controlled environment).
- Maximum value at nominal input voltage and full load of standard type.
- Typical value at nominal input voltage and no load.
- Typical value at nominal input voltage and full load.
- Test by minimum Vin and constant resistive load.
- The ON/OFF control pin voltage is referenced to -Vin.
- The FKC12 series can meet EN55022 Class A with parallel an external capacitor to the input pins.  
Recommend: 12Vin : 6.8µF/50V 1812 MLCC .  
24Vin : 4.7µF/50V 1812 MLCC .  
48Vin : 2.2µF/100V 1812 MLCC.
- An external input filter capacitor is required if the module has to meet EN61000-4-4, EN61000-4-5.  
The filter capacitor Power Mate suggest: Nippon chemi-con KY series, 220µF /100V, ESR 48mΩ .

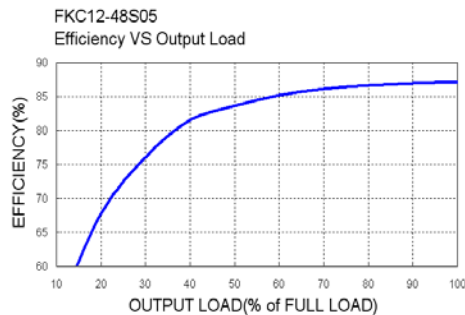
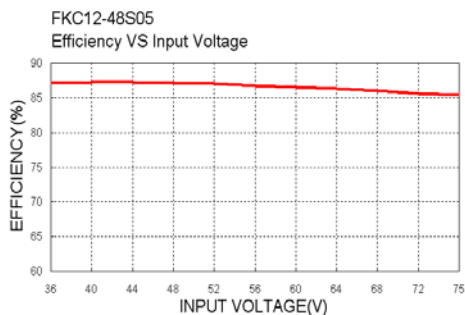
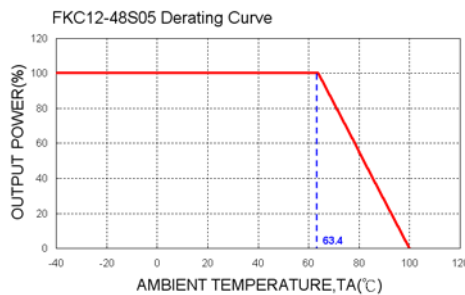



**12WATTS OUTPUT  
DC-DC CONVERTER**

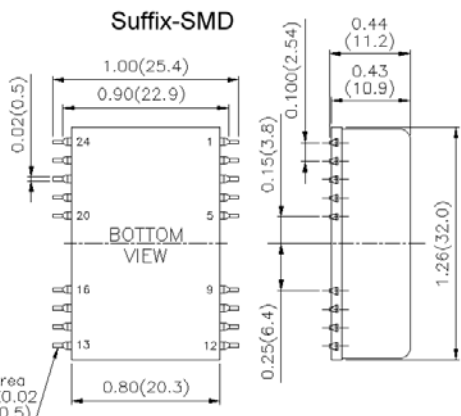
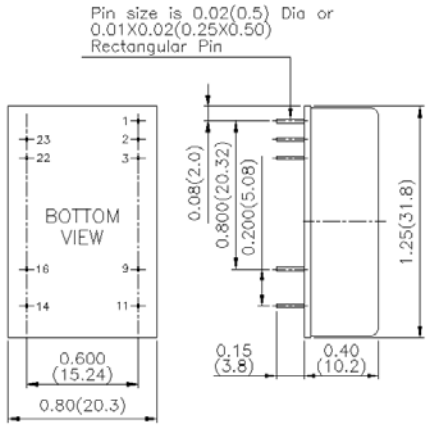

- All dimensions in Inches (mm)  
Tolerance: X.XX±0.02 (X.X±0.5)  
X.XXX±0.01 (X.XX±0.25)
- Pin pitch tolerance ±0.01(0.25)
- Pin dimension tolerance ±0.004 (0.1)

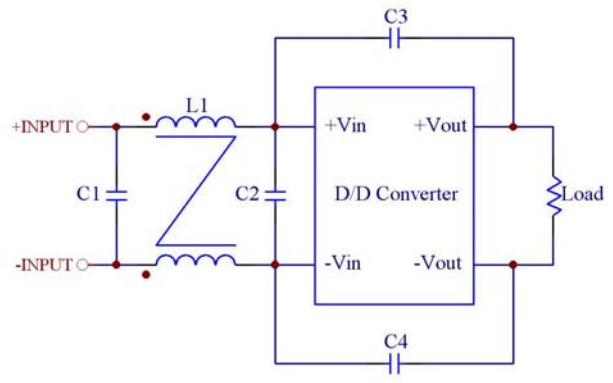

**Recommended Filter for EN55022 Class B Compliance**

The components used in the above figure, together with the manufacturers' part numbers for these components, are as follows:

	C1	C2	C3	C4	L1
FKC12-12xxx	3.3µF/50V 1812 MLCC	N/A	1000pF/2KV MLCC	1000pF/2KV MLCC	325µH Common Choke PMT-050
FKC12-24xxx	4.7µF/50V 1812 MLCC	N/A	1000pF/2KV MLCC	1000pF/2KV MLCC	325µH Common Choke PMT-050
FKC12-48xxx	2.2µF/100V 1812 MLCC	2.2µF/100V 1812 MLCC	1000pF/2KV MLCC	1000pF/2KV MLCC	325µH Common Choke PMT-050

**DIP PIN CONNECTION**

PIN	SINGLE	DUAL	PIN	SINGLE	DUAL
1	CTRL	CTRL			
2	- INPUT	- INPUT	23	+ INPUT	+ INPUT
3	- INPUT	- INPUT	22	+ INPUT	+ INPUT
9	NC	COMMON	16	- OUTPUT	COMMON
11	NC	- OUTPUT	14	+ OUTPUT	+ OUTPUT

**SMD PIN CONNECTION**

PIN	SINGLE	DUAL	PIN	SINGLE	DUAL
1	CTRL	CTRL			
2	- INPUT	- INPUT	23	+ INPUT	+ INPUT
3	- INPUT	- INPUT	22	+ INPUT	+ INPUT
9	NC	COMMON	16	- OUTPUT	COMMON
11	NC	- OUTPUT	14	+ OUTPUT	+ OUTPUT
Others	NC	NC	Others	NC	NC

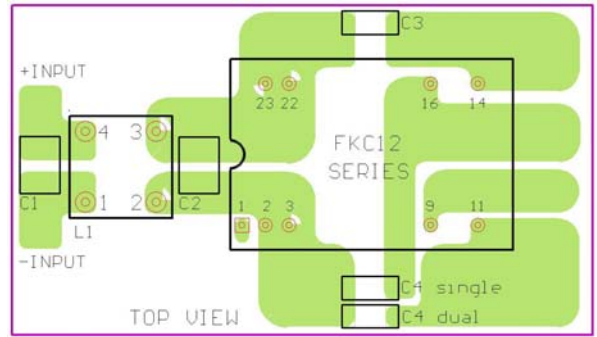

**Recommended EN55022 Class B Filter Circuit Layout**

